

Index

	Page #
Introduction -----	2
Executive Summary-----	5
Kenai Peninsula Borough	
Sales - KPB Finance Department-----	11
Construction – City administrations throughout KPB -----	25
Employment St of AK, Dept of Labor & Workforce Development-----	37
Population – U.S. Census Bureau -----	42
Homer	
Sales - KPB Finance Department-----	47
Construction – City of Homer -----	53
Cost of Food – University of Alaska Fairbanks Cooperative Extension -----	59
Kenai	
Sales - KPB Finance Department-----	61
Construction – City of Kenai-----	67
Cost of Food – University of Alaska Fairbanks Cooperative Extension -----	73
Seldovia	
Sales - KPB Finance Department-----	75
Construction – City of Seldovia -----	81
Seward	
Sales - KPB Finance Department-----	85
Construction – City of Seward-----	91
Cost of Food – University of Alaska Fairbanks Cooperative Extension -----	97
Soldotna	
Sales - KPB Finance Department-----	99
Construction – City of Soldotna -----	105
Cost of Food – University of Alaska Fairbanks Cooperative Extension -----	111
Other	
Sales – KPB Finance Department -----	113
Directory of Local Officials-- -----	119
Data Sources are listed for each subsection.	

Introduction

Kenai Peninsula Borough (KPB) staff develops quarterly reports containing economic data from throughout the area for use by businesses, agencies, and other entities to aid in planning and management decisions.

The publication is divided into eight sections: Kenai Peninsula Borough, Homer, Kenai, Seldovia, Seward, Soldotna, KPB Unincorporated and a Local Officials Directory.

To provide unity within the document, certain conventions are applied:

- In the real estate section, the following abbreviations apply:
 - RN - Residential New
 - RA - Residential Alteration/Addition
 - CN - Commercial New
 - CA - Commercial Alteration/Addition

- In Sales sections, the following industry abbreviations apply:
 - AFF – Agriculture, Forestry and Fisheries (Includes Fish Buyers)
 - Min – Mining (Includes Oil & Gas Extraction and Production)
 - Const – Construction
 - Manu – Manufacturing (Includes Oil & Gas Manufacturing and Fish Processing)
 - TCPU – Travel, Communications, and Public Utilities
 - Whole – Wholesale Trade
 - Retail – Retail Trade
 - FIRE – Finance, Insurance and Real Estate
 - Service – Services
 - Govt – Public Administration, Education and Service

- Information sources for each section are listed in the index.

- General information applicable to all sections is provided in the Kenai Peninsula Borough section.

- Percentages of parts may not total 100%, due to rounding.

Information presented will assist in decision-making by providing economic and demographic information in graphic, table and text form. Local and state government officials; local, state and federal agencies; businesses within the KPB and elsewhere; and private citizens use data contained in the publication.

Data is received from various sources and is subject to change as updates, revisions and corrections are received. The KPB makes no claims to accuracy or completeness of information provided. Only summary information is published. For further detail, contact Jeanne Camp, Economic Analyst, KPB Community and Economic Development Division, 907-714-2336, or the data source listed in the index.

Reports are available electronically at <http://www.borough.kenai.ak.us>, the KPB website. Select the Economic Development department, Economic Indicators, Publications.

To correct your mailing address or to be added to or deleted from the mailing list for this report, please email jcamp@borough.kenai.ak.us or call 907-714-2336. Be certain to identify yourself and the complete mailing address to be added or deleted. For additions, an email address is appreciated to be used for notification of data errors.

The Kenai Peninsula Borough wishes to thank all entities listed below for data provided for this publication.

Alaska Department of Labor and Workforce Development (AK DOLWD)
City of Homer
City of Kenai
City of Seward
City of Soldotna

Kenai Peninsula Borough Finance Department, Sales Tax Division
University of Alaska Fairbanks Cooperative Extension

The writer wishes to thank those persons who gave of their time to review this document, finding errors and making suggestions that result in a more professional and accurate document. Those individuals include Jack Brown, Business Manager of the KPB Community and Economic Development Division; Betty Glick, KPB Assembly member; Debbie Brown, KPBSD Board Member; Jane Stein, Soldotna City Council Member and Sylvia Vinson, KPB Planning Department.

Functions of the CEDD and the EDD

Frequent questions regarding differences between KPB Community Economic Development Division (CEDD) and the Economic Development District (EDD) suggest the need for an explanation. The table below defines the differences.

	CEDD	EDD
Funding	Funded by KPB, federal and state grants	Funded by grants – federal, state, borough
Powers	Non area-wide economic development power, only unincorporated areas	Borough-wide economic development powers
Projects	Works on special projects for the mayor	Assists in KPB long-term economic planning
	Develops, monitors KPB grant funding	Sponsors community economic forums
	Publishes historical/current economic data	Assists in community strategic planning
	Oil and Gas liaison	

What is a “Moving Average Trendline?”

Charts in economic reports frequently include “moving average trendlines.” A description of “trendline” is in order.

The purpose of a trendline is to demonstrate the average of data groupings and how that average relates to averages of similar groupings within the chart.

Imagine that a bar chart illustrates twelve quarters of data. The trendline begins at the fourth entry in the series and marks the point representing the average of the first through the fourth numbers in the series, in this case a 1st, 2nd, 3rd and 4th quarter value, one year. The trendline continues to the right in the chart. As the trendline reaches the next data point in the series, the trend line will move to the point on the scale representing the average of the second through the fifth entries in the series – still four quarters of data, but this time those values would be the 2nd, 3rd and 4th quarter of the first year plus the 1st quarter of the second year.

The process continues through the chart. As the line moves through the chart, it drops the entry marking the beginning of the trend point average, adds the entry just ahead of the previous set of four and indicates the average of the new set of four numbers in the series. The resulting “smoothing” effect allows the reader to more easily see change from one year to the next.

Executive Summary

At the conclusion of forty years of existence, the Kenai Peninsula Borough saw gross sales for 2004 breaking the two billion dollar mark with total reported gross sales of \$2,059,706,931, a 7.3% gain for the year. Both gross and taxable sales mark quarterly gains as gross sales were 16.7% above fourth quarter gross sales for 2003. Taxable sales for the quarter were up 3.7%, and gained 6.1% for the year.

Construction permitting resulted in values 28.1% greater than during fourth quarter of 2003 and 92.7% greater for the year than during 2003. Volume for the quarter was down 14.5%, indicating larger projects are being permitted. For the year, permit volume dropped 7.1%.

December's employment was 559 persons greater than one year ago, with 18,338 persons employed. The labor force increased by 166 persons to 20,803. The resultant decrease in the unemployment rate, 11.8%, was two percentage points less than one year ago, and nearly three percentage points less than two years ago. An increase in labor force is positive when new jobs are available for each person added to the labor force. KPБ's 2004 monthly average labor force increased over 2003 levels by 556 persons while jobs increased by 799 positions. The resultant annual average unemployment rate, 10.9% during 2004, was down from the 2003 average of 12.3%. During the average month of 2004, there were 2,456 unemployed persons in the KPБ, compared to 2,699 during 2003, a drop of 243 persons.

The mining and gas industry remains in the forefront of KPБ economic activity. Pebble Mine, while not located within the KPБ, will certainly have an impact on the KPБ economy as support industries, transportation centers, and the local labor force help supply the developing project needs. Relief associated with the settlement between Agrium and Unocal was followed almost immediately by the announcement that the Agrium plant will shut down as of October 31, 2005, when Unocal will no longer be supplying gas for continued operation.

General consensus indicates plentiful undiscovered gas in the Cook Inlet Basin, with new wells being planned, permitted or drilled. The year 2004 ended with greater known reserves than were known at the beginning of the year, due to exploration. Oil is also found in the Cook Inlet, though less plentiful than gas. As of November 5, 2004, gas is flowing from the Deep Creek Unit, into the Kenai-Kachemak pipeline. The industry's focus continues to be natural gas exploration and reworking of existing fields. Industry issues include sufficiency of gas to support Agrium and ConocoPhillips operations, utility and personal uses; gas storage to meet requirements on high usage days; and aging workforce issues.

SALES

Fourth quarter 2004 gross sales of \$535,181,105 were 16.7% greater than the \$458,574,141 in sales occurring during 2003, a difference of \$73,606,964. Taxable sales increased 3.7% from \$156,625,930 during 2003 to \$162,377,714 during the most recent fourth quarter, with five of ten sectors experiencing gains, and five losing sales.

The mining sector includes oil and gas extraction; manufacturing includes fish processing and value-added processing of oil and gas products. Agriculture, Forestry and Fishing (AFF) includes fish buyers.

Quarterly Sales

Gross by Industry. Eight of ten industry sectors tracked by the KPB reported gains. Construction industry gross sales increased \$32,565,024 or 49.9% for the quarter, reaching \$97,853,217. Mining sales increased \$20,953,294 or 65.8%, to total \$52,804,226. Transportation, Communication and Public Utilities (TCPU) sales totaled \$50,955,584, up 35.9% or \$13,461,655. Service industry sales gained 23.4% to reach \$62,323,056, a \$11,821,408 increase. The large retail sector increased sales by \$9,601,842 to total \$158,650,071, a 6.4% gain. Sale of wholesale goods increased 18.3%, or \$8,503,455 to total \$55,086,960. Finance, Insurance and Real Estate (FIRE) sales also experienced gains, 37.1% or \$5,552,835, with a total of \$20,509,456 in gross sales. Agriculture, Forestry and Fishing (AFF) sales increased 130.8% or \$3,207,658 with \$5,660,166 in sales.

Manufacturing sales of \$31,334,632 were down 48.1% from 4th quarter 2003, a \$29,055,155 decline. The drop in government sales, 57.5% is inconsequential with sales of \$3,737 of the total \$535,181,105 gross sales in the Borough. (See page 15 for detail.)

Taxable by Industry. Taxable sales for fourth quarter were 3.7% greater than sales of fourth quarter 2003. The greatest percentage gain came as mining sales increased 25.2% to \$1,460,913. FIRE sales also marked a double-digit gain, 14.3%, for \$5,721,949 in sales. TCPU sales, gaining 5.5% in taxable sales, reached \$20,771,617 in sales. The 4.2% increase in retail sales is equivalent to a \$4,078,516 gain, with total sales of \$101,882,441. Construction sales increased 2.5% to \$2,841,221.

Five of ten sectors experienced sales declines but the 57.5% decline in government sales is inconsequential in the total picture of \$162,377,714, with \$3,737 in sales. Quarterly taxable manufacturing sales declined 6.2% to \$1,744,372 while sale of wholesale goods dropped 3.3% to \$5,561,924. AFF sales decreased 1.6% to \$957,803. Lastly, the second largest sector, services, reported sales of \$21,431,737, down 0.8%. (See page 16 for detail.)

Gross by Area. All areas experienced sales increases for the quarter. Seldovia gross sales increased 60.5% with sales of \$3,129,207. Seward sales of \$38,561,236 marked a 41.1% gain while Homer's \$72,065,062 in sales were 19.7% greater than 2003 fourth quarter sales. Soldotna sales totaled \$92,685,505, a 12.8% increase over a year ago. Kenai, with sales of \$72,566,317, increased sales by \$20,507 or 0.03%. The large unincorporated area had a sales increase of 19.5% and totaled \$256,173,778. (See detail on page 17.)

Taxable by Area. Taxable sales percentage gains were less than gross sales, but all areas except Seward experienced increases. Kenai sales marked the greatest percentage gain, 12.7%, reaching \$32,782,140. Seldovia sales increased 2.1%, with sales of \$689,034. Sales in Homer increased 0.7% to \$27,272,024 while Soldotna sales increased 0.4% to \$46,724,370. Finally, sales in the unincorporated area of the KPB increased 4.0% to total \$44,635,676.

Seward's 0.2% decline saw sales drop to \$10,274,470. (See detail on page 18.)

Annual Sales

KPB 2004 annual gross sales of \$2,059,706,931 were 7.3% above those of 2003 as seven sectors improved sales and three had declining sales. Each of the five cities reported annual increases. Total 2003 sales of \$1,919,410,900 were 2.2% greater than 2002 sales of \$1,877,961,633.

Taxable sales increased 6.1% from 2003 to 2004 with sales of \$777,606,896, following a 2.6% increase from 2001 to the 2002 level of \$724,232,961 and 1.2% from 2002 to 2003 when sales totaled \$732,698,621. Each reporting area and each industry, with the exception of the minimal government sales, had increased taxable sales during 2004.

Gross by Industry. Annual gross sales for 2004 increased 7.3%, led by mining industry sales of \$163,704,724, which gained 53.6% over 2003. The AFF sector gained 25.4%, with sales of \$27,600,197 and TCPU sales of \$180,587,427 were 14.0% greater than the previous year. Services increased sales 13.7% with sales of \$316,292,402 while FIRE increased sales 12.3% to reach \$65,169,307. The large retail sector gained 8.2%, or \$52,698,457, to total \$697,393,919. Sale of wholesale goods increased 4.5% to \$202,865,950.

Manufacturing sales experienced the greatest percentage loss, 14.7%, from 2003 with sales dropping to \$170,189,095. Construction sales decreased 8.6% to \$235,868,805. Negligible government sales decline, 16.4%, to \$35,105. (See detail on page 19.)

Taxable by Industry. Only government sector sales declined for the year, all other sectors marked gains, providing an overall 6.1% increase. Retail sales increased \$31,218,799, or 7.3%, reaching \$460,484,927. Service sales increased \$9,421,364 to total \$154,138,882, a 6.5% gain. Another million-dollar gainer, sale of wholesale goods, had sales of \$25,574,064,

increasing 5.9%, up \$1,434,609. Mining sales were up 12.6% to \$5,499,300 and AFF sales increased 9.6% to \$5,494,205. Taxable manufacturing sales increased 6.5% and totaled \$9,837,983 for the year while TCPU sales increased 1.2% to \$82,312,722. Gaining less than 1% were construction sales of \$11,281,948, up 0.1% and FIRE sales of \$22,947,825, up 0.9%.

Government's 16.5% sales decrease is negligible at \$35,040. (See detail on page 20)

Gross by Area. All areas reported increased sales with Seldovia gross sales expanding 33.1%, reaching \$9,662,317 for the year, with strong growth in AFF, FIRE and service sectors. Kenai, with \$308,173,470 in sales, marked an 8.8% gain. Soldotna sales increased 6.8% while Seward sales increased 6.6% to reach \$360,824,580 and \$167,348,329, respectively. Homer increased gross sales 3.9% to \$284,212,220. The unincorporated region reported sales of \$929,486,015, an 8.0% increase over 2003. (See detail on page 21.)

Taxable by Area. Kenai sales increased 14.4% to \$138,869,827, a factor of Home Depot's first full year of operation. Homer sales gained 6.1% to total \$139,700,742. Soldotna sales of \$199,135,668 marked a 4.5% increase as Seward sales increased 4.3% with reported sales of \$79,639,924. Sales in the unincorporated area grew 3.6% to \$216,883,248. Lastly, Seldovia sales of \$3,377,487 were up 0.02%, or \$543. (See detail on page 22.)

CONSTRUCTION PERMITTING

Quarterly Permitting

There were 53 construction permits issued in KPB cities during fourth quarter 2004, a 16.1% decrease from fourth quarter 2003 when 62 permits were issued. Total value of those permits was \$8,939,496, up 28.1% from the same period of 2003 when permit values totaled \$6,980,445. Data in this section does not include construction activity outside incorporated cities of Homer, Kenai, Seldovia, Seward and Soldotna because the KPB does not require building permits. Note that Seward data has been revised for the past quarters.

By Area, Value. Soldotna permits provided 52.6% of value for the quarter, issuing permits with values totaling \$4,703,915. Homer permit values of \$3,391,000, were 37.9% of the borough-wide total. Kenai's \$585,400 in value and Seward's \$259,350 in value added 6.5% and 2.9% of the total, respectively. Seldovia issued no permits. (See detail on page 25.)

By Type, Value. Commercial alteration/addition permit values totaled \$4,194,750 for 46.9% of the quarterly total value. New commercial permits followed closely with 34.2% of the total with \$3,061,601 in value. New residential permit values totaled \$1,153,860 during fourth quarter 2004, 12.9% of total permit value. Finally, with 5.9% of the total, residential alteration permits totaled \$529,454. (See detail on page 26)

By Area, Volume. Issuing 24 permits, Homer was the most active permitting area, with 45.3% of the total. Kenai issued 14 permits, 26.4% of the quarterly total. Soldotna issued eight permits while Seward finished the quarter having issued seven permits, 15.1% and 13.2% respectively. Seldovia did not issue any permits but reports substantial construction activity outside the city limits. (See detail on page 27.)

By Type, Volume. Permitting during fourth quarter resulted in residential alteration/addition permits providing 32.7% of the total, 17 permits. Nine new commercial permits were issued, 26.9% of the quarterly total. New residential permitting provided 17% of the total, eleven permits, while ten permits were issued for commercial alteration/addition projects, 30.2%. (See detail on page 28.)

Annual Construction - Year 2004

Construction permits are required by KPB cities, but not by the KPB, resulting in incomplete KPB construction activity data, but complete activity within the cities. Total permit values during 2004 were \$84,041,457, a 92.7% increase over 2003, the highest total value on record, overcoming the 1995 total when Seward's SeaLife center was permitted for a total \$61,510,032 for all permits issued.

There were 312 permits issued during 2004, 7.1% less than the 336 issued during 2003, and tying for third highest on record.

By Area, Value. Soldotna permitted the \$21,384,000 addition to Central Peninsula General Hospital, a Fred Meyer alteration, Trustworthy Hardware's new facility, and numerous others. The total \$37,296,926 in permitted projects during 2004 was 44.4% of the KPB annual total. Homer, with a total permit value of \$24,070,631, provided 28.6% of the total value. Seward issued permits totaling \$17,711,150; Kenai had a total of \$4,786,550 in permit value; and the remote community of Seldovia issued \$176,200 in permit values.

Soldotna values were 369% greater than those of 2003. Seward saw a 121.9% increase and Homer had 57.0% growth. Kenai values decreased 54.2% and Seldovia values were down 90.7% from 2003. (See detail on page 29.)

By Type, Value. With \$56,079,343 in permitting, new commercial activity provided 66.7% of project assessed value. New residential activity provided 19.0% of permit value, \$15,935,344. Commercial alteration/addition permit values totaled \$9,146,486, 10.9% of the total. Finally, residential alteration/addition permits added \$2,880,284 for 3.4% of the KPB annual total.

New residential values increased 1.3% and residential alteration/addition increased value 26.3% for the year. New commercial values gained 254.5% but commercial alteration/addition total value was down 6.4%. (See detail on page 32.)

By Area, Volume. There were 312 permits issued for construction projects in KPB cities during 2004. Homer issued 108 permits, 34.6% of the total, increasing 25.6% over 2003. Kenai's 79 permits provided 25.3% of the KPB total and marked a 30.7% decrease from one year ago. Soldotna's 67 permits were 21.5% of the KPB total, and was 9.5% less than last year. Seward, with 54 permits, gained 8.0% over last year while Seldovia issued 4 permits, down 66.7% from last year. (See detail on page 31.)

By Type, Volume. New residential activity declined 9.6%, to 94, with ten fewer permits than last year's 104 permits. Ninety-six residential alteration/addition permits were issued, 2.1% more than 2003. Commercial alteration/addition annual activity for 2004 decreased 16.7% as 80 permits were issued. New commercial activity was stable at 42 permits during both 2003 and 2004. (See detail on page 32.)

EMPLOYMENT

KPB's December 2004 labor force had 20,803 persons who were ready and willing to work, whether or not they were employed, the largest on record. The average monthly labor force for 2004 was 22,667 persons.

There were 2,465 persons listed as unemployed in the KPB during December, 393 fewer than 2003. The highest December unemployment total occurred during 1996 when 3,524 persons were ready and willing but unable to find employment. The 1995 total was not far behind, when 3,523 persons were unemployed. The 2004 average monthly unemployment was 2,456.

KPB's December unemployment rate reached 11.8%, two percentage points below last year. The average monthly unemployment rate for 2004 was 10.9%, down from 12.3% in 2003.

December 2004 employment in the KPB was 18,338 persons, an increase of 559 over 2003. The annual monthly average was 20,211, a new record high. (See detail on pages 37-41)

POPULATION

Population estimates for 2004 show the Kenai Peninsula population at 50,980 persons, an 0.8% loss for the year. Homer population was down 9.1% to 5,332 while Kachemak City lost 0.6% to a total of 475 persons. Soldotna also decreased, losing 5.6% to 3,767 residents. Kenai decreased 4.4% to 6,809 and Seldovia city lost 5.7% with 263 persons. Seward's population is down 7.5% to 2,540. Alaska's population, estimated at 648,818 for 2003, also marked a 0.1% increase for the year. (See page 42 for detail.)

KPB Sales

Sales tax records provide data useful for predicting economic trends and provide a basis for administrative decisions. Data collected are specific to the area collecting and reporting sales. By combining data from reporting communities, KPB trends can be determined. Routinely, three years or twelve quarters of information are revised each quarter. Prior to preparation of this publication, five years or twenty quarters have been updated. Sales data is provided by the KPB Finance Department, Sales Tax Division.

Homer sales data are significantly affected by the annexation of 4.58 square miles which increased the total area of Homer by over twenty-eight percent. The annexation became effective April 1, 2002.

KPB sales data include detail from Homer, Kenai, Seldovia, Seward, Soldotna and “KPB unincorporated” areas. “KPB unincorporated” indicates areas within the KPB but outside the boundaries of the five incorporated cities. It also includes Kachemak City, which does not impose a sales tax. The 2% KPB sales tax is included in the city rates listed below, with revenues dedicated to funding the KPB school district. The balance is tax imposed by each city with revenues being managed by that city after collection and disbursement by KPB staff.

The KPB does not provide an incentive for reporting non-taxable sales, resulting in incomplete gross sales data.

6.5%	6.0%	5.5%	5.0%	4.0%	2.0%
Seldovia (April - September)	Seward	Homer	Kenai Soldotna	Seldovia (October - March)	KPB Unincorporated

Gross and Taxable Sales data are received quarterly through Sales Tax Returns from businesses within the KPB. Sales that are exempt from sales tax assessments include:

- Sales outside the borough;
- Sales for resale;
- Sales to government agencies;
- Sales to tax exempt organizations; and
- Sales in excess of \$500.

Industry abbreviations used in sales data include the following:

- AFF - Agriculture, Forestry and Fisheries - includes fish buyers;
- Min - Mining - includes Oil & Gas extraction;
- Const - Construction;
- Manu - Manufacturing - includes Oil & Gas Manufacturing and Fish Processing;
- TCPU - Travel, Communications and Public Utilities;
- Whole - Wholesale Trade;
- Retail - Retail Trade;
- FIRE - Finance, Insurance and Real Estate;
- Service - Services;
- Govt - Public Administration, Education and Services.

KPB Sales

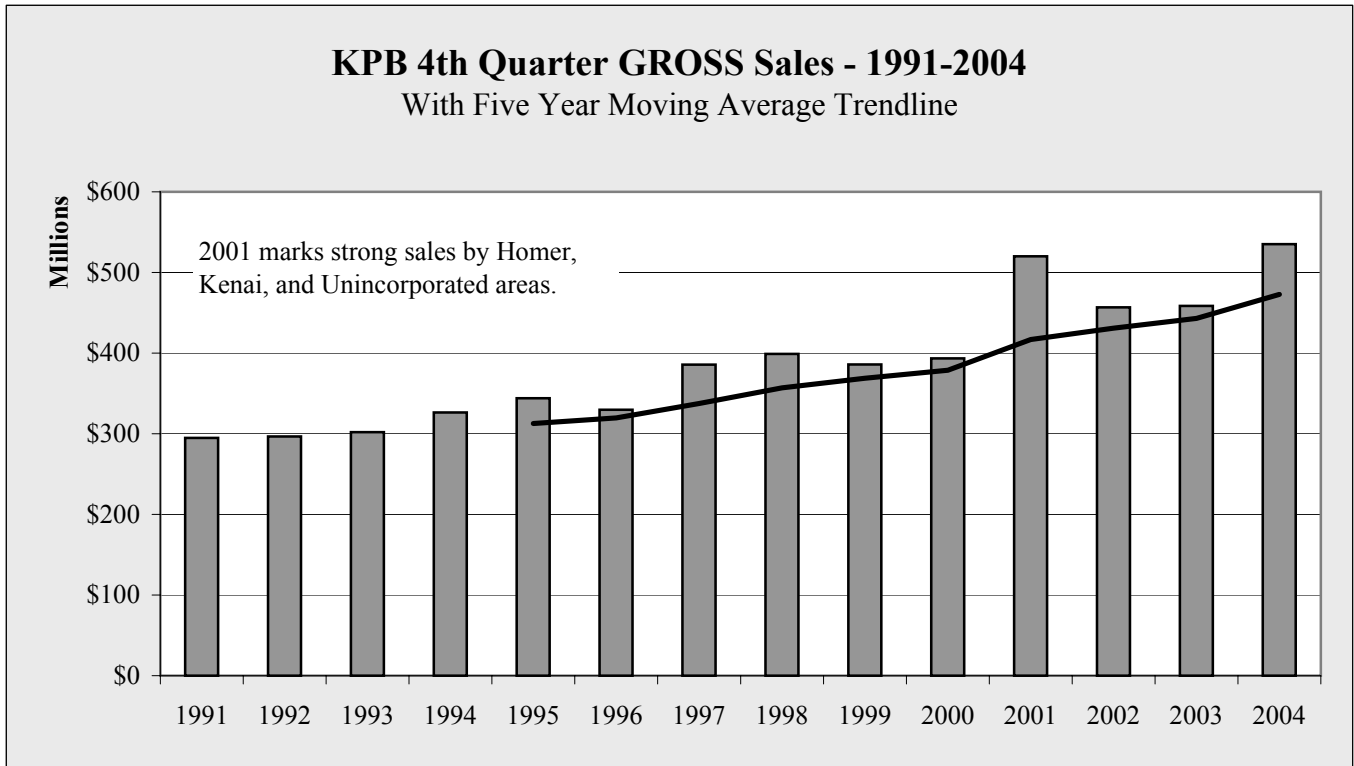

Chart 1.1

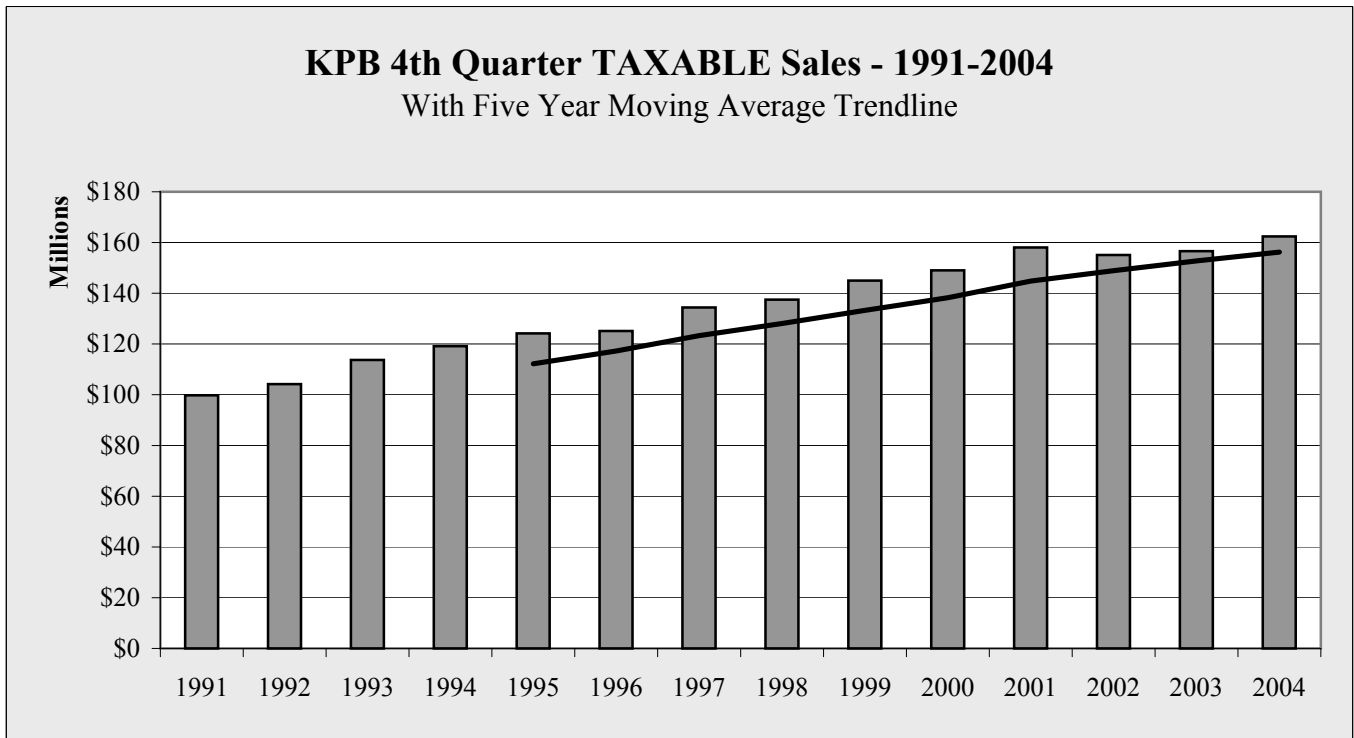

Chart 1.2

KPB Sales

KPB 4th Quarter GROSS Sales by INDUSTRY - 1998-2004 - in \$								
	1998	1999	2000	2001	2002	2003	2004	Annual Change
AFF	3,867,526	2,415,584	1,405,543	1,943,526	2,053,010	2,452,508	5,660,166	130.8%
Min	49,098,459	32,405,231	38,416,938	36,182,443	22,681,068	31,850,932	52,804,226	65.8%
Const	55,365,902	49,785,788	54,240,900	63,701,470	64,284,416	65,288,193	97,853,217	49.9%
Manu	34,831,029	40,626,472	24,516,398	117,472,843	78,273,315	60,389,787	31,334,632	-48.1%
TCPU	39,121,549	43,566,654	39,200,578	43,554,290	37,995,516	37,493,929	50,955,584	35.9%
Whole	35,312,940	37,307,418	37,534,503	40,763,366	47,409,885	46,583,505	55,086,960	18.3%
Retail	130,577,545	130,220,798	142,279,919	155,253,972	145,402,841	149,048,229	158,650,071	6.4%
FIRE	12,326,209	10,842,841	12,515,746	13,344,882	12,545,429	14,956,621	20,509,456	37.1%
Service	38,492,406	38,778,926	43,407,447	47,839,798	46,076,026	50,501,648	62,323,056	23.4%
Govt	2,804	3,649	2,247	1,200	3,730	8,789	3,737	-57.5%
Total	432,932,104	401,490,353	393,520,219	520,057,790	456,725,236	458,574,141	535,181,105	16.7%
Annual Change		-7.3%	-2.0%	32.2%	-12.2%	0.4%	16.7%	

Table 1.1

KPB 4th Quarter GROSS Sales Ten Year Change by INDUSTRY - 1994-2004 - in \$				
			10 Year Change	
	1994	2004	Percentage	Numerical
AFF	7,003,048	5,660,166	-19.2%	-1,342,882
Min	30,811,311	52,804,226	71.4%	21,992,915
Const	42,286,806	97,853,217	131.4%	55,566,411
Manu	26,973,074	31,334,632	16.2%	4,361,558
TCPU	52,498,250	50,955,584	-2.9%	-1,542,666
Whole	27,357,878	55,086,960	101.4%	27,729,082
Retail	97,304,436	158,650,071	63.0%	61,345,635
FIRE	12,757,531	20,509,456	60.8%	7,751,925
Service	29,358,555	62,323,056	112.3%	32,964,501
Govt	2,739	3,737	36.4%	998
Total	349,899,665	535,181,105	53.0%	185,281,440

Table 1.2

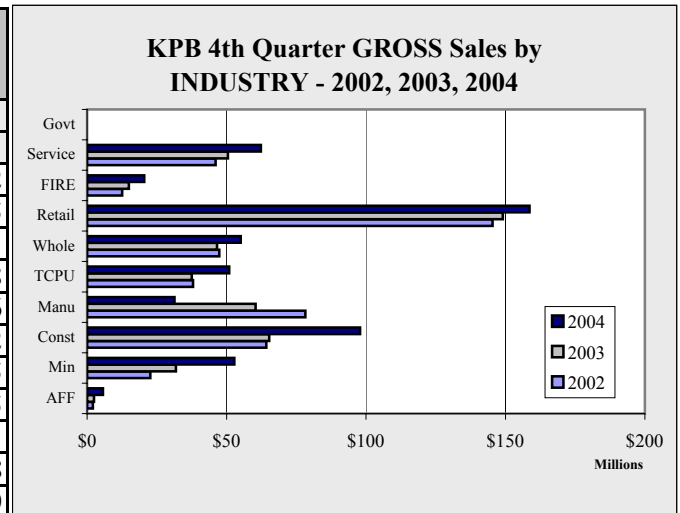

Chart 1.3

KPB 4th Quarter GROSS Sales One Year Change by INDUSTRY - 2003-2004 - in \$				
			1 Year Change	
	2003	2004	Percentage	Numerical
AFF	2,452,508	5,660,166	130.8%	3,207,658
Min	31,850,932	52,804,226	65.8%	20,953,294
Const	65,288,193	97,853,217	49.9%	32,565,024
Manu	60,389,787	31,334,632	-48.1%	-29,055,155
TCPU	37,493,929	50,955,584	35.9%	13,461,655
Whole	46,583,505	55,086,960	18.3%	8,503,455
Retail	149,048,229	158,650,071	6.4%	9,601,842
FIRE	14,956,621	20,509,456	37.1%	5,552,835
Service	50,501,648	62,323,056	23.4%	11,821,408
Govt	8,789	3,737	-57.5%	-5,052
Total	458,574,141	535,181,105	16.7%	76,606,964

Table 1.3

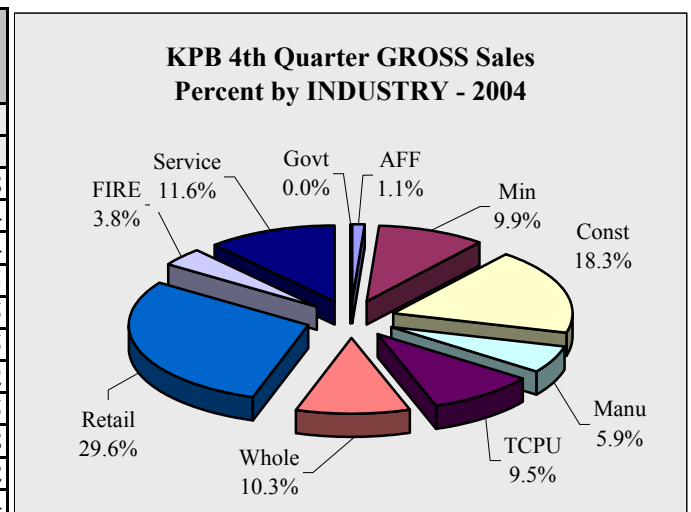

Chart 1.4

KPB Sales

KPB 4th Quarter TAXABLE Sales by INDUSTRY - 1998-2004 - in \$								
	1998	1999	2000	2001	2002	2003	2004	Annual Change
AFF	755,627	720,599	858,593	822,040	840,876	972,884	957,803	-1.6%
Min	1,043,377	1,097,822	1,260,660	1,609,419	1,331,469	1,167,280	1,460,913	25.2%
Const	2,606,387	2,564,023	2,392,337	2,557,326	2,705,826	2,772,568	2,841,221	2.5%
Manu	1,840,127	1,914,558	1,986,299	1,768,274	1,800,030	1,860,180	1,744,372	-6.2%
TCPU	17,906,374	21,604,603	18,965,148	20,652,944	19,789,923	19,683,518	20,771,617	5.5%
Whole	4,426,560	5,147,173	5,136,269	5,558,317	4,911,676	5,753,910	5,561,924	-3.3%
Retail	84,978,995	88,028,006	91,997,444	98,201,066	96,708,075	97,803,925	101,882,441	4.2%
FIRE	4,464,490	4,277,556	5,298,517	5,870,731	5,636,554	5,008,242	5,721,949	14.3%
Service	19,482,050	19,633,084	21,136,212	20,991,714	21,364,400	21,594,634	21,431,737	-0.8%
Govt	2,797	3,649	2,247	1,200	3,730	8,789	3,737	-57.5%
Total	137,506,784	144,991,073	149,033,726	158,033,031	155,092,559	156,625,930	162,377,714	3.7%
Annual Change		5.4%	2.8%	6.0%	-1.9%	1.0%	3.7%	

Table 1.4

KPB 4th Quarter TAXABLE Sales Ten Year Change by INDUSTRY - 1994-2004 - in \$				
			10 Year Change	
	1994	2004	Percentage	Numerical
AFF	561,455	957,803	70.6%	396,348
Min	1,287,125	1,460,913	13.5%	173,788
Const	2,213,354	2,841,221	28.4%	627,867
Manu	1,577,405	1,744,372	10.6%	166,967
TCPU	15,958,327	20,771,617	30.2%	4,813,290
Whole	4,639,137	5,561,924	19.9%	922,787
Retail	71,702,320	101,882,441	42.1%	30,180,121
FIRE	4,458,741	5,721,949	28.3%	1,263,208
Service	16,755,796	21,431,737	27.9%	4,675,941
Govt	2,739	3,737	36.4%	998
Total	119,156,399	162,377,714	36.3%	43,221,315

Table 1.5

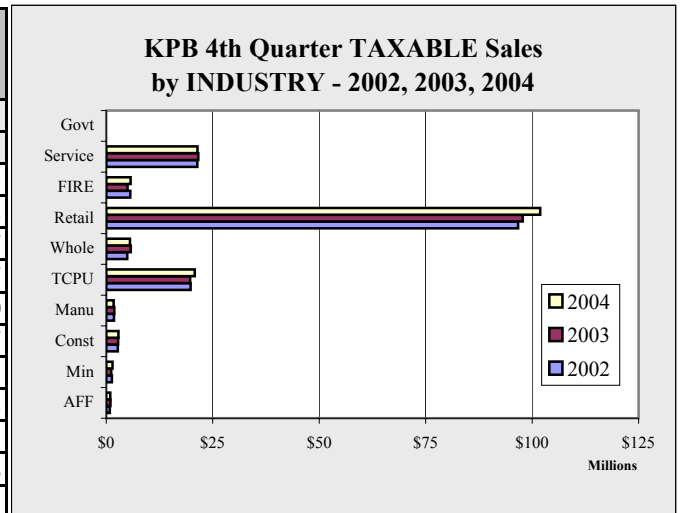

Chart 1.5

KPB 4th Quarter TAXABLE Sales One Year Change by INDUSTRY - 2003-2004 - in \$				
			1 Year Change	
	2003	2004	Percentage	Numerical
AFF	972,884	957,803	-1.6%	-15,081
Min	1,167,280	1,460,913	25.2%	293,633
Const	2,772,568	2,841,221	2.5%	68,653
Manu	1,860,180	1,744,372	-6.2%	-115,808
TCPU	19,683,518	20,771,617	5.5%	1,088,099
Whole	5,753,910	5,561,924	-3.3%	-191,986
Retail	97,803,925	101,882,441	4.2%	4,078,516
FIRE	5,008,242	5,721,949	14.3%	713,707
Service	21,594,634	21,431,737	-0.8%	-162,897
Govt	8,789	3,737	-57.5%	-5,052
Total	156,625,930	162,377,714	3.7%	5,751,784

Table 1.6

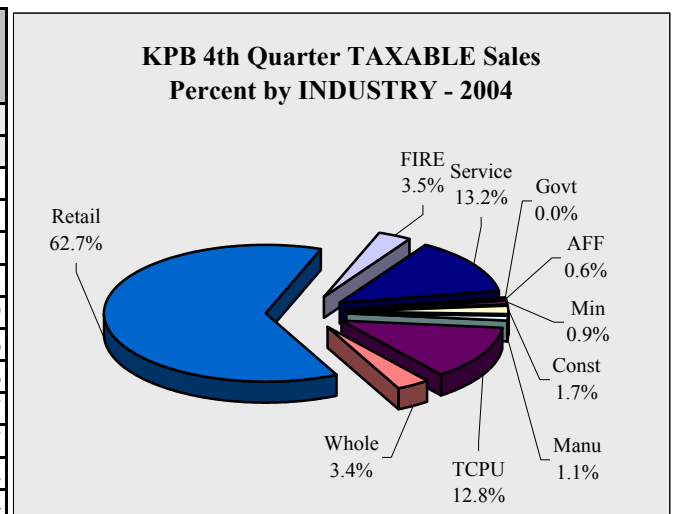

Chart 1.6

KPB Sales

KPB 4th Quarter GROSS Sales by AREA - 1998-2004 - in \$								
	1998	1999	2000	2001	2002	2003	2004	Annual Change
Homer	46,799,617	44,064,518	48,229,307	54,547,098	60,568,508	60,184,407	72,065,062	19.7%
Kenai	67,609,090	67,950,329	72,408,759	76,422,702	68,618,104	72,545,810	72,566,317	0.03%
Seldovia	872,701	841,338	896,097	919,801	956,936	1,949,309	3,129,207	60.5%
Seward	24,026,995	20,247,664	27,790,366	20,503,354	22,306,088	27,334,414	38,561,236	41.1%
Soldotna	66,596,151	70,579,609	72,007,899	77,603,011	80,180,782	82,155,118	92,685,505	12.8%
KPB Unincorporated	193,091,815	182,269,903	172,187,791	290,061,824	224,094,818	214,405,083	256,173,778	19.5%
Total	398,996,369	385,953,361	393,520,219	520,057,790	456,725,236	458,574,141	535,181,105	16.7%
Annual Change		-3.3%	2.0%	32.2%	-12.2%	0.4%	16.7%	

Table 1.7

KPB 4th Quarter GROSS Sales Ten Year Change by AREA - 1994-2004 - in \$				
			10 Year Change	
	1994	2004	Percentage	Numerical
Homer	38,217,421	72,065,062	88.6%	33,847,641
Kenai	56,477,738	72,566,317	28.5%	16,088,579
Seldovia	1,350,093	3,129,207	131.8%	1,779,114
Seward	18,605,214	38,561,236	107.3%	19,956,022
Soldotna	51,364,458	92,685,505	80.4%	41,321,047
KPB Unincorporated	160,338,704	256,173,778	59.8%	95,835,074
Total	326,353,628	535,181,105	64.0%	208,827,477

Table 1.8

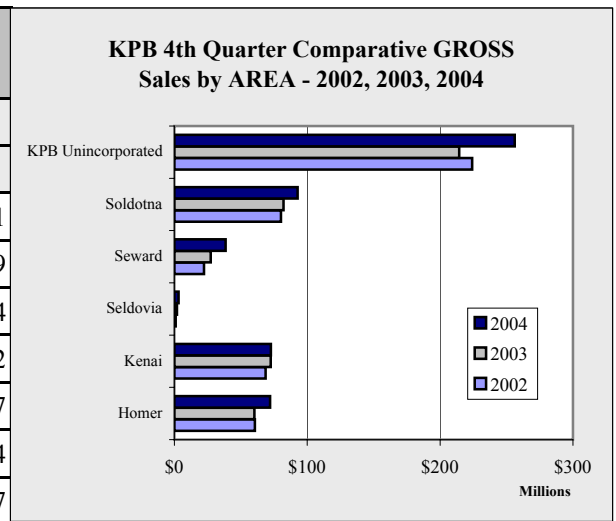

Chart 1.7

KPB 4th Quarter GROSS Sales One Year Change by AREA - 2003-2004 - in \$				
			1 Year Change	
	2003	2004	Percentage	Numerical
Homer	60,184,407	72,065,062	19.7%	11,880,655
Kenai	72,545,810	72,566,317	0.03%	20,507
Seldovia	1,949,309	3,129,207	60.5%	1,179,898
Seward	27,334,414	38,561,236	41.1%	11,226,822
Soldotna	82,155,118	92,685,505	12.8%	10,530,387
KPB Unincorporated	214,405,083	256,173,778	19.5%	41,768,695
Total	458,574,141	535,181,105	16.7%	76,606,964

Table 1.9

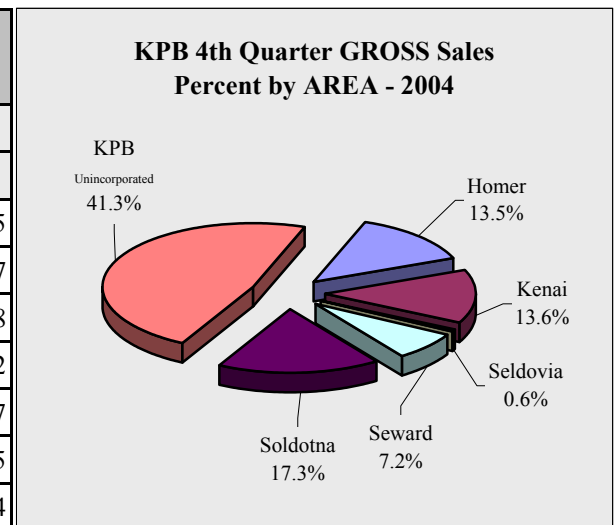

Chart 1.8

KPB Sales

KPB 4th Quarter TAXABLE Sales by AREA - 1998-2004 - in \$								
	1998	1999	2000	2001	2002	2003	2004	Annual Change
Homer	19,552,917	20,323,983	21,387,173	21,780,156	25,052,414	27,071,736	27,272,024	0.7%
Kenai	31,957,166	33,717,815	34,062,345	36,003,199	34,988,723	29,088,532	32,782,140	12.7%
Seldovia	616,657	599,222	589,667	612,166	607,946	674,689	689,034	2.1%
Seward	9,772,599	10,557,267	10,544,695	10,007,501	10,033,118	10,296,934	10,274,470	-0.2%
Soldotna	36,834,109	38,807,035	40,481,909	42,868,739	42,248,703	46,558,340	46,724,370	0.4%
KPB Unincorporated	38,773,336	40,985,751	41,967,937	46,761,270	42,161,655	42,935,699	44,635,676	4.0%
Total	137,506,784	144,991,073	149,033,726	158,033,031	155,092,559	156,625,930	162,377,714	3.7%
Annual Change		5.4%	2.8%	6.0%	-1.9%	1.0%	3.7%	

Table 1.10

KPB 4th Quarter TAXABLE Sales Ten Year Change by AREA - 1994-2004 - in \$				
	1994	2004	10 Year Change	
			Percentage	Numerical
Homer	16,734,643	27,272,024	63.0%	10,537,381
Kenai	32,086,350	32,782,140	2.2%	695,790
Seldovia	593,416	689,034	16.1%	95,618
Seward	8,095,448	10,274,470	26.9%	2,179,022
Soldotna	24,082,915	46,724,370	94.0%	22,641,455
KPB Unincorporated	32,780,220	44,635,676	36.2%	11,855,456
Total	113,695,439	162,377,714	42.8%	48,682,275

Table 1.11

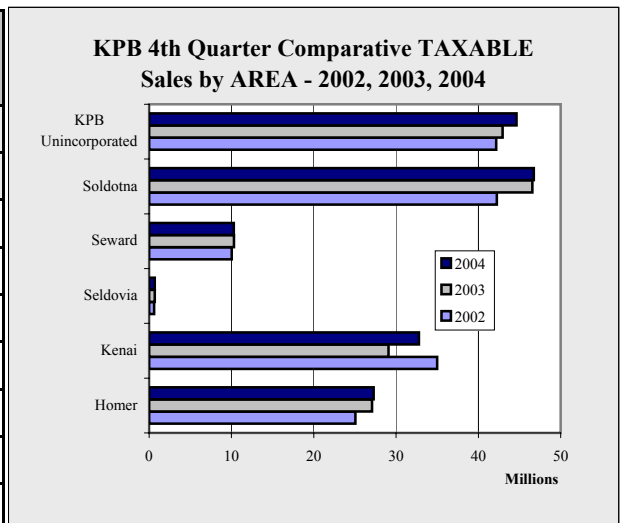

Chart 1.9

KPB 4th Quarter TAXABLE Sales One Year Change by AREA - 2003-2004 - in \$				
	2003	2004	1 Year Change	
			Percentage	Numerical
Homer	27,071,736	27,272,024	0.7%	200,288
Kenai	29,088,532	32,782,140	12.7%	3,693,608
Seldovia	674,689	689,034	2.1%	14,345
Seward	10,296,934	10,274,470	-0.2%	-22,464
Soldotna	46,558,340	46,724,370	0.4%	166,030
KPB Unincorporated	42,935,699	44,635,676	4.0%	1,699,977
Total	156,625,930	162,377,714	3.7%	5,751,784

Table 1.12

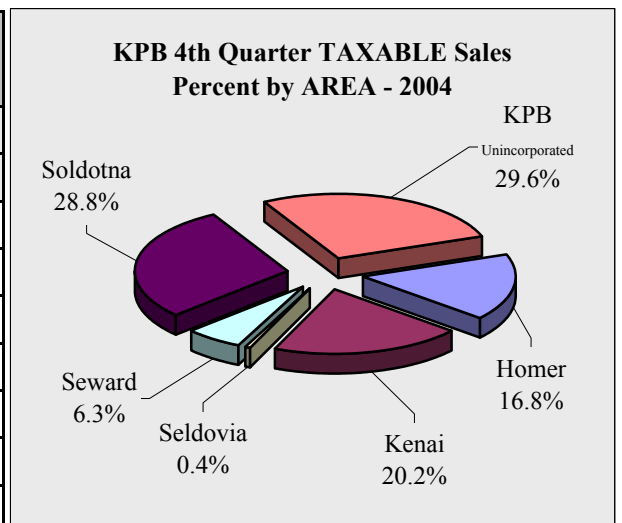

Chart 1.10

KPB Sales

KPB Annual GROSS Sales by INDUSTRY - 1998-2004 - in \$								
	1998	1999	2000	2001	2002	2003	2004	Annual Change
AFF	30,373,442	32,347,943	24,816,872	17,584,763	16,750,059	22,009,310	27,600,197	25.4%
Min	190,689,442	115,241,075	121,868,065	126,250,792	113,521,181	106,561,739	163,704,724	53.6%
Const	187,102,648	166,008,223	185,994,582	241,706,588	229,399,098	257,933,387	235,868,805	-8.6%
Manu	147,360,433	165,066,528	117,856,947	287,725,053	201,047,383	199,442,339	170,189,095	-14.7%
TCPU	159,766,641	169,321,042	156,272,089	173,246,581	172,554,610	158,372,166	180,587,427	14.0%
Whole	149,117,372	155,121,630	171,235,874	177,036,125	188,223,387	194,212,922	202,865,950	4.5%
Retail	547,202,550	545,752,691	580,370,933	633,597,773	625,008,358	644,695,462	697,393,919	8.2%
FIRE	50,782,517	51,186,806	50,390,903	54,153,772	54,924,793	58,011,247	65,169,307	12.3%
Service	211,144,805	220,251,298	235,820,173	256,185,223	276,510,185	278,130,348	316,292,402	13.7%
Govt	26,751	28,814	17,350	20,316	22,579	41,980	35,105	-16.4%
Total	1,673,566,601	1,620,326,050	1,644,643,788	1,967,506,986	1,877,961,633	1,919,410,900	2,059,706,931	7.3%
Annual Change		-3.2%	1.5%	19.6%	-4.6%	2.2%	7.3%	

Table 1.13

KPB Annual GROSS Sales Ten Year Change by INDUSTRY - 1994-2004 - in \$				
	10 Year Change			
	1994	2004	Percentage	Numerical
AFF	55,520,292	27,600,197	-50.3%	-27,920,095
Min	124,428,885	163,704,724	31.6%	39,275,839
Const	144,672,165	235,868,805	63.0%	91,196,640
Manu	125,684,092	170,189,095	35.4%	44,505,003
TCPU	216,882,266	180,587,427	-16.7%	-36,294,839
Whole	88,960,238	202,865,950	128.0%	113,905,712
Retail	406,692,795	697,393,919	71.5%	290,701,124
FIRE	55,375,125	65,169,307	17.7%	9,794,182
Service	165,995,597	316,292,402	90.5%	150,296,805
Govt	10,251	35,105	242.5%	24,854
Total	1,384,221,706	2,059,706,931	48.8%	675,485,225

Table 1.14

KPB Annual GROSS Sales One Year Change by INDUSTRY - 2003-2004 - in \$				
	1 Year Change			
	2003	2004	Percentage	Numerical
AFF	22,009,310	27,600,197	25.4%	5,590,887
Min	106,561,739	163,704,724	53.6%	57,142,985
Const	257,933,387	235,868,805	-8.6%	-22,064,582
Manu	199,442,339	170,189,095	-14.7%	-29,253,244
TCPU	158,372,166	180,587,427	14.0%	22,215,261
Whole	194,212,922	202,865,950	4.5%	8,653,028
Retail	644,695,462	697,393,919	8.2%	52,698,457
FIRE	58,011,247	65,169,307	12.3%	7,158,060
Service	278,130,348	316,292,402	13.7%	38,162,054
Govt	41,980	35,105	-16.4%	-6,875
Total	1,919,410,900	2,059,706,931	7.3%	140,296,031

Table 1.15

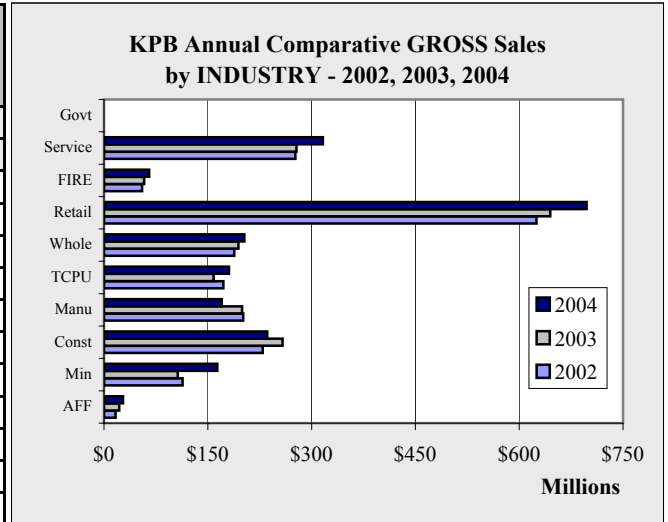

Chart 1.11

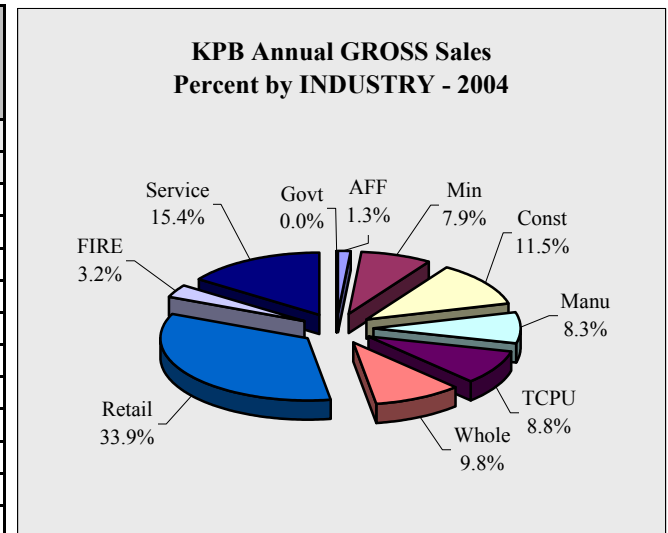

Chart 1.12

KPB Sales

KPB Annual TAXABLE Sales by INDUSTRY - 1998-2004 - in \$								
	1998	1999	2000	2001	2002	2003	2004	Annual Change
AFF	3,458,989	3,539,802	4,148,862	4,391,790	4,461,252	5,010,961	5,494,205	9.6%
Min	5,202,698	3,828,650	4,613,878	5,863,223	5,848,904	4,885,262	5,499,300	12.6%
Const	9,821,330	9,921,434	9,658,671	10,002,648	10,709,485	11,272,492	11,281,948	0.1%
Manu	9,578,020	9,251,298	9,792,611	9,654,663	9,616,559	9,239,486	9,837,983	6.5%
TCPU	72,108,745	79,282,344	77,420,153	79,415,747	83,947,088	81,373,510	82,312,722	1.2%
Whole	18,357,305	19,290,256	21,493,691	22,282,063	21,690,782	24,139,455	25,574,064	5.9%
Retail	353,131,302	367,123,730	383,777,809	411,721,005	419,549,532	429,266,128	460,484,927	7.3%
FIRE	18,576,711	18,862,816	20,702,551	23,486,072	24,084,827	22,751,829	22,947,825	0.9%
Service	122,225,757	129,434,976	135,510,623	139,066,219	144,301,953	144,717,518	154,138,882	6.5%
Govt	26,744	28,814	17,350	20,316	22,579	41,980	35,040	-16.5%
Total	612,487,601	640,564,120	667,136,199	705,903,746	724,232,961	732,698,621	777,606,896	6.1%
Annual Change		4.6%	4.1%	5.8%	2.6%	1.2%	6.1%	

Table 1.16

KPB Annual TAXABLE Sales Ten Year Change by INDUSTRY - 1994-2004 - in \$				
	1994	2004	10 Year Change	
			Percentage	Numerical
AFF	3,454,687	5,494,205	59.0%	2,039,518
Min	6,132,287	5,499,300	-10.3%	-632,987
Const	8,077,694	11,281,948	39.7%	3,204,254
Manu	7,808,695	9,837,983	26.0%	2,029,288
TCPU	64,017,267	82,312,722	28.6%	18,295,455
Whole	19,542,465	25,574,064	30.9%	6,031,599
Retail	299,416,591	460,484,927	53.8%	161,068,336
FIRE	18,378,264	22,947,825	24.9%	4,569,561
Service	100,262,803	154,138,882	53.7%	53,876,079
Govt	10,251	35,040	241.8%	24,789
Total	527,101,004	777,606,896	47.5%	250,505,892

Table 1.17

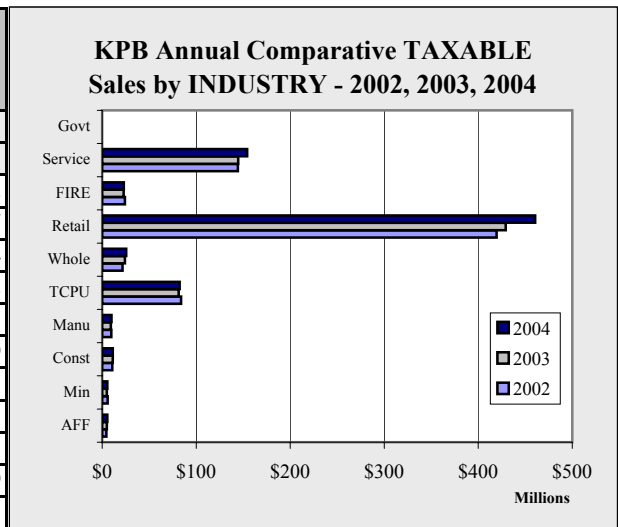

Chart 1.13

KPB Annual TAXABLE Sales One Year Change by INDUSTRY - 2003-2004 - in \$				
	2003	2004	1 Year Change	
			Percentage	Numerical
AFF	5,010,961	5,494,205	9.6%	483,244
Min	4,885,262	5,499,300	12.6%	614,038
Const	11,272,492	11,281,948	0.1%	9,456
Manu	9,239,486	9,837,983	6.5%	598,497
TCPU	81,373,510	82,312,722	1.2%	939,212
Whole	24,139,455	25,574,064	5.9%	1,434,609
Retail	429,266,128	460,484,927	7.3%	31,218,799
FIRE	22,751,829	22,947,825	0.9%	195,996
Service	144,717,518	154,138,882	6.5%	9,421,364
Govt	41,980	35,040	-16.5%	-6,940
Total	732,698,621	777,606,896	6.1%	44,908,275

Table 1.18

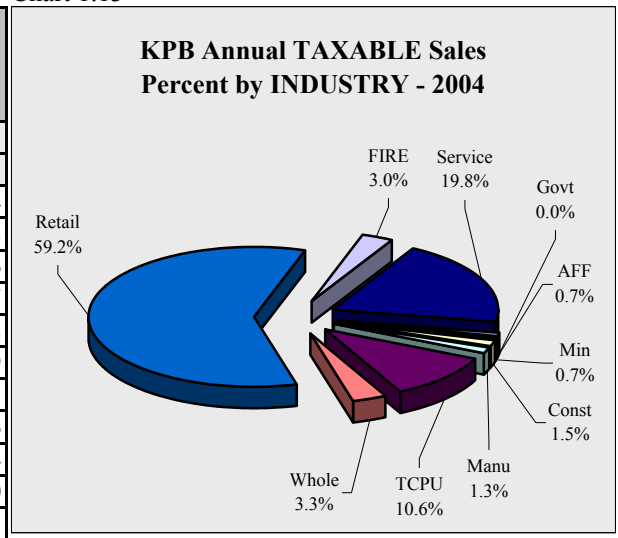

Chart 1.14

KPB Sales

KPB Annual GROSS Sales by AREA - 1998-2004 - in \$								
	1998	1999	2000	2001	2002	2003	2004	Annual Change
Homer	212,442,617	203,842,475	215,981,724	229,703,507	263,195,800	273,423,089	284,212,220	3.9%
Kenai	280,079,940	270,746,118	283,682,464	310,426,425	279,745,403	283,340,242	308,173,470	8.8%
Seldovia	4,723,739	4,844,770	5,267,325	5,249,471	4,817,877	7,259,554	9,662,317	33.1%
Seward	132,506,248	130,155,521	142,152,279	148,360,553	142,367,126	156,959,598	167,348,329	6.6%
Soldotna	250,793,664	277,588,737	289,255,311	309,118,231	325,899,019	337,772,973	360,824,580	6.8%
KPB Unincorporated	793,020,393	733,148,429	708,304,685	964,648,799	861,936,408	860,655,444	929,486,015	8.0%
Total	1,673,566,601	1,620,326,050	1,644,643,788	1,967,506,986	1,877,961,633	1,919,410,900	2,059,706,931	7.3%
Annual Change		-3.2%	1.5%	19.6%	-4.6%	2.2%	7.3%	

Table 1.19

KPB Annual GROSS Sales Ten Year Change by AREA - 1994-2004 - in \$				
	1994	2004	10 Year Change	
			Percentage	Numerical
Homer	171,092,369	284,212,220	66.1%	113,119,851
Kenai	249,216,590	308,173,470	23.7%	58,956,880
Seldovia	5,275,307	9,662,317	83.2%	4,387,010
Seward	99,875,014	167,348,329	67.6%	67,473,315
Soldotna	194,609,544	360,824,580	85.4%	166,215,036
KPB Unincorporated	664,152,882	929,486,015	40.0%	265,333,133
Total	1,384,221,706	2,059,706,931	48.8%	675,485,225

Table 1.20

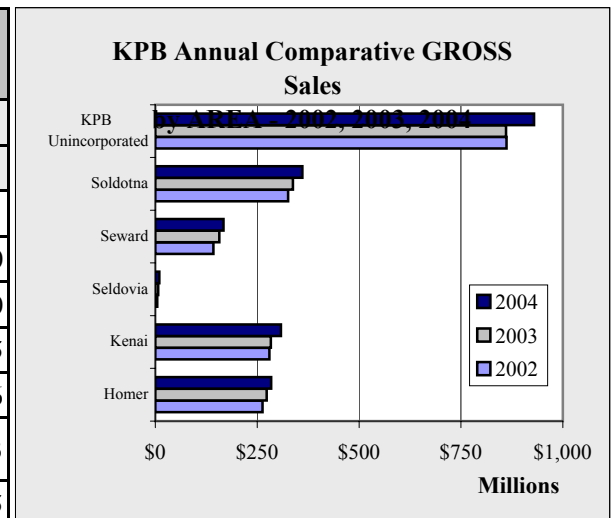

Chart 1.15

KPB Annual GROSS Sales One Year Change by AREA - 2003-2004 - in \$				
	2003	2004	1 Year Change	
			Percentage	Numerical
Homer	273,423,089	284,212,220	3.9%	10,789,131
Kenai	283,340,242	308,173,470	8.8%	24,833,228
Seldovia	7,259,554	9,662,317	33.1%	2,402,763
Seward	156,959,598	167,348,329	6.6%	10,388,731
Soldotna	337,772,973	360,824,580	6.8%	23,051,607
KPB Unincorporated	860,655,444	929,486,015	8.0%	68,830,571
Total	1,919,410,900	2,059,706,931	7.3%	140,296,031

Table 1.21

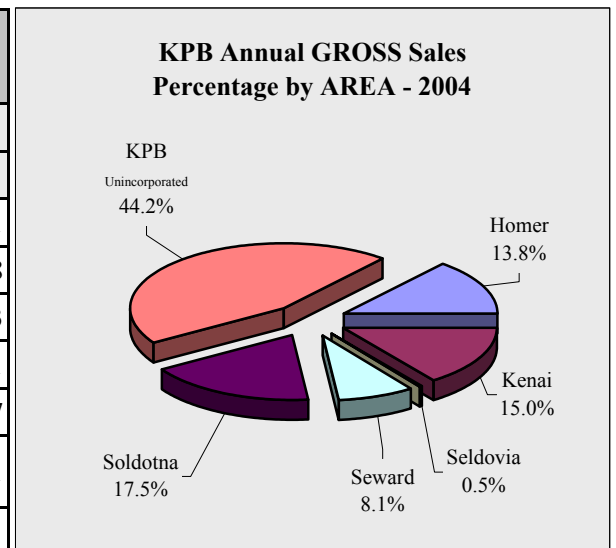

Chart 1.16

KPB Sales

KPB Annual TAXABLE Sales by AREA - 1998-2004 - in \$								
	1998	1999	2000	2001	2002	2003	2004	Annual Change
Homer	94,441,342	98,148,738	103,190,116	107,311,539	121,268,118	131,623,225	139,700,742	6.1%
Kenai	120,030,707	124,367,091	127,766,126	137,043,924	136,769,610	121,407,461	138,869,827	14.4%
Seldovia	3,398,293	3,229,249	3,418,123	3,359,279	3,272,389	3,376,944	3,377,487	0.02%
Seward	67,278,264	71,472,199	73,983,426	74,225,591	75,598,696	76,375,738	79,639,924	4.3%
Soldotna	147,789,661	155,952,764	159,436,128	172,418,438	176,977,868	190,616,882	199,135,668	4.5%
KPB Unincorporated	179,549,334	187,394,079	199,342,280	211,544,975	210,346,280	209,298,371	216,883,248	3.6%
Total	612,487,601	640,564,120	667,136,199	705,903,746	724,232,961	732,698,621	777,606,896	6.1%
Annual Change		4.6%	4.1%	5.8%	2.6%	1.2%	6.1%	

Table 1.22

KPB Annual TAXABLE Sales Ten Year Change by AREA - 1994-2004 - in \$				
	10 Year Change			
	1994	2004	Percentage	Numerical
Homer	84,045,458	139,700,742	66.2%	55,655,284
Kenai	114,402,035	138,869,827	21.4%	24,467,792
Seldovia	3,117,185	3,377,487	8.4%	260,302
Seward	53,259,177	79,639,924	49.5%	26,380,747
Soldotna	119,702,481	199,135,668	66.4%	79,433,187
KPB Unincorporated	152,574,668	216,883,248	42.1%	64,308,580
Total	527,101,004	777,606,896	47.5%	250,505,892

Table 1.23

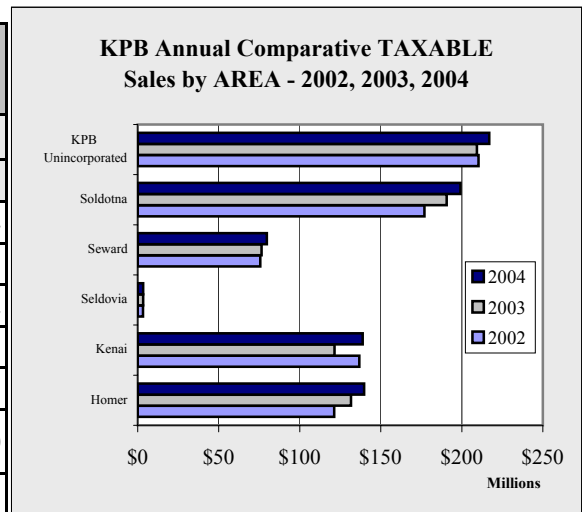

Chart 1.17

KPB Annual TAXABLE Sales One Year Change by AREA - 2003-2004 - in \$				
	1 Year Change			
	2003	2004	Percentage	Numerical
Homer	131,623,225	139,700,742	6.1%	8,077,517
Kenai	121,407,461	138,869,827	14.4%	17,462,366
Seldovia	3,376,944	3,377,487	0.02%	543
Seward	76,375,738	79,639,924	4.3%	3,264,186
Soldotna	190,616,882	199,135,668	4.5%	8,518,786
KPB Unincorporated	209,298,371	216,883,248	3.6%	7,584,877
Total	732,698,621	777,606,896	6.1%	44,908,275

Table 1.24

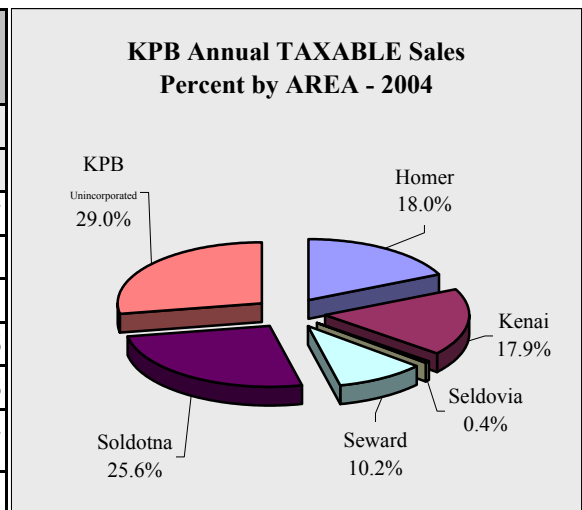

Chart 1.18

KPB Sales

KPB Annual GROSS Sales by INDUSTRY by Quarter - 2001-2004 - in \$					
	1st Quarter	2nd Quarter	3rd Quarter	4th Quarter	Total
2001					
AFF	1,582,046	2,803,392	11,255,799	1,943,526	17,584,763
Min	28,223,945	26,110,361	35,734,043	36,182,443	126,250,792
Const	39,654,662	51,568,925	86,781,531	63,701,470	241,706,588
Manu	48,476,583	56,672,953	65,102,674	117,472,843	287,725,053
TCPU	38,441,450	40,127,980	51,122,861	43,554,290	173,246,581
Whole	35,974,922	44,103,011	56,194,826	40,763,366	177,036,125
Retail	116,491,269	166,794,245	195,058,287	155,253,972	633,597,773
FIRE	10,915,997	13,531,404	16,361,489	13,344,882	54,153,772
Service	36,278,453	70,429,963	101,637,009	47,839,798	256,185,223
Govt	6,507	5,238	7,371	1,200	20,316
Total	356,045,834	472,147,472	619,255,890	520,057,790	1,967,506,986
2002					
AFF	2,004,841	2,856,503	9,835,705	2,053,010	16,750,059
Min	34,662,385	29,861,507	26,316,221	22,681,068	113,521,181
Const	43,149,133	49,852,546	72,113,003	64,284,416	229,399,098
Manu	21,341,761	44,663,448	56,768,859	78,273,315	201,047,383
TCPU	40,723,392	42,378,179	51,457,523	37,995,516	172,554,610
Whole	37,128,746	46,538,996	57,145,760	47,409,885	188,223,387
Retail	115,899,097	165,285,986	198,420,434	145,402,841	625,008,358
FIRE	12,389,238	14,756,677	15,233,449	12,545,429	54,924,793
Service	43,234,458	77,421,202	109,778,499	46,076,026	276,510,185
Govt	6,700	7,859	4,290	3,730	22,579
Total	350,539,751	473,622,903	597,073,743	456,725,236	1,877,961,633
2003					
AFF	2,019,939	4,045,723	13,491,140	2,452,508	22,009,310
Min	19,260,142	25,083,685	30,366,980	31,850,932	106,561,739
Const	42,996,665	67,754,953	81,893,576	65,288,193	257,933,387
Manu	38,576,448	34,259,747	66,216,357	60,389,787	199,442,339
TCPU	38,217,073	38,841,966	43,819,198	37,493,929	158,372,166
Whole	35,918,425	50,841,751	60,869,241	46,583,505	194,212,922
Retail	123,118,509	170,711,911	201,816,813	149,048,229	644,695,462
FIRE	11,704,586	15,275,186	16,074,854	14,956,621	58,011,247
Service	41,543,461	77,620,889	108,464,350	50,501,648	278,130,348
Govt	12,319	8,680	12,192	8,789	41,980
Total	353,367,567	484,444,491	623,024,701	458,574,141	1,919,410,900
2004					
AFF	2,338,292	3,909,386	15,692,353	5,660,166	27,600,197
Min	39,801,394	32,098,347	39,000,757	52,804,226	163,704,724
Const	28,642,511	42,389,136	66,983,941	97,853,217	235,868,805
Manu	26,107,055	15,540,229	97,207,179	31,334,632	170,189,095
TCPU	38,959,049	35,425,609	55,247,185	50,955,584	180,587,427
Whole	41,782,771	50,630,515	55,365,704	55,086,960	202,865,950
Retail	126,830,999	187,680,196	224,232,653	158,650,071	697,393,919
FIRE	13,306,235	14,402,330	16,951,286	20,509,456	65,169,307
Service	48,428,811	86,026,435	119,514,100	62,323,056	316,292,402
Govt	13,663	8,521	9,184	3,737	35,105
Total	366,210,780	468,110,704	690,204,342	535,181,105	2,059,706,931

Table 1.25

KPB Sales

KPB Annual TAXABLE Sales by INDUSTRY by Quarter - 2001-2004 - in \$					
	1st Quarter	2nd Quarter	3rd Quarter	4th Quarter	Total
2001					
AFF	728,231	1,401,861	1,439,658	822,040	4,391,790
Min	1,227,851	1,349,445	1,676,508	1,609,419	5,863,223
Const	1,866,887	2,526,383	3,052,052	2,557,326	10,002,648
Manu	1,497,558	2,885,132	3,503,699	1,768,274	9,654,663
TCPU	19,320,190	19,064,716	20,377,897	20,652,944	79,415,747
Whole	4,606,145	5,794,250	6,323,351	5,558,317	22,282,063
Retail	73,704,826	108,655,727	131,159,386	98,201,066	411,721,005
FIRE	4,989,928	5,949,812	6,675,601	5,870,731	23,486,072
Service	17,911,006	40,842,035	59,321,464	20,991,714	139,066,219
Govt	6,507	5,238	7,371	1,200	20,316
Total	125,859,129	188,474,599	233,536,987	158,033,031	705,903,746
2002					
AFF	796,380	1,423,988	1,400,008	840,876	4,461,252
Min	1,482,601	1,484,251	1,550,583	1,331,469	5,848,904
Const	2,037,148	2,677,823	3,288,688	2,705,826	10,709,485
Manu	1,307,744	2,791,765	3,717,020	1,800,030	9,616,559
TCPU	21,573,935	21,477,202	21,106,028	19,789,923	83,947,088
Whole	4,783,261	5,679,123	6,316,722	4,911,676	21,690,782
Retail	76,421,463	109,883,510	136,536,484	96,708,075	419,549,532
FIRE	5,453,086	6,078,006	6,917,181	5,636,554	24,084,827
Service	18,939,288	41,353,274	62,644,991	21,364,400	144,301,953
Govt	6,700	7,859	4,290	3,730	22,579
Total	132,801,606	192,856,801	243,481,995	155,092,559	724,232,961
2003					
AFF	763,045	1,577,278	1,697,754	972,884	5,010,961
Min	1,233,618	1,170,493	1,313,871	1,167,280	4,885,262
Const	2,055,383	3,124,868	3,319,673	2,772,568	11,272,492
Manu	1,438,887	2,607,213	3,333,206	1,860,180	9,239,486
TCPU	21,650,525	20,321,138	19,718,329	19,683,518	81,373,510
Whole	5,018,011	6,296,538	7,070,996	5,753,910	24,139,455
Retail	79,981,563	112,417,564	139,063,076	97,803,925	429,266,128
FIRE	5,309,694	5,975,269	6,458,624	5,008,242	22,751,829
Service	18,779,067	41,517,128	62,826,689	21,594,634	144,717,518
Govt	12,319	8,680	12,192	8,789	41,980
Total	136,242,112	195,016,169	244,814,410	156,625,930	732,698,621
2004					
AFF	886,643	1,672,857	1,976,902	957,803	5,494,205
Min	1,047,668	1,082,504	1,908,215	1,460,913	5,499,300
Const	2,217,009	2,933,623	3,290,095	2,841,221	11,281,948
Manu	1,512,130	2,737,701	3,843,780	1,744,372	9,837,983
TCPU	21,020,041	19,483,426	21,037,638	20,771,617	82,312,722
Whole	5,857,184	6,560,284	7,594,672	5,561,924	25,574,064
Retail	83,152,136	122,347,724	153,102,626	101,882,441	460,484,927
FIRE	4,893,580	5,714,570	6,617,726	5,721,949	22,947,825
Service	19,254,311	44,456,148	68,996,686	21,431,737	154,138,882
Govt	13,598	8,521	9,184	3,737	35,040
Total	139,854,300	206,997,358	268,377,524	162,377,714	777,606,896

Table 1.26

KPB Sales

KPB Annual GROSS Sales by AREA by Quarter - 1999-2004 - in \$					
	1st Qtr	2nd Qtr	3rd Qtr	4th Qtr	Total
1999					
Homer	39,553,648	53,871,188	66,353,121	44,064,518	203,842,475
Kenai	49,309,897	61,605,164	91,880,728	67,950,329	270,746,118
Seldovia	908,058	1,388,188	1,707,186	841,338	4,844,770
Seward	23,356,887	36,041,325	50,509,645	20,247,664	130,155,521
Soldotna	51,429,980	67,874,942	87,704,206	70,579,609	277,588,737
KPB Unincorporated	137,446,972	180,709,546	232,722,008	182,269,903	733,148,429
Total	302,005,442	401,490,353	530,876,894	385,953,361	1,620,326,050
2000					
Homer	38,455,167	59,287,582	70,009,668	48,229,307	215,981,724
Kenai	55,609,576	66,158,563	89,505,566	72,408,759	283,682,464
Seldovia	1,150,692	1,526,900	1,693,636	896,097	5,267,325
Seward	19,087,797	38,014,037	57,260,079	27,790,366	142,152,279
Soldotna	55,201,896	72,515,215	89,530,301	72,007,899	289,255,311
KPB Unincorporated	126,664,981	183,977,517	225,474,396	172,187,791	708,304,685
Total	296,170,109	421,479,814	533,473,646	393,520,219	1,644,643,788
2001					
Homer	40,844,978	56,857,475	77,453,956	54,547,098	229,703,507
Kenai	62,418,286	76,673,936	94,911,501	76,422,702	310,426,425
Seldovia	898,811	1,473,305	1,957,554	919,801	5,249,471
Seward	20,531,272	44,452,278	62,873,649	20,503,354	148,360,553
Soldotna	60,802,277	75,042,511	95,670,432	77,603,011	309,118,231
KPB Unincorporated	170,550,210	217,647,967	286,388,798	290,061,824	964,648,799
Total	356,045,834	472,147,472	619,255,890	520,057,790	1,967,506,986
2002					
Homer	44,264,946	68,671,745	89,690,601	60,568,508	263,195,800
Kenai	60,596,369	67,929,291	82,601,639	68,618,104	279,745,403
Seldovia	1,011,712	1,155,055	1,694,174	956,936	4,817,877
Seward	22,954,013	40,385,376	56,721,649	22,306,088	142,367,126
Soldotna	62,331,750	79,761,648	103,624,839	80,180,782	325,899,019
KPB Unincorporated	159,380,961	215,719,788	262,740,841	224,094,818	861,936,408
Total	350,539,751	473,622,903	597,073,743	456,725,236	1,877,961,633
2003					
Homer	50,849,790	75,260,620	87,128,272	60,184,407	273,423,089
Kenai	62,140,357	67,424,299	81,229,776	72,545,810	283,340,242
Seldovia	847,005	1,629,455	2,833,785	1,949,309	7,259,554
Seward	20,933,260	46,984,153	61,707,771	27,334,414	156,959,598
Soldotna	64,233,718	85,179,197	106,204,940	82,155,118	337,772,973
KPB Unincorporated	154,363,437	207,966,767	283,920,157	214,405,083	860,655,444
Total	353,367,567	484,444,491	623,024,701	458,574,141	1,919,410,900
2004					
Homer	49,013,511	69,367,583	93,766,064	72,065,062	284,212,220
Kenai	62,066,660	75,410,549	98,129,944	72,566,317	308,173,470
Seldovia	2,300,599	2,423,444	1,809,067	3,129,207	9,662,317
Seward	22,062,250	43,153,520	63,571,323	38,561,236	167,348,329
Soldotna	70,805,829	90,321,873	107,011,373	92,685,505	360,824,580
KPB Unincorporated	159,961,931	187,433,735	325,916,571	256,173,778	929,486,015
Total	366,210,780	468,110,704	690,204,342	535,181,105	2,059,706,931

Table 1.27

KPB Sales

KPB Annual TAXABLE Sales by AREA by Quarter - 1999-2004 - in \$					
	1st Qtr	2nd Qtr	3rd Qtr	4th Qtr	Total
1999					
Homer	16,638,467	26,938,559	34,247,729	20,323,983	98,148,738
Kenai	25,183,897	30,905,185	34,560,194	33,717,815	124,367,091
Seldovia	569,438	915,962	1,144,627	599,222	3,229,249
Seward	9,218,678	19,907,186	31,789,068	10,557,267	71,472,199
Soldotna	28,439,928	38,205,240	50,500,561	38,807,035	155,952,764
KPB Unincorporated	34,348,468	50,746,526	61,313,334	40,985,751	187,394,079
Total	114,398,876	167,618,658	213,555,513	144,991,073	640,564,120
2000					
Homer	17,327,860	28,797,872	35,677,211	21,387,173	103,190,116
Kenai	25,521,513	31,547,905	36,634,363	34,062,345	127,766,126
Seldovia	569,093	1,018,255	1,241,108	589,667	3,418,123
Seward	9,374,360	21,160,898	32,903,473	10,544,695	73,983,426
Soldotna	29,664,420	38,766,616	50,523,183	40,481,909	159,436,128
KPB Unincorporated	35,696,361	55,205,057	66,472,925	41,967,937	199,342,280
Total	118,153,607	176,496,603	223,452,263	149,033,726	667,136,199
2001					
Homer	17,765,204	30,191,477	37,574,702	21,780,156	107,311,539
Kenai	27,889,241	34,988,669	38,162,815	36,003,199	137,043,924
Seldovia	583,555	956,033	1,207,525	612,166	3,359,279
Seward	9,073,493	21,553,264	33,591,333	10,007,501	74,225,591
Soldotna	32,492,377	42,914,074	54,143,248	42,868,739	172,418,438
KPB Unincorporated	38,055,259	57,871,082	68,857,364	46,761,270	211,544,975
Total	125,859,129	188,474,599	233,536,987	158,033,031	705,903,746
2002					
Homer	18,697,104	34,267,489	43,251,111	25,052,414	121,268,118
Kenai	28,938,342	34,649,565	38,192,980	34,988,723	136,769,610
Seldovia	573,624	898,830	1,191,989	607,946	3,272,389
Seward	9,051,044	22,176,474	34,338,060	10,033,118	75,598,696
Soldotna	33,736,608	43,503,934	57,488,623	42,248,703	176,977,868
KPB Unincorporated	41,804,884	57,360,509	69,019,232	42,161,655	210,346,280
Total	132,801,606	192,856,801	243,481,995	155,092,559	724,232,961
2003					
Homer	22,445,940	37,025,784	45,079,765	27,071,736	131,623,225
Kenai	31,116,526	29,829,159	31,373,244	29,088,532	121,407,461
Seldovia	598,970	962,966	1,140,319	674,689	3,376,944
Seward	9,289,341	22,079,581	34,709,882	10,296,934	76,375,738
Soldotna	34,463,622	47,018,649	62,576,271	46,558,340	190,616,882
KPB Unincorporated	38,327,713	58,100,030	69,934,929	42,935,699	209,298,371
Total	136,242,112	195,016,169	244,814,410	156,625,930	732,698,621
2004					
Homer	23,821,088	39,642,214	48,965,416	27,272,024	139,700,742
Kenai	29,570,495	36,281,566	40,235,626	32,782,140	138,869,827
Seldovia	566,726	939,589	1,182,138	689,034	3,377,487
Seward	9,494,981	22,986,416	36,884,057	10,274,470	79,639,924
Soldotna	37,382,557	49,009,336	66,019,405	46,724,370	199,135,668
KPB Unincorporated	39,018,453	58,138,237	75,090,882	44,635,676	216,883,248
Total	139,854,300	206,997,358	268,377,524	162,377,714	777,606,896

Table 1.28

KPB Construction Permitting

KPB 4th Quarter Permit VALUES by AREA - 1998-2004 - in \$								
	1998	1999	2000	2001	2002	2003	2004	Annual Change
Homer	2,205,750	561,000	917,982	12,012,300	814,520	3,042,900	3,391,000	11.4%
Kenai	595,300	1,057,000	678,200	655,300	1,527,800	2,455,500	585,400	-76.2%
Seldovia	0	18,000	5,000	15,000	20,000	36,500	0	-100.0%
Seward	299,600	503,000	619,400	992,000	2,232,800	572,500	259,350	-54.7%
Soldotna	759,160	509,793	1,402,952	162,648	257,500	873,045	4,703,915	438.8%
Total	3,859,810	2,648,793	3,623,534	13,837,248	4,852,620	6,980,445	8,939,665	28.1%
Annual Change		-31.4%	36.8%	281.9%	-64.9%	43.8%	28.1%	

Table 1.29

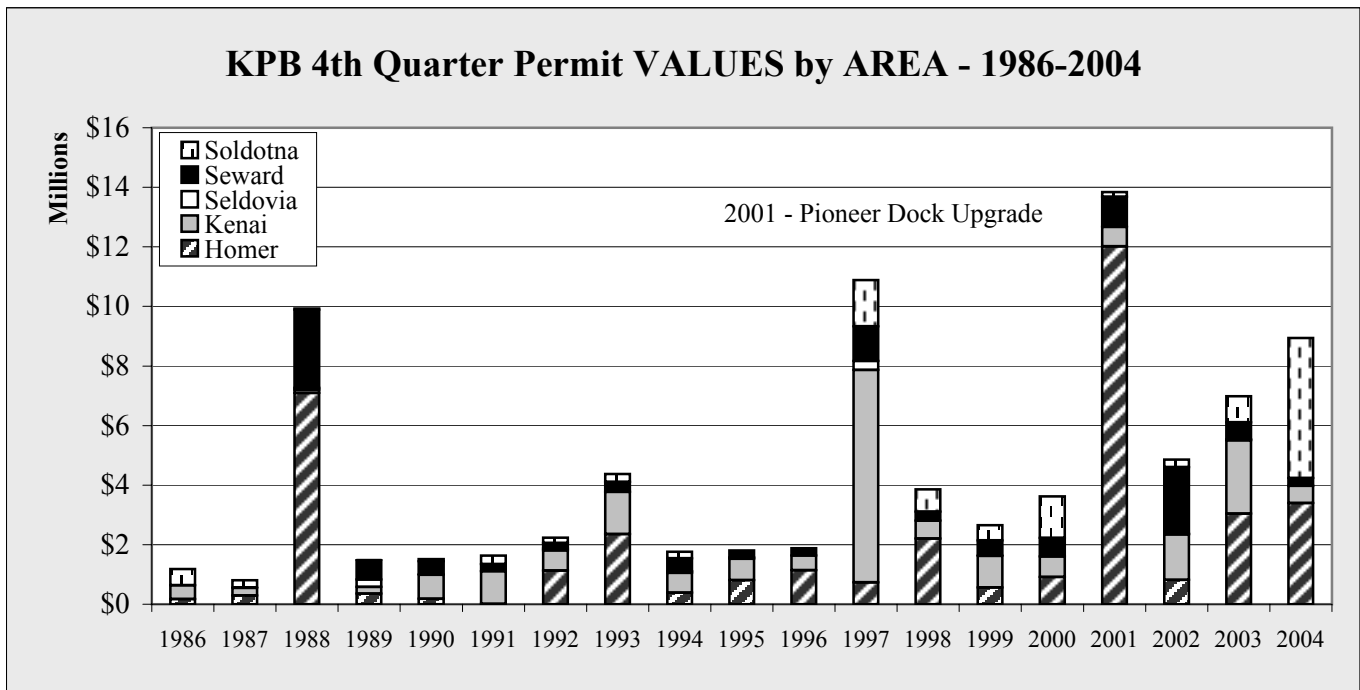

Chart 1.19

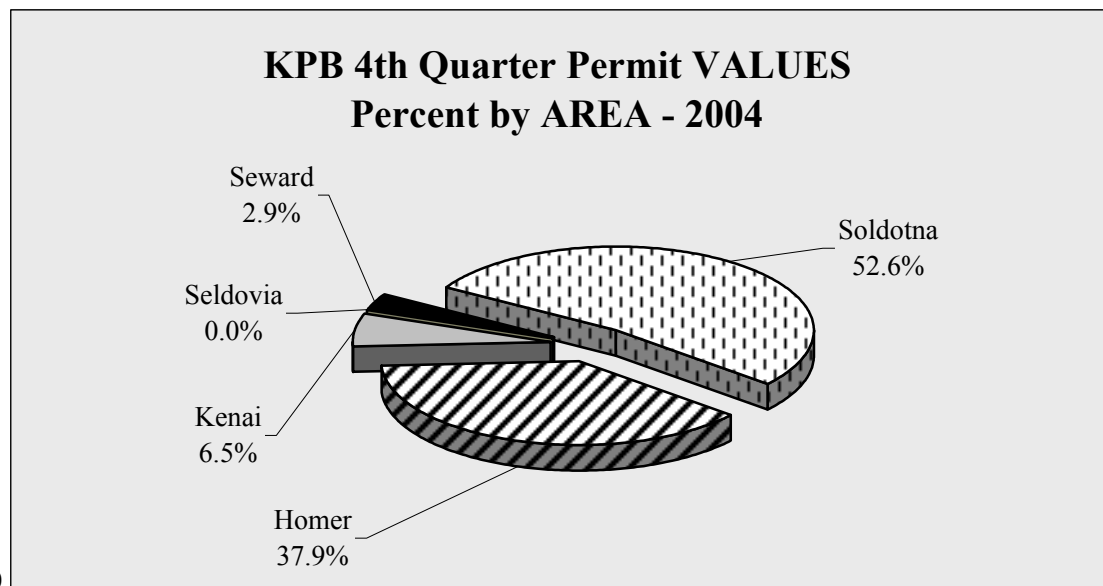

Chart 1.20

KPB Construction Permitting

KPB 4th Quarter Permit VALUES by TYPE - 1998-2004 - in \$								
	1998	1999	2000	2001	2002	2003	2004	Annual Change
Residential New	1,352,750	1,245,888	972,668	1,116,300	1,113,200	2,554,091	1,153,860	-54.8%
Residential Alter/Add	234,960	291,400	439,300	348,948	225,620	291,000	529,454	81.9%
Commercial New	1,868,000	962,905	1,462,484	514,000	3,168,000	2,146,991	3,061,601	42.6%
Commercial Alter/Add	404,100	148,600	749,082	11,858,000	345,800	1,988,363	4,194,750	111.0%
Total	3,859,810	2,648,793	3,623,534	13,837,248	4,852,620	6,980,445	8,939,665	28.1%
Annual Change		-31.4%	36.8%	281.9%	-64.9%	43.8%	28.1%	

Table 1.30

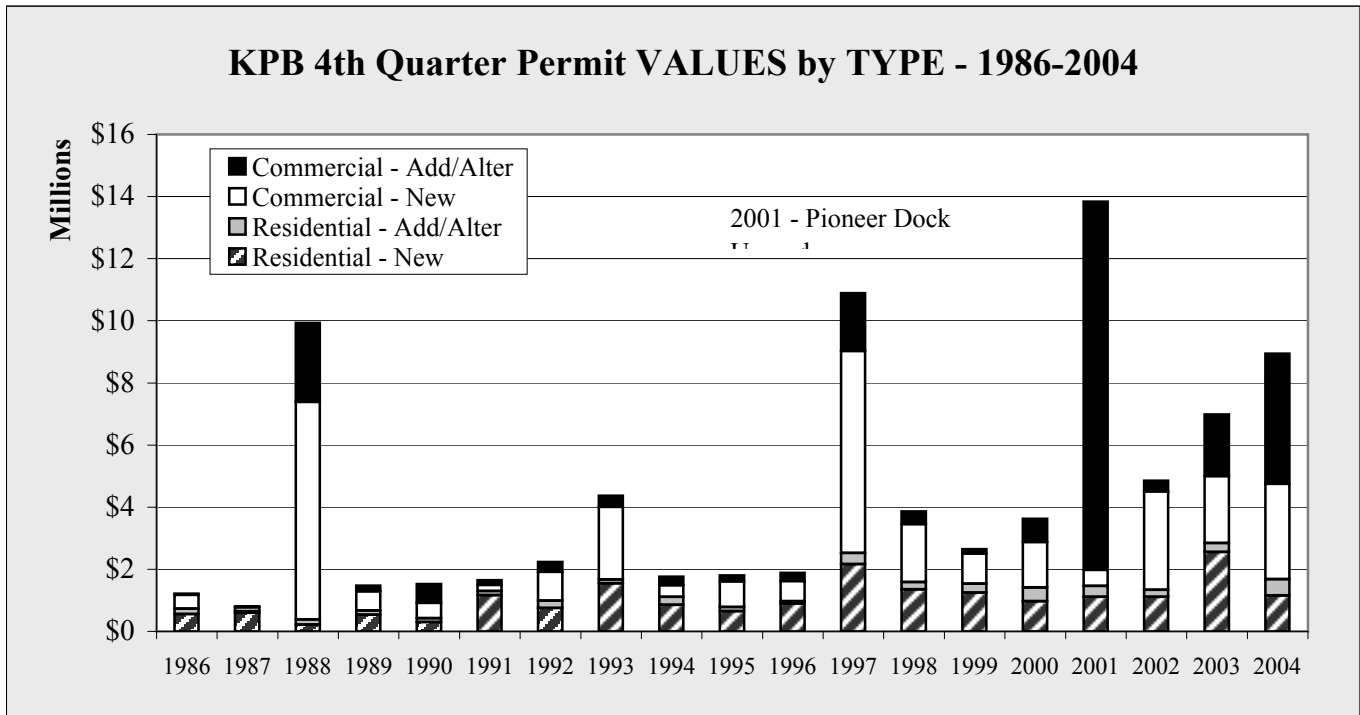

Chart 1.21

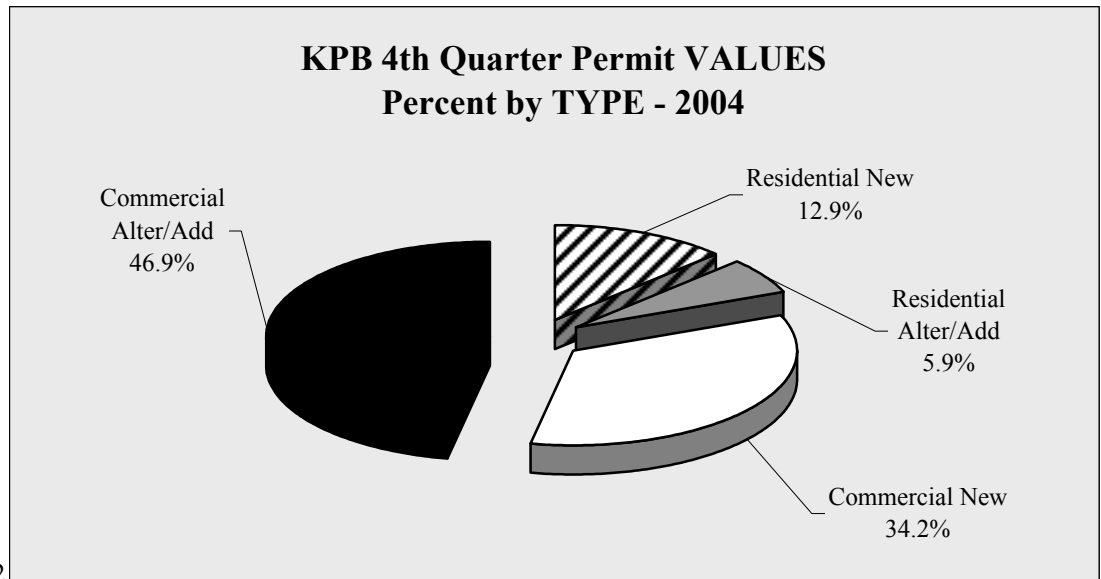

Chart 1.22

KPB Construction Permitting

KPB 4th Quarter Permit VOLUME by AREA - 1998-2004

	1998	1999	2000	2001	2002	2003	2004	Annual Change
Homer	10	6	8	9	13	13	24	84.6%
Kenai	18	22	13	11	20	21	14	-33.3%
Seldovia	0	3	1	2	1	4	0	-100.0%
Seward	7	10	9	9	11	11	7	-36.4%
Soldotna	14	9	20	11	4	13	8	-38.5%
Total	49	50	51	42	49	62	53	-14.5%
Annual Change		2.0%	2.0%	-17.6%	16.7%	26.5%	-14.5%	

Table 1.31

KPB 4th Quarter Permit VOLUME by AREA - 1986-2004

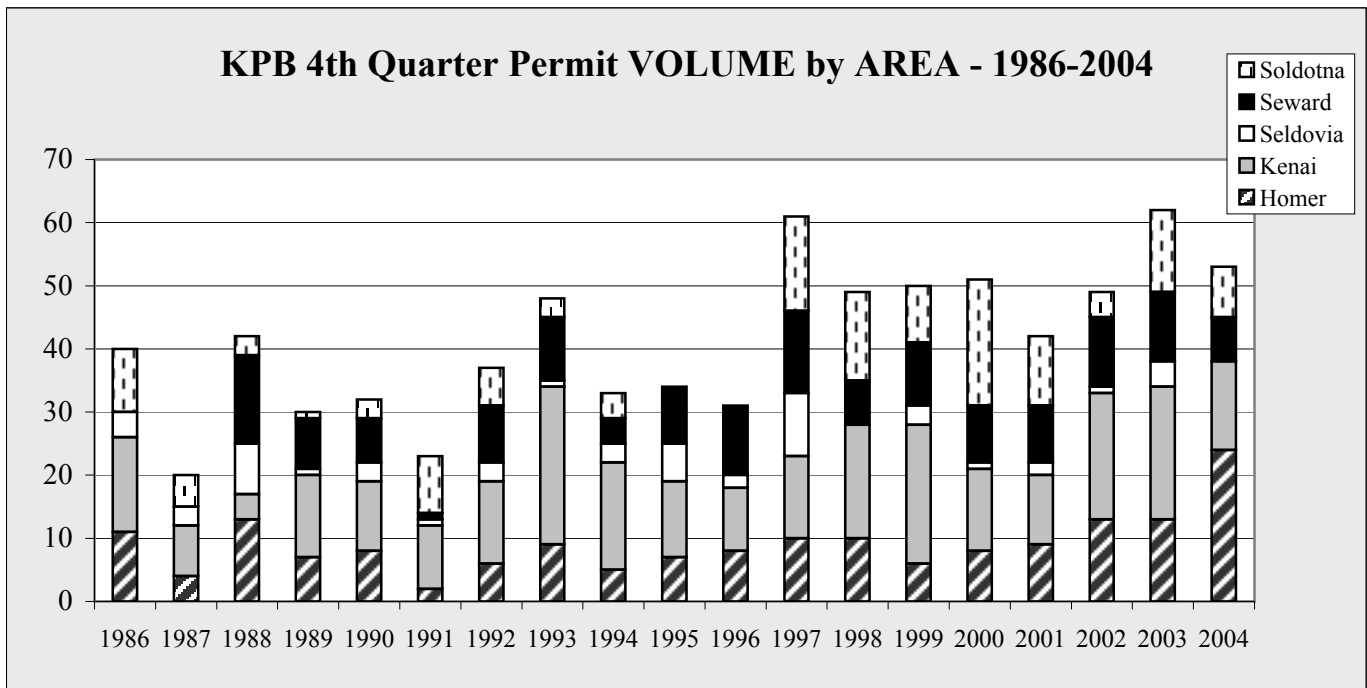

Chart 1.23

**KPB 4th Quarter Permit VOLUME
Percent by AREA - 2004**

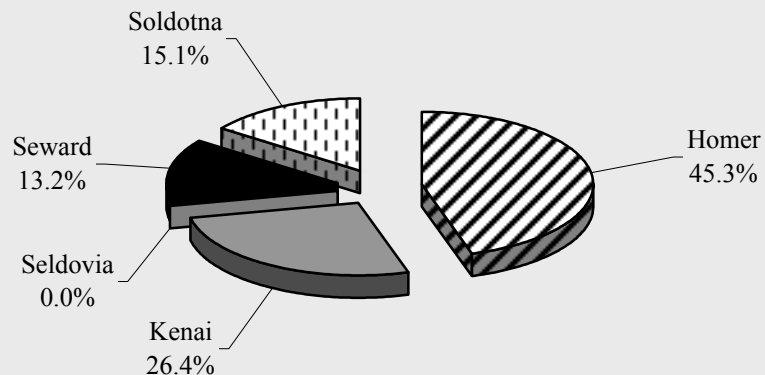

Chart 1.24

KPB Construction Permitting

KPB 4th Quarter Permit VOLUME by TYPE - 1998-2004								
	1998	1999	2000	2001	2002	2003	2004	Annual Change
Residential New	10	13	9	8	9	22	11	-50.0%
Residential Alter/Add	17	18	15	14	17	10	17	70.0%
Commercial New	6	9	12	2	7	7	9	28.6%
Commercial Alter/Add	16	10	15	18	16	23	16	-30.4%
Total	49	50	51	42	49	62	53	-14.5%
Annual Change		2.0%	2.0%	-17.6%	16.7%	26.5%	-14.5%	

Table 1.32

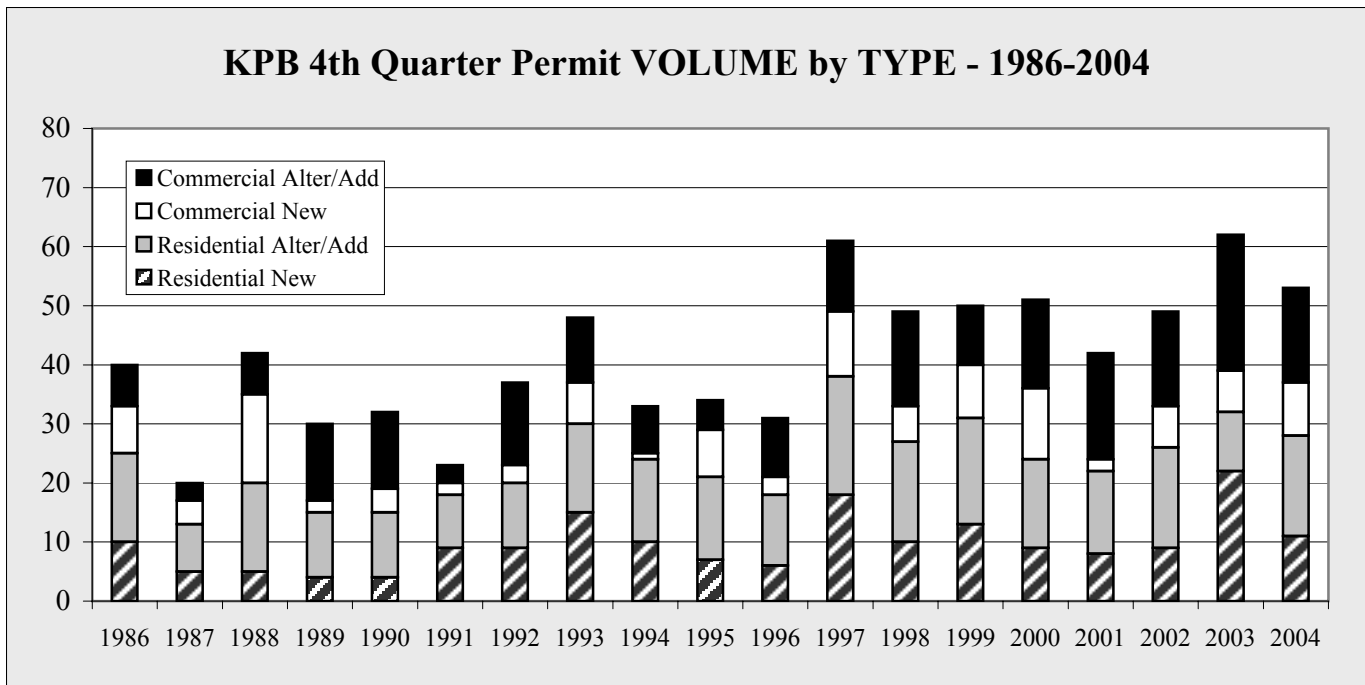

Chart 1.25

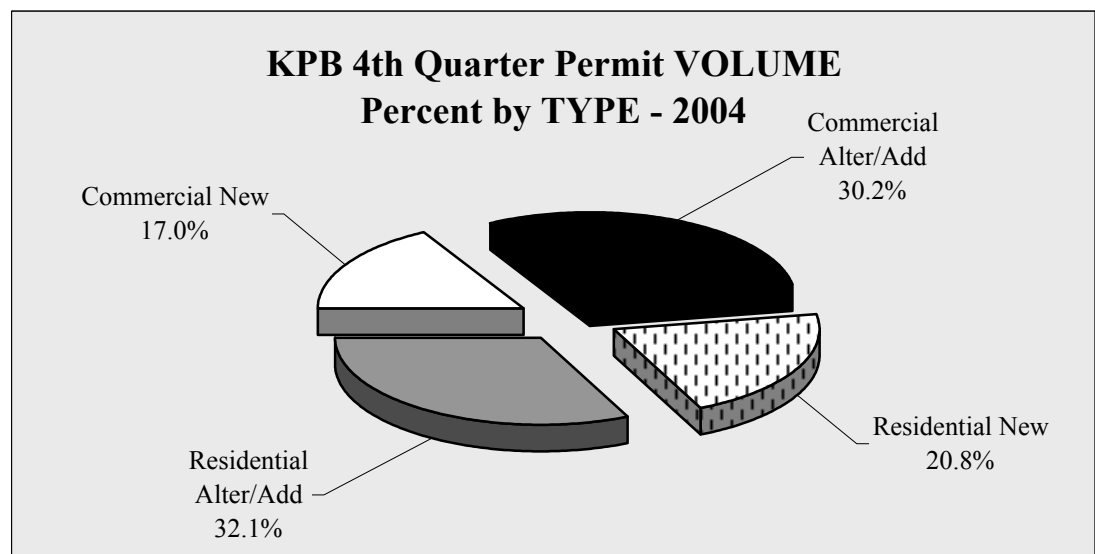

Chart 1.26

KPB Construction Permitting

KPB Annual Permit VALUES by AREA - 1998-2004 - in \$								
	1998	1999	2000	2001	2002	2003	2004	Annual Change
Homer	6,199,875	10,940,000	7,128,972	19,800,690	10,048,779	15,326,815	24,070,631	57.0%
Kenai	7,642,200	9,441,750	9,398,100	13,578,900	16,799,400	10,441,800	4,786,550	-54.2%
Seldovia	0	479,000	109,200	65,525	356,500	1,902,500	176,200	-90.7%
Seward	6,747,861	4,241,413	3,451,565	2,716,981	7,910,703	7,982,765	17,711,150	121.9%
Soldotna	9,621,817	9,505,120	8,167,420	8,954,972	11,163,894	7,952,297	37,296,926	369.0%
Total	30,211,753	34,607,283	28,255,257	45,117,068	46,279,276	43,606,177	84,041,457	92.7%
Annual Change		14.5%	-18.4%	59.7%	2.6%	-5.8%	92.7%	

Table 1.33

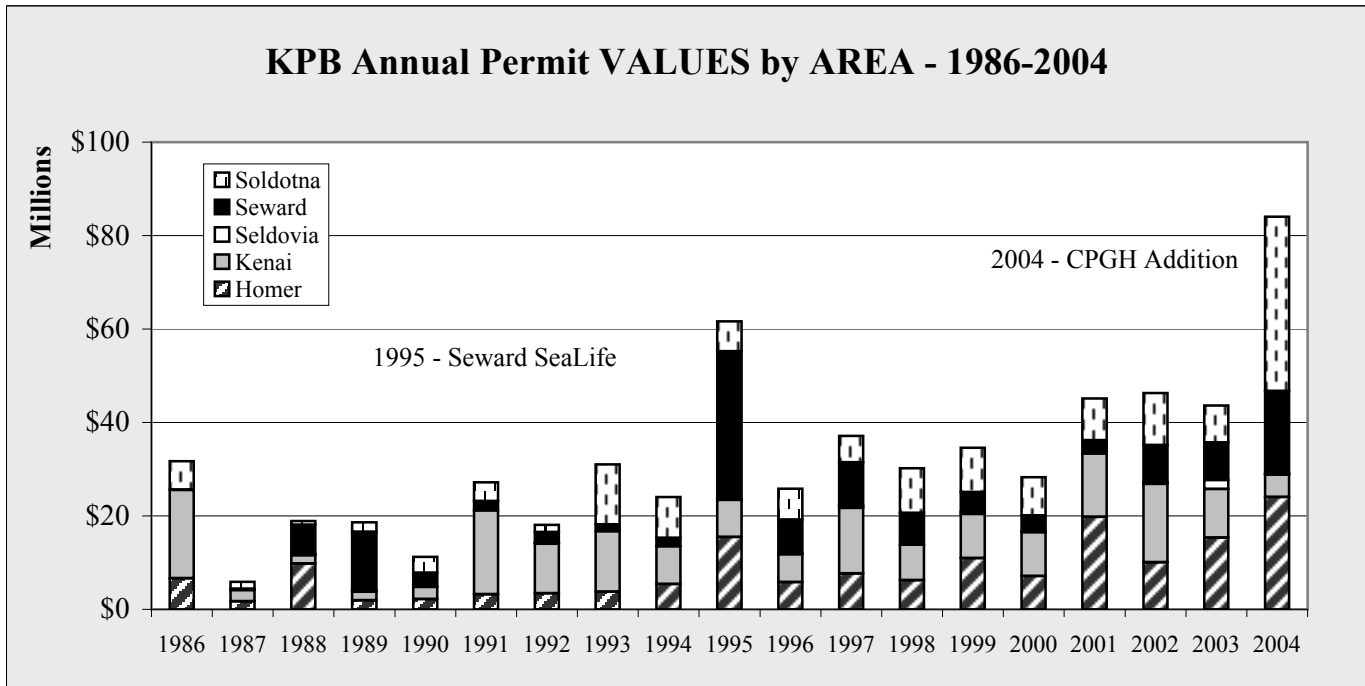

Chart 1.27

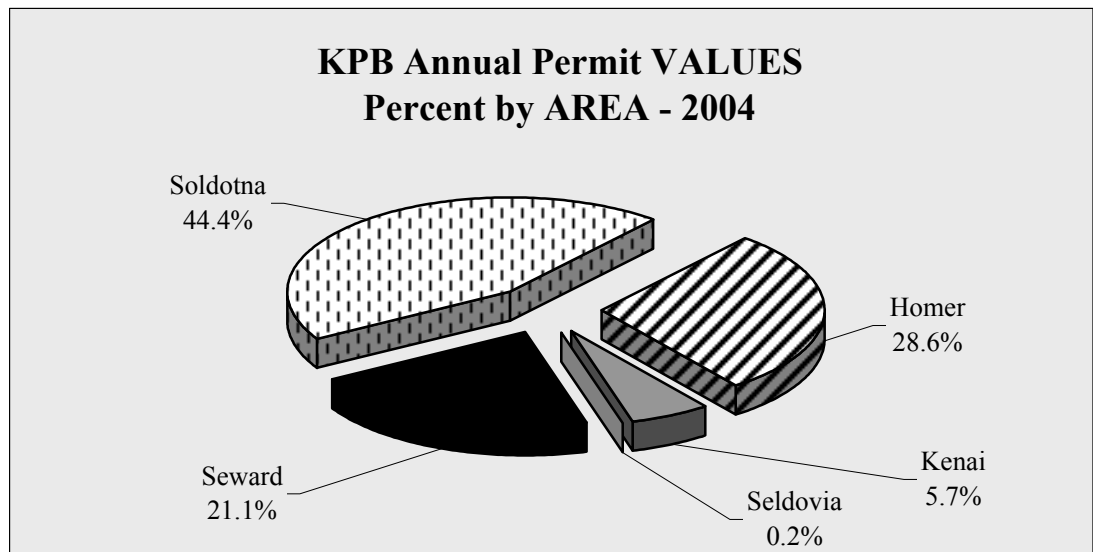

Chart 1.28

KPB Construction Permitting

KPB Annual Permit VALUES by TYPE - 1998-2004 - in \$

	1998	1999	2000	2001	2002	2003	2004	Annual Change
Residential New	12,376,250	11,395,862	9,885,058	13,391,633	14,358,064	15,729,888	15,935,344	1.3%
Residential Alter/Add	1,747,903	1,834,828	1,990,399	1,996,494	2,305,815	2,280,779	2,880,284	26.3%
Commercial New	13,494,922	18,862,564	10,662,544	11,565,350	21,793,729	15,820,201	56,079,343	254.5%
Commercial Alter/Add	2,592,678	2,514,029	5,717,256	18,163,591	7,821,668	9,775,309	9,146,486	-6.4%
Total	30,211,753	34,607,283	28,255,257	45,117,068	46,279,276	43,606,177	84,041,457	92.7%
Annual Change		14.5%	-18.4%	59.7%	2.6%	-5.8%	92.7%	

Table 1.34

KPB Annual Permit VALUES by TYPE - 1986-2004

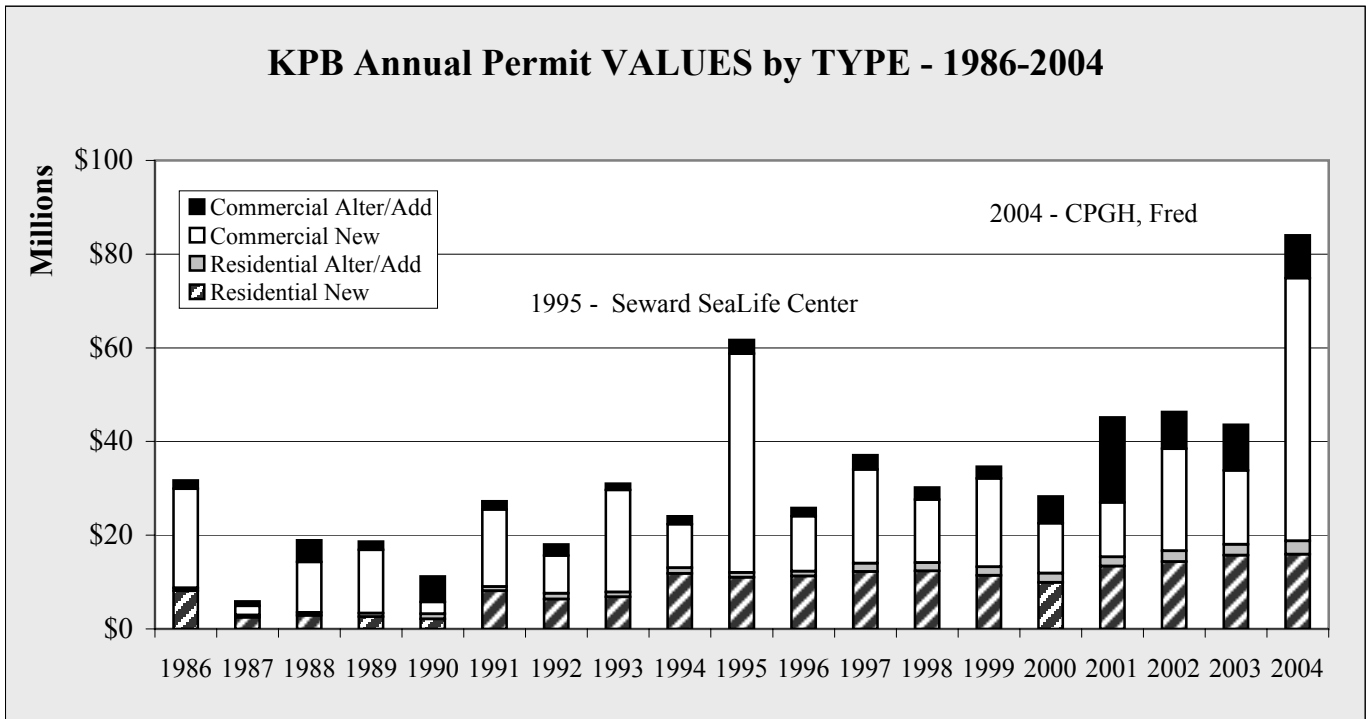

Chart 1.29

**KPB Annual Permit VALUES
Percent by TYPE - 2004**

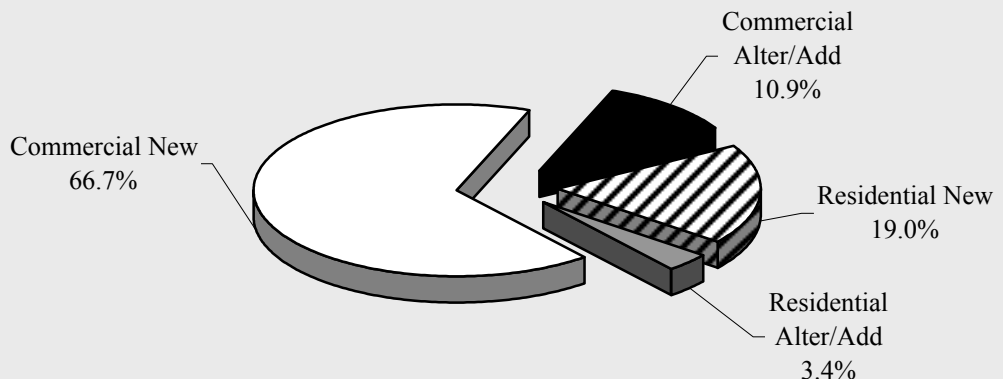

Chart 1.30

KPB Construction Permitting

KPB Annual Permit VOLUME by AREA - 1998-2004

	1998	1999	2000	2001	2002	2003	2004	Annual Change
Homer	48	52	58	72	67	86	108	25.6%
Kenai	97	102	93	87	121	114	79	-30.7%
Seldovia	0	20	13	9	8	12	4	-66.7%
Seward	49	56	51	48	64	50	54	8.0%
Soldotna	77	77	88	93	91	74	67	-9.5%
Total	271	307	303	309	351	336	312	-7.1%
Annual Change		13.3%	-1.3%	2.0%	13.6%	-4.3%	-7.1%	

Table 1.35

KPB Annual Permit VOLUME by AREA - 1986-2004

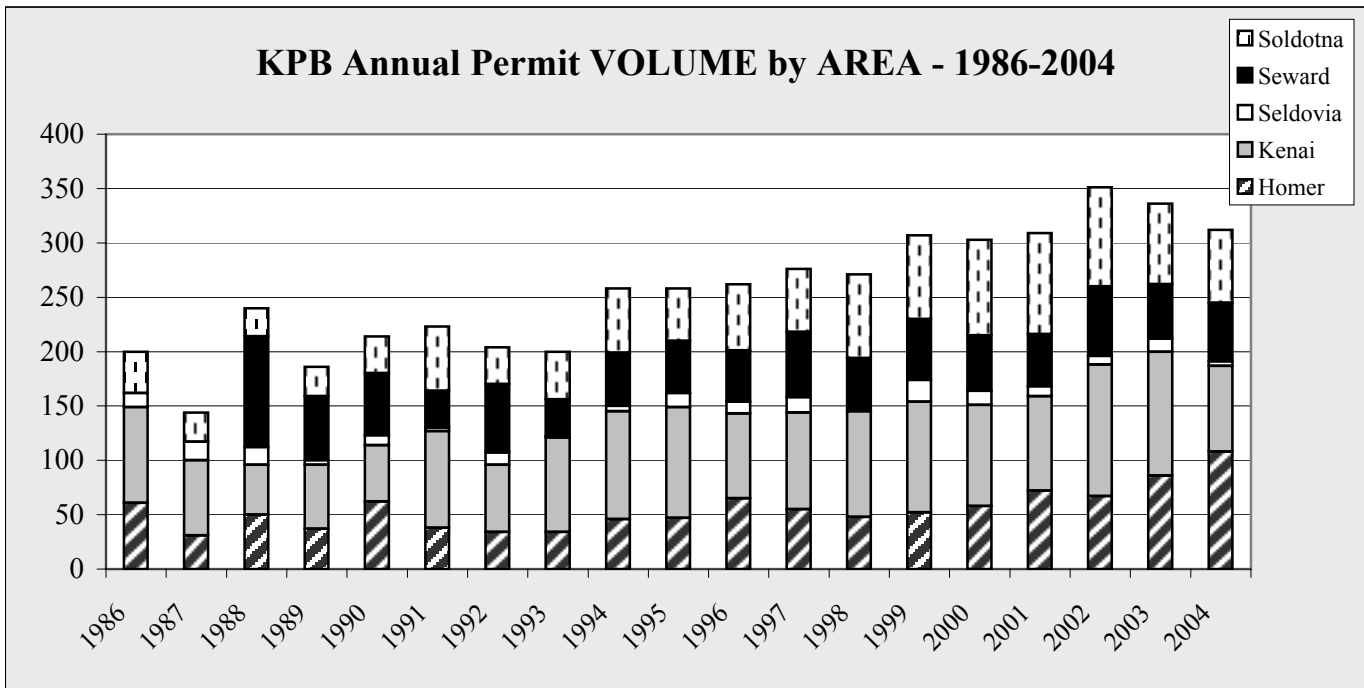

Chart 1.31

**KPB Annual Permit VOLUME
Percent by AREA - 2004**

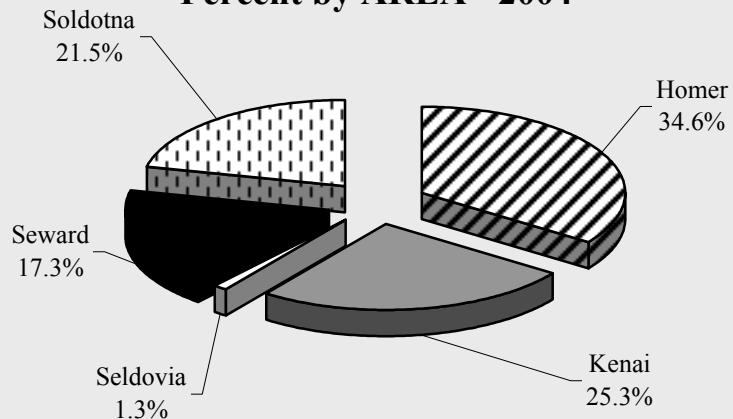

Chart 1.32

KPB Construction Permitting

KPB Annual Permit VOLUME by TYPE - 1998-2004								
	1998	1999	2000	2001	2002	2003	2004	Annual Change
Residential New	92	79	79	89	104	104	94	-9.6%
Residential Alter/Add	78	98	97	96	116	94	96	2.1%
Commercial New	48	57	45	32	43	42	42	0.0%
Commercial Alter/Add	53	73	82	92	88	96	80	-16.7%
Total	271	307	303	309	351	336	312	-7.1%
Annual Change		13.3%	-1.3%	2.0%	13.6%	-4.3%	-7.1%	

Table 1.36

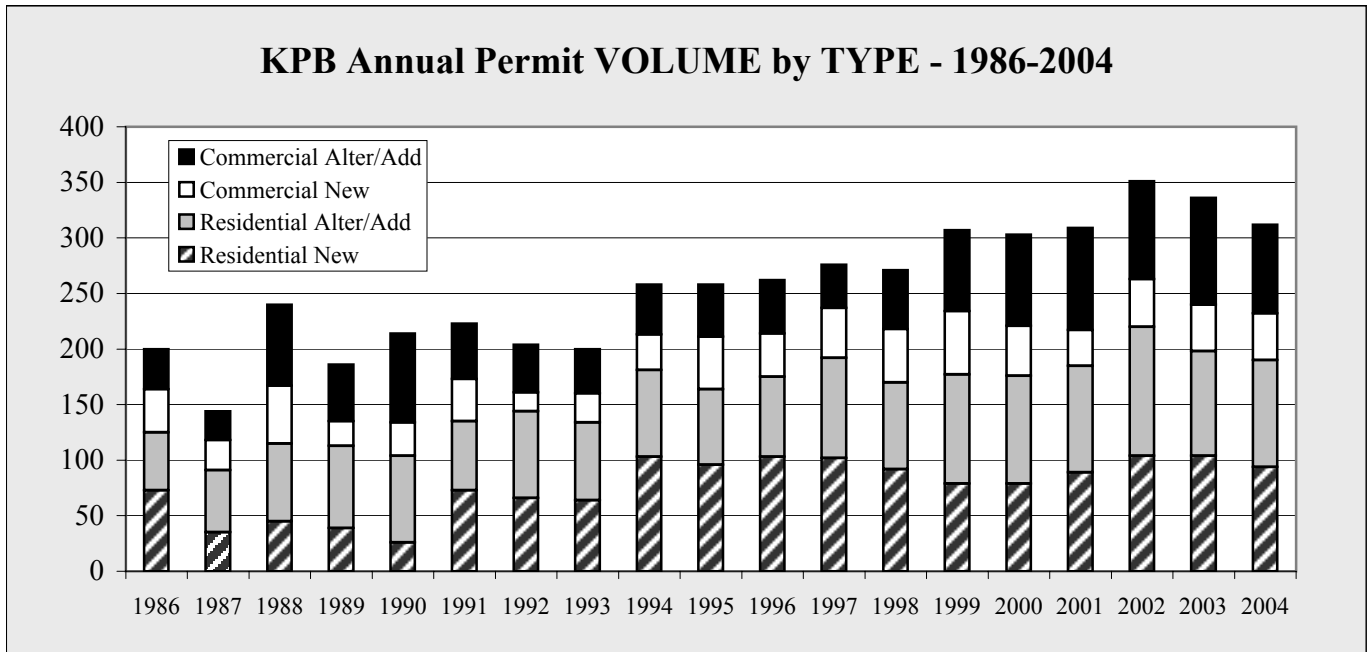

Chart 1.33

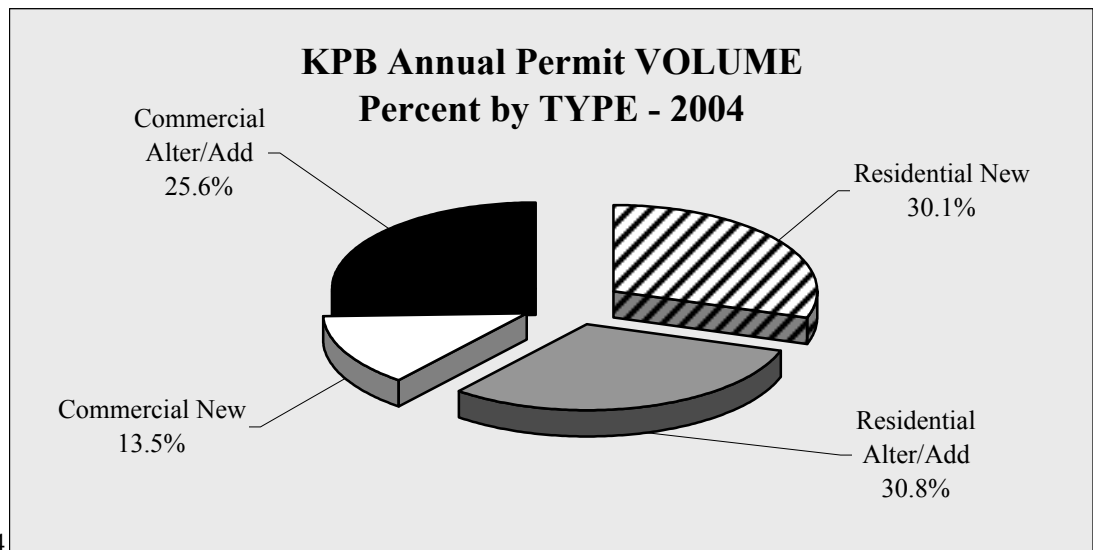

Chart 1.34

KPB Construction Permitting

KPB Annual Permit VALUES by AREA by Quarter - 1998-2004 - in \$					
	1st Quarter	2nd Quarter	3rd Quarter	4th Quarter	Total
1998					
Homer	629,970	2,273,936	1,090,219	2,205,750	6,199,875
Kenai	470,500	4,401,500	2,174,900	595,300	7,642,200
Seldovia	0	0	0	0	0
Seward	703,075	959,000	4,786,186	299,600	6,747,861
Soldotna	230,094	3,493,400	5,139,163	759,160	9,621,817
TOTAL	2,033,639	11,127,836	13,190,468	3,859,810	30,211,753
1999					
Homer	1,943,000	2,691,000	5,745,000	561,000	10,940,000
Kenai	239,500	2,022,600	6,122,650	1,057,000	9,441,750
Seldovia	8,000	365,500	87,500	18,000	479,000
Seward	1,040,550	1,082,114	1,615,749	503,000	4,241,413
Soldotna	83,696	4,785,052	4,126,579	509,793	9,505,120
TOTAL	3,314,746	10,946,266	17,697,478	2,648,793	34,607,283
2000					
Homer	1,798,100	2,265,920	2,146,970	917,982	7,128,972
Kenai	462,900	3,163,000	5,094,000	678,200	9,398,100
Seldovia	24,000	22,300	57,900	5,000	109,200
Seward	355,300	1,765,400	711,465	619,400	3,451,565
Soldotna	1,078,202	4,009,356	1,676,910	1,402,952	8,167,420
TOTAL	3,718,502	11,225,976	9,687,245	3,623,534	28,255,257
2001					
Homer	690,000	4,102,040	2,996,350	12,012,300	19,800,690
Kenai	819,500	7,597,900	4,506,200	655,300	13,578,900
Seldovia	10,000	25,000	15,525	15,000	65,525
Seward	416,700	666,239	642,042	992,000	2,716,981
Soldotna	3,051,218	3,231,190	2,509,916	162,648	8,954,972
TOTAL	4,987,418	15,622,369	10,670,033	13,837,248	45,117,068
2002					
Homer	928,720	2,528,209	5,777,330	814,520	10,048,779
Kenai	3,888,200	4,569,400	6,814,000	1,527,800	16,799,400
Seldovia	10,000	8,000	318,500	20,000	356,500
Seward	481,440	3,888,887	1,307,576	2,232,800	7,910,703
Soldotna	1,205,590	7,003,458	2,697,346	257,500	11,163,894
TOTAL	6,513,950	17,997,954	16,914,752	4,852,620	46,279,276
2003					
Homer	1,334,340	7,929,500	3,020,075	3,042,900	15,326,815
Kenai	1,557,600	2,728,350	3,700,350	2,455,500	10,441,800
Seldovia	31,000	0	1,835,000	36,500	1,902,500
Seward	1,905,355	3,672,010	1,832,900	572,500	7,982,765
Soldotna	427,018	4,233,924	2,418,310	873,045	7,952,297
TOTAL	5,255,313	18,563,784	12,806,635	6,980,445	43,606,177
2004					
Homer	3,714,020	7,433,711	9,531,900	3,391,000	24,070,631
Kenai	312,000	1,897,400	1,991,750	585,400	4,786,550
Seldovia	20,000	156,200	0	0	176,200
Seward	7,741,600	7,443,900	2,266,300	259,350	17,711,150
Soldotna	5,064,323	3,748,573	23,780,115	4,703,915	37,296,926
TOTAL	16,851,943	20,679,784	37,570,065	8,939,665	84,041,457

Table 1.37

KPB Construction Permitting

KPB Annual Permit VALUES by TYPE by Quarter - 1997-2004 - in \$					
	1st Quarter	2nd Quarter	3rd Quarter	4th Quarter	Total
1997					
Residential - New	1,066,900	5,896,055	3,065,151	2,168,300	12,196,406
Residential - Add/Alter	115,000	849,692	461,865	351,400	1,777,957
Commercial - New	6,853,000	4,602,300	2,100,000	6,504,650	20,059,950
Commercial - Add/Alter	135,300	226,186	858,900	1,861,469	3,081,855
TOTAL	8,170,200	11,574,233	6,485,916	10,885,819	37,116,168
1998					
Residential - New	887,500	6,367,500	3,623,500	1,352,750	12,376,250
Residential - Add/Alter	93,543	879,900	539,500	234,960	1,747,903
Commercial - New	585,754	3,600,436	7,440,732	1,868,000	13,494,922
Commercial - Add/Alter	321,842	280,000	1,586,736	404,100	2,592,678
TOTAL	2,033,639	11,127,836	13,190,468	3,859,810	30,211,753
1999					
Residential - New	1,673,000	4,754,674	3,722,300	1,245,888	11,395,862
Residential - Add/Alter	181,200	667,961	694,267	291,400	1,834,828
Commercial - New	292,500	4,798,818	12,808,341	962,905	18,862,564
Commercial - Add/Alter	1,168,046	724,813	472,570	148,600	2,514,029
TOTAL	3,314,746	10,946,266	17,697,478	2,648,793	34,607,283
2000					
Residential - New	1,242,529	4,531,931	3,137,930	972,668	9,885,058
Residential - Add/Alter	18,500	860,574	672,025	439,300	1,990,399
Commercial - New	669,273	3,564,122	4,966,665	1,462,484	10,662,544
Commercial - Add/Alter	1,788,200	2,269,349	910,625	749,082	5,717,256
TOTAL	3,718,502	11,225,976	9,687,245	3,623,534	28,255,257
2001					
Residential - New	923,000	7,367,801	3,984,532	1,116,300	13,391,633
Residential - Add/Alter	356,860	758,779	531,907	348,948	1,996,494
Commercial - New	2,958,578	5,384,800	2,707,972	514,000	11,565,350
Commercial - Add/Alter	748,980	2,110,989	3,445,622	11,858,000	18,163,591
TOTAL	4,987,418	15,622,369	10,670,033	13,837,248	45,117,068
2002					
Residential - New	1,531,609	6,145,753	5,567,502	1,113,200	14,358,064
Residential - Add/Alter	159,391	1,044,943	875,861	225,620	2,305,815
Commercial - New	4,294,006	8,376,305	5,955,418	3,168,000	21,793,729
Commercial - Add/Alter	528,944	2,430,953	4,515,971	345,800	7,821,668
TOTAL	6,513,950	17,997,954	16,914,752	4,852,620	46,279,276
2003					
Residential - New	1,097,800	7,868,834	4,209,163	2,554,091	15,729,888
Residential - Add/Alter	393,867	984,340	611,572	291,000	2,280,779
Commercial - New	72,000	8,965,210	4,636,000	2,146,991	15,820,201
Commercial - Add/Alter	3,691,646	745,400	3,349,900	1,988,363	9,775,309
TOTAL	5,255,313	18,563,784	12,806,635	6,980,445	43,606,177
2004					
Residential - New	3,456,797	6,374,487	4,950,200	1,153,860	15,935,344
Residential - Add/Alter	261,520	483,839	1,605,471	529,454	2,880,284
Commercial - New	12,880,026	11,147,815	28,989,901	3,061,601	56,079,343
Commercial - Add/Alter	253,600	2,673,643	2,024,493	4,194,750	9,146,486
TOTAL	16,851,943	20,679,784	37,570,065	8,939,665	84,041,457

Table 1.38

KPB Construction Permitting

KPB Annual Permit VOLUME by AREA by Quarter - 1998-2004					
	1st Quarter	2nd Quarter	3rd Quarter	4th Quarter	Total
1998					
Homer	6	18	14	10	48
Kenai	10	39	30	18	97
Seldovia	0	0	0	0	0
Seward	9	20	13	7	49
Soldotna	8	27	28	14	77
TOTAL	33	104	85	49	271
1999					
Homer	5	21	20	6	52
Kenai	7	33	40	22	102
Seldovia	1	9	7	3	20
Seward	5	18	23	10	56
Soldotna	10	35	23	9	77
TOTAL	28	116	113	50	307
2000					
Homer	9	20	21	8	58
Kenai	8	36	36	13	93
Seldovia	3	3	6	1	13
Seward	5	20	17	9	51
Soldotna	8	34	26	20	88
TOTAL	33	113	106	51	303
2001					
Homer	7	34	22	9	72
Kenai	11	42	23	11	87
Seldovia	1	1	5	2	9
Seward	11	14	14	9	48
Soldotna	10	37	35	11	93
TOTAL	40	128	99	42	309
2002					
Homer	10	17	27	13	67
Kenai	5	37	59	20	121
Seldovia	1	2	4	1	8
Seward	10	29	14	11	64
Soldotna	11	51	25	4	91
TOTAL	37	136	129	49	351
2003					
Homer	18	34	21	13	86
Kenai	8	40	45	21	114
Seldovia	3	0	5	4	12
Seward	11	13	15	11	50
Soldotna	6	36	19	13	74
TOTAL	46	123	105	62	336
2004					
Homer	16	26	42	24	108
Kenai	4	30	31	14	79
Seldovia	1	3	0	0	4
Seward	7	21	19	7	54
Soldotna	9	26	24	8	67
TOTAL	37	106	116	53	312

Table 1.39

KPB Construction Permitting

KPB Annual Permit VOLUME by TYPE by Quarter - 1997-2004					
	1st Quarter	2nd Quarter	3rd Quarter	4th Quarter	Total
1997					
Residential - New	8	50	26	18	102
Residential - Add/Alter	4	38	28	20	90
Commercial - New	6	13	15	11	45
Commercial - Add/Alter	8	5	14	12	39
TOTAL	26	106	83	61	276
1998					
Residential - New	9	45	28	10	92
Residential - Add/Alter	9	24	28	17	78
Commercial - New	6	19	17	6	48
Commercial - Add/Alter	9	16	12	16	53
TOTAL	33	104	85	49	271
1999					
Residential - New	3	38	25	13	79
Residential - Add/Alter	8	36	36	18	98
Commercial - New	4	20	24	9	57
Commercial - Add/Alter	13	22	28	10	73
TOTAL	28	116	113	50	307
2000					
Residential - New	10	32	28	9	79
Residential - Add/Alter	4	38	40	15	97
Commercial - New	4	13	16	12	45
Commercial - Add/Alter	15	30	22	15	82
TOTAL	33	113	106	51	303
2001					
Residential - New	7	45	29	8	89
Residential - Add/Alter	13	38	31	14	96
Commercial - New	6	9	15	2	32
Commercial - Add/Alter	14	36	24	18	92
TOTAL	40	128	99	42	309
2002					
Residential - New	12	45	38	9	104
Residential - Add/Alter	8	42	49	17	116
Commercial - New	5	17	14	7	43
Commercial - Add/Alter	12	32	28	16	88
TOTAL	37	136	129	49	351
2003					
Residential - New	7	47	28	22	104
Residential - Add/Alter	17	33	34	10	94
Commercial - New	1	17	17	7	42
Commercial - Add/Alter	21	26	26	23	96
TOTAL	46	123	105	62	336
2004					
Residential - New	17	34	32	11	94
Residential - Add/Alter	5	30	44	17	96
Commercial - New	7	11	15	9	42
Commercial - Add/Alter	8	31	25	16	80
TOTAL	37	106	116	53	312

Table 1.40

KPB Employment

Employment data are acquired from the Alaska Department of Labor and Workforce Development (AK DOLWD) as reported by each business.

Government employees include federal, state, borough and local government as well as public school and state university employees. Employees of both Central Peninsula General Hospital in Soldotna and South Peninsula General Hospital in Homer are included in government data rather than service data because they are owned by and receive funds from the KPB.

The AK DOLWD updates employment data regularly. Self-employed workers, fishers, domestics, unpaid family help, most individuals engaged in agriculture and some other smaller worker groups are excluded from these figures due to exemption from certain reporting requirements.

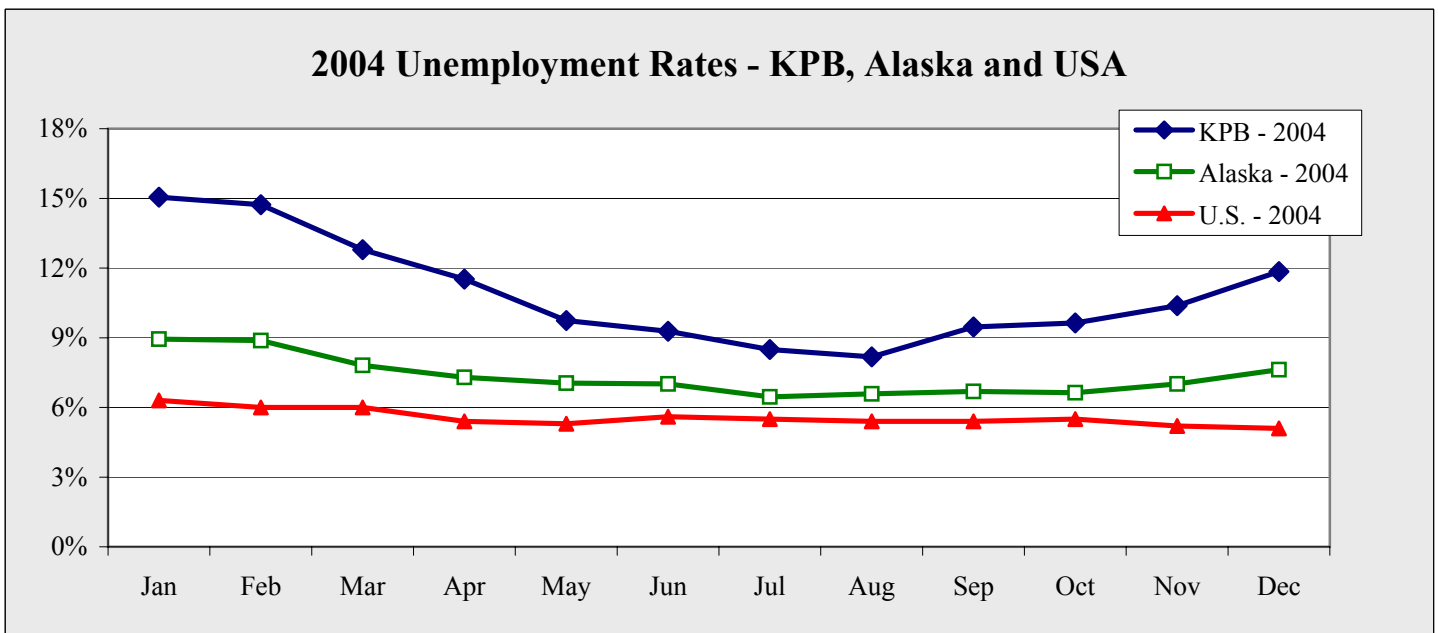

Chart 1.35

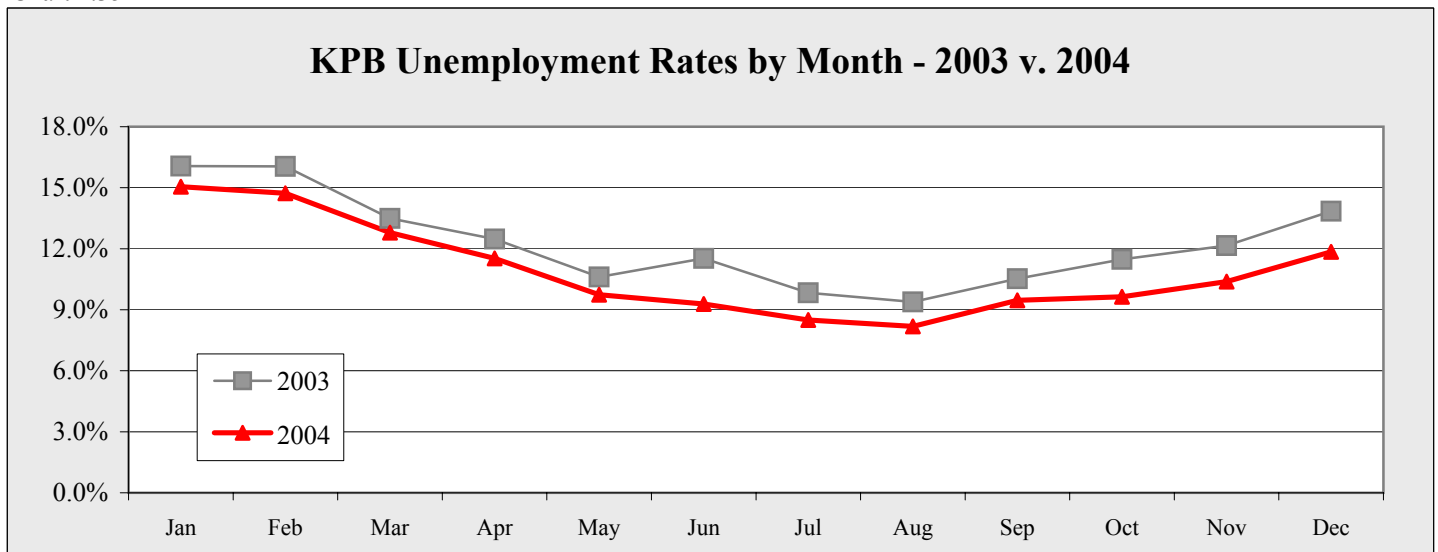

Chart 1.36

KPB Employment

KPB Labor Force by Month - 1990-2004													
	Jan	Feb	Mar	Apr	May	Jun	Jul	Aug	Sep	Oct	Nov	Dec	Avg
1990	17,484	17,834	17,907	18,562	19,163	20,281	21,497	20,995	18,632	18,592	18,087	17,804	18,903
1991	18,314	18,612	18,738	19,469	19,806	20,852	22,525	21,608	19,981	19,045	18,919	18,574	19,704
1992	18,749	19,468	19,366	19,734	20,218	22,206	22,766	21,409	20,614	20,300	19,409	19,138	20,281
1993	18,526	19,509	19,827	20,175	20,457	22,835	24,085	23,031	20,626	20,550	19,792	19,293	20,726
1994	19,602	21,104	21,193	20,557	21,046	23,263	24,611	23,372	21,078	20,922	20,057	19,392	21,350
1995	20,603	21,179	20,971	20,505	21,100	22,740	24,340	23,498	21,559	21,432	20,441	19,915	21,524
1996	20,902	21,795	21,739	21,609	22,651	24,000	25,583	24,841	23,228	21,906	21,335	20,561	22,513
1997	21,742	22,421	21,898	21,993	22,076	24,208	25,480	24,414	22,467	21,325	20,589	19,953	22,381
1998	20,677	20,713	20,426	20,395	21,346	23,475	24,773	24,319	22,567	21,208	20,112	19,520	21,628
1999	20,429	21,171	20,932	21,048	21,466	23,076	24,114	23,381	22,244	21,096	20,202	19,727	21,574
2000	21,124	21,702	21,320	21,161	21,850	23,135	24,265	23,419	21,584	21,019	20,260	19,987	21,736
2001	20,652	21,047	20,856	20,741	21,536	22,920	24,826	23,766	22,082	21,091	20,377	20,221	21,676
2002	20,596	20,969	21,108	21,305	21,893	22,863	24,201	23,601	22,099	20,554	21,261	20,446	21,741
2003	21,352	21,664	21,497	21,572	22,197	21,986	25,029	24,314	22,432	21,628	21,026	20,637	22,111
2004	21,684	22,018	21,837	21,986	22,687	24,535	25,501	24,867	22,823	21,856	21,404	20,803	22,667

Table 1.41

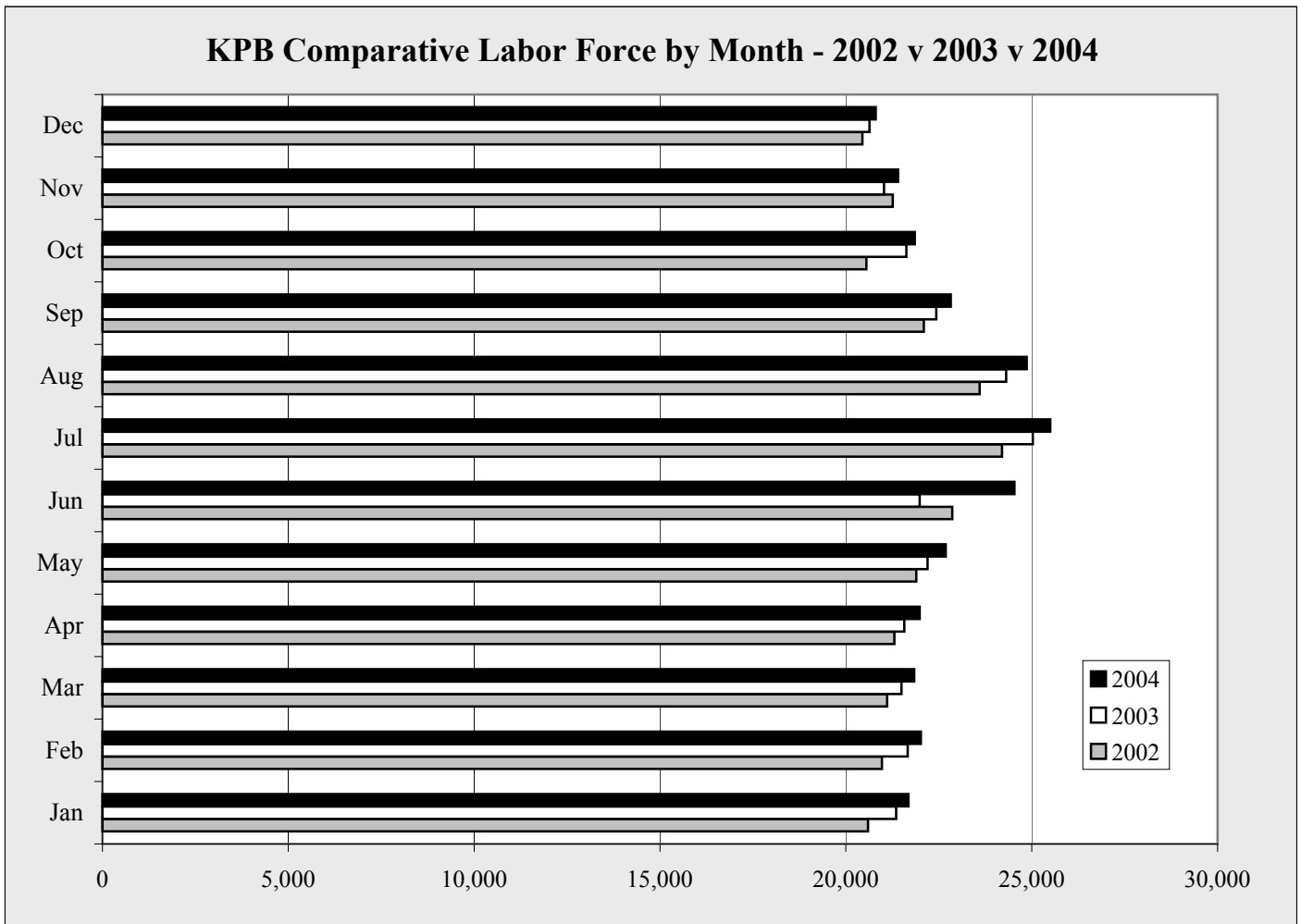

Chart 1.37

KPB Employment

KPB Unemployment by Month - 1990-2004

	Jan	Feb	Mar	Apr	May	Jun	Jul	Aug	Sep	Oct	Nov	Dec	Avg
1990	2,684	2,671	2,451	2,321	2,117	1,969	1,651	1,733	1,925	2,384	2,331	2,311	2,212
1991	2,894	2,960	2,769	2,635	2,383	2,381	2,179	2,045	2,203	2,900	3,398	3,523	2,689
1992	4,173	4,388	3,776	3,435	3,081	3,050	2,510	2,004	2,233	2,971	2,983	3,056	3,138
1993	3,644	3,816	3,341	3,084	2,594	2,483	1,949	1,695	1,724	2,507	2,641	2,686	2,680
1994	3,397	3,634	3,282	2,933	2,617	2,516	2,390	1,920	1,819	2,688	2,546	2,753	2,708
1995	3,589	3,623	3,143	2,650	2,238	2,238	2,137	1,863	1,864	2,717	2,807	2,966	2,653
1996	3,749	3,987	3,409	3,163	2,939	2,768	2,555	2,145	2,651	3,293	3,578	3,524	3,147
1997	4,456	4,487	3,849	3,369	2,778	2,814	2,390	1,984	2,093	2,706	2,775	2,667	3,031
1998	3,009	2,973	2,531	2,141	1,855	2,075	1,657	1,371	1,630	2,062	1,994	2,092	2,116
1999	2,921	3,445	2,897	2,519	2,229	2,256	1,994	1,742	1,885	2,198	2,252	2,197	2,378
2000	3,249	3,270	2,843	2,424	1,970	1,643	1,709	1,634	1,458	1,911	2,053	2,254	2,202
2001	2,810	2,862	2,526	2,157	1,829	1,726	1,746	1,570	1,714	1,950	2,066	2,316	2,106
2002	2,978	3,057	2,932	2,568	2,380	2,162	2,288	2,148	2,397	2,735	2,614	3,001	2,605
2003	3,430	3,477	2,900	2,692	2,355	2,534	2,462	2,282	2,361	2,482	2,555	2,858	2,699
2004	3,264	3,243	2,793	2,534	2,210	2,277	2,166	2,034	2,160	2,107	2,222	2,465	2,456

Table 1.42

KPB Comparative Unemployment by Month - 2002 v 2003 v 2004

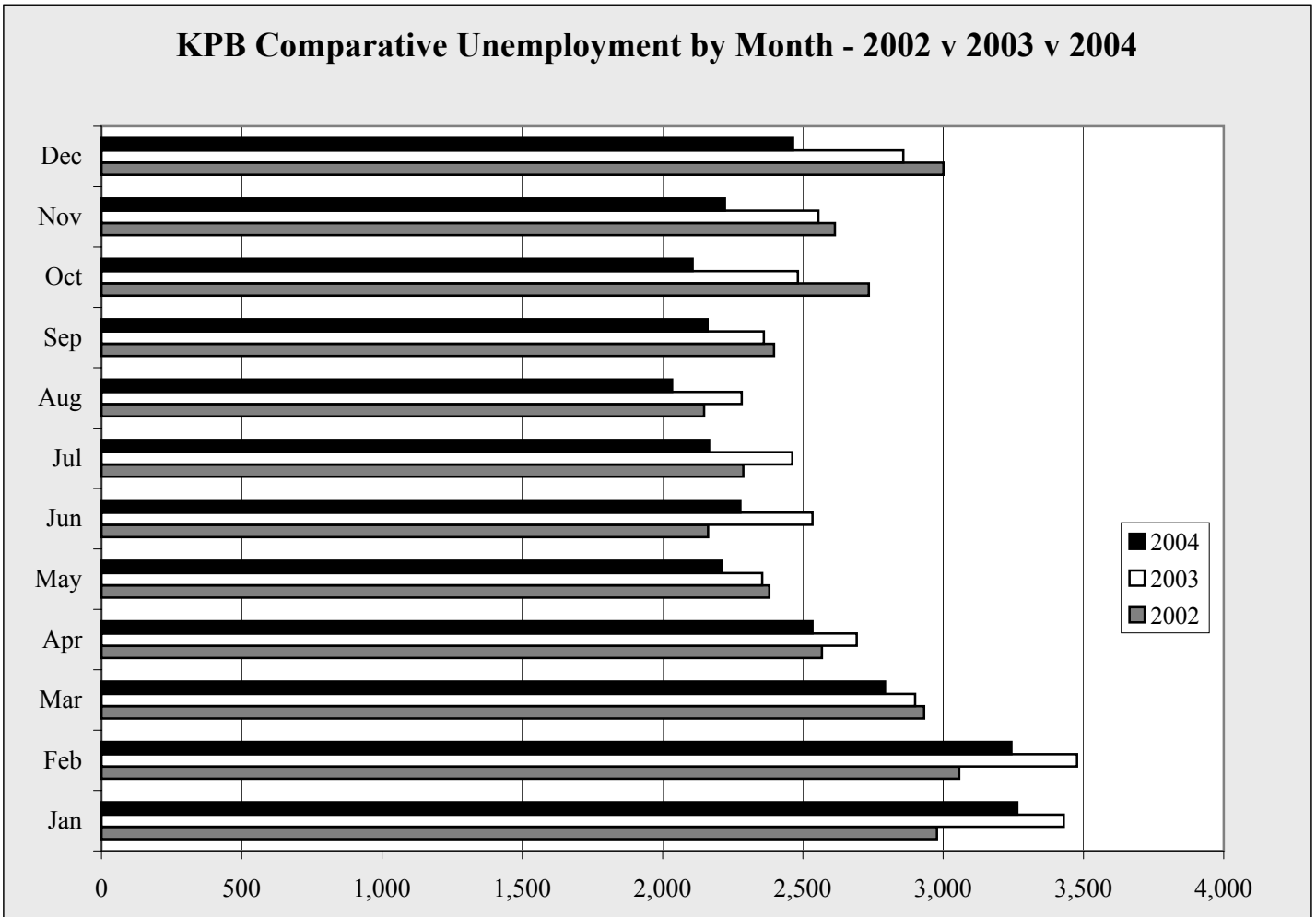

Chart 1.38

KPB Employment

KPB Unemployment Rates by Month - 1990-2004													
	Jan	Feb	Mar	Apr	May	Jun	Jul	Aug	Sep	Oct	Nov	Dec	Avg
1990	15.4%	15.0%	13.7%	12.5%	11.0%	9.7%	7.7%	8.3%	10.3%	12.8%	12.9%	13.0%	11.9%
1991	15.8%	15.9%	14.8%	13.5%	12.0%	11.4%	9.7%	9.5%	11.0%	15.2%	18.0%	19.0%	13.8%
1992	22.3%	22.5%	19.5%	17.4%	15.2%	13.7%	11.0%	9.4%	10.8%	14.6%	15.4%	16.0%	15.7%
1993	19.7%	19.6%	16.9%	15.3%	12.7%	10.9%	8.1%	7.4%	8.4%	12.2%	13.3%	13.9%	13.2%
1994	17.3%	17.2%	15.5%	14.3%	12.4%	10.8%	9.7%	8.2%	8.6%	12.8%	12.7%	14.2%	12.8%
1995	17.4%	17.1%	15.0%	12.9%	10.6%	9.8%	8.8%	7.9%	8.6%	12.7%	13.7%	14.9%	12.5%
1996	17.9%	18.3%	15.7%	14.6%	13.0%	11.5%	10.0%	8.6%	11.4%	15.0%	16.8%	17.1%	14.2%
1997	20.5%	20.0%	17.6%	15.3%	12.6%	11.6%	9.4%	8.1%	9.3%	12.7%	13.5%	13.4%	13.7%
1998	14.6%	14.4%	12.4%	10.5%	8.7%	8.8%	6.7%	5.6%	7.2%	9.7%	9.9%	10.7%	9.9%
1999	14.3%	16.3%	13.8%	12.0%	10.4%	9.8%	8.3%	7.5%	8.5%	10.4%	11.1%	11.1%	11.1%
2000	15.4%	15.1%	13.3%	11.5%	9.0%	7.1%	7.0%	7.0%	6.8%	9.1%	10.1%	11.3%	10.2%
2001	13.6%	13.6%	12.1%	10.4%	8.5%	7.5%	7.0%	6.6%	7.8%	9.2%	10.1%	11.5%	9.8%
2002	14.5%	14.6%	13.9%	12.1%	10.9%	9.5%	9.5%	9.1%	10.8%	13.3%	12.3%	14.7%	12.1%
2003	16.1%	16.0%	13.5%	12.5%	10.6%	11.5%	9.8%	9.4%	10.5%	11.5%	12.2%	13.8%	12.3%
2004	15.1%	14.7%	12.8%	11.5%	9.7%	9.3%	8.5%	8.2%	9.5%	9.6%	10.4%	11.8%	10.9%

Table 1.43

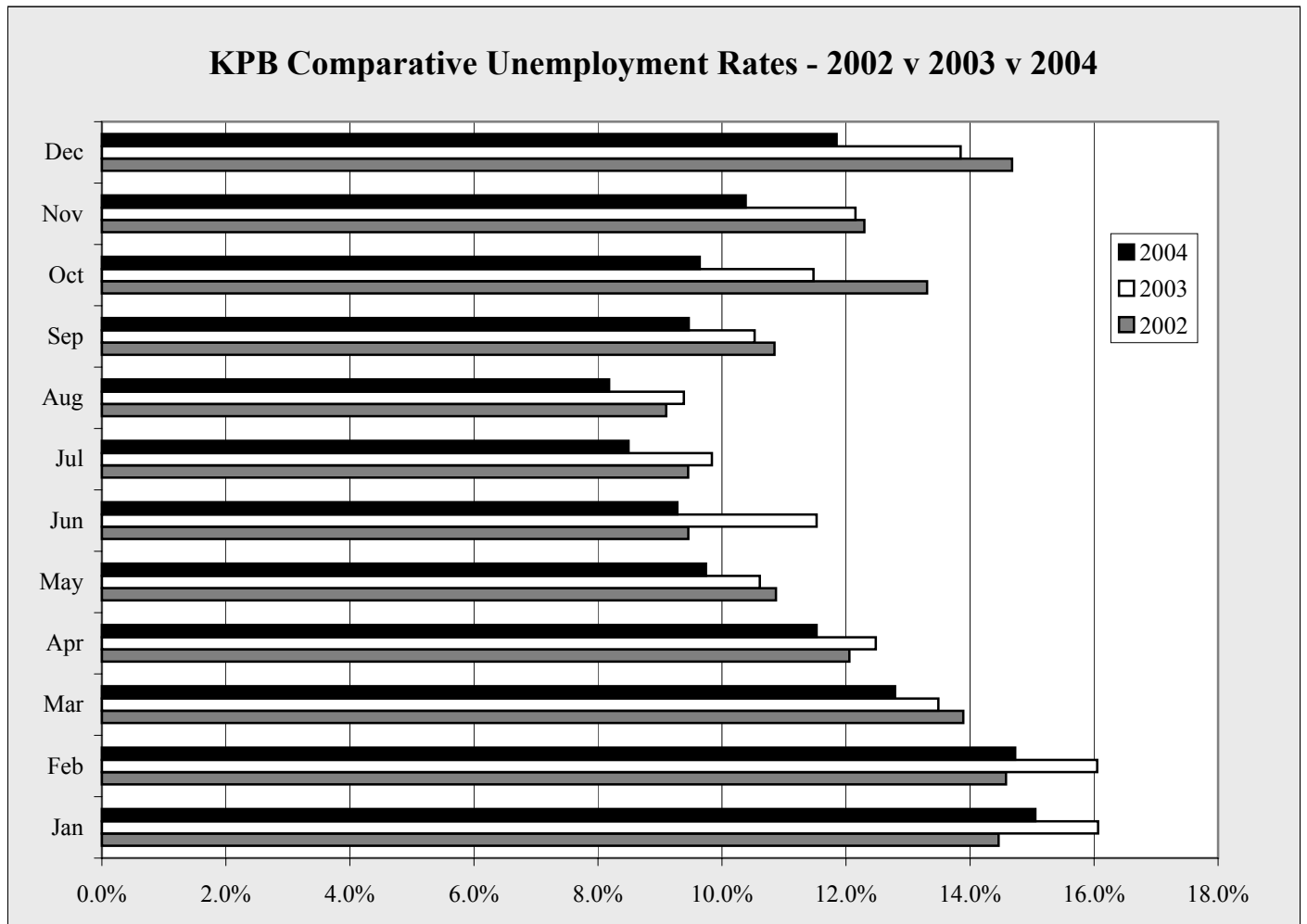

Chart 1.39

KPB Employment

KPB Employment by Month - 1990-2004													
	Jan	Feb	Mar	Apr	May	Jun	Jul	Aug	Sep	Oct	Nov	Dec	Avg
1990	14,800	15,163	15,456	16,241	17,046	18,312	19,846	19,262	16,707	16,208	15,756	15,496	16,691
1991	15,420	15,652	15,969	16,834	17,423	18,471	20,346	19,563	17,778	16,145	15,521	15,051	17,014
1992	14,576	15,080	15,590	16,299	17,137	19,156	20,256	19,405	18,381	17,329	16,426	16,082	17,143
1993	14,882	15,693	16,486	17,091	17,863	20,352	22,136	21,336	18,902	18,043	17,151	16,607	18,045
1994	16,205	17,470	17,911	17,624	18,429	20,747	22,221	21,452	19,259	18,234	17,511	16,639	18,642
1995	17,014	17,556	17,828	17,855	18,862	20,502	22,203	21,635	19,695	28,715	17,634	16,949	19,704
1996	17,153	17,808	18,330	18,446	19,712	21,232	23,028	22,696	20,577	18,613	17,757	17,037	19,366
1997	17,286	17,934	18,049	18,624	19,298	21,394	23,090	22,430	20,374	18,619	17,814	17,286	19,350
1998	17,668	17,740	17,895	18,254	19,491	21,400	23,116	22,948	20,937	19,146	18,118	17,428	19,512
1999	17,508	17,726	18,035	18,529	19,237	20,820	22,120	21,639	20,359	18,898	17,950	17,530	19,196
2000	17,875	18,432	18,477	18,737	19,880	21,492	22,589	21,785	20,126	19,108	18,207	17,733	19,537
2001	17,842	18,440	18,598	18,923	19,850	21,194	23,080	22,196	20,437	19,466	18,437	17,905	19,697
2002	17,618	17,912	18,176	18,737	19,513	20,701	21,913	21,453	19,702	17,819	18,647	17,445	19,136
2003	17,922	18,187	18,597	18,880	19,842	19,452	22,567	22,032	20,071	19,146	18,471	17,779	19,412
2004	18,420	18,775	19,044	19,452	20,477	22,258	23,335	22,833	20,663	19,749	19,182	18,338	20,211

Table 1.44

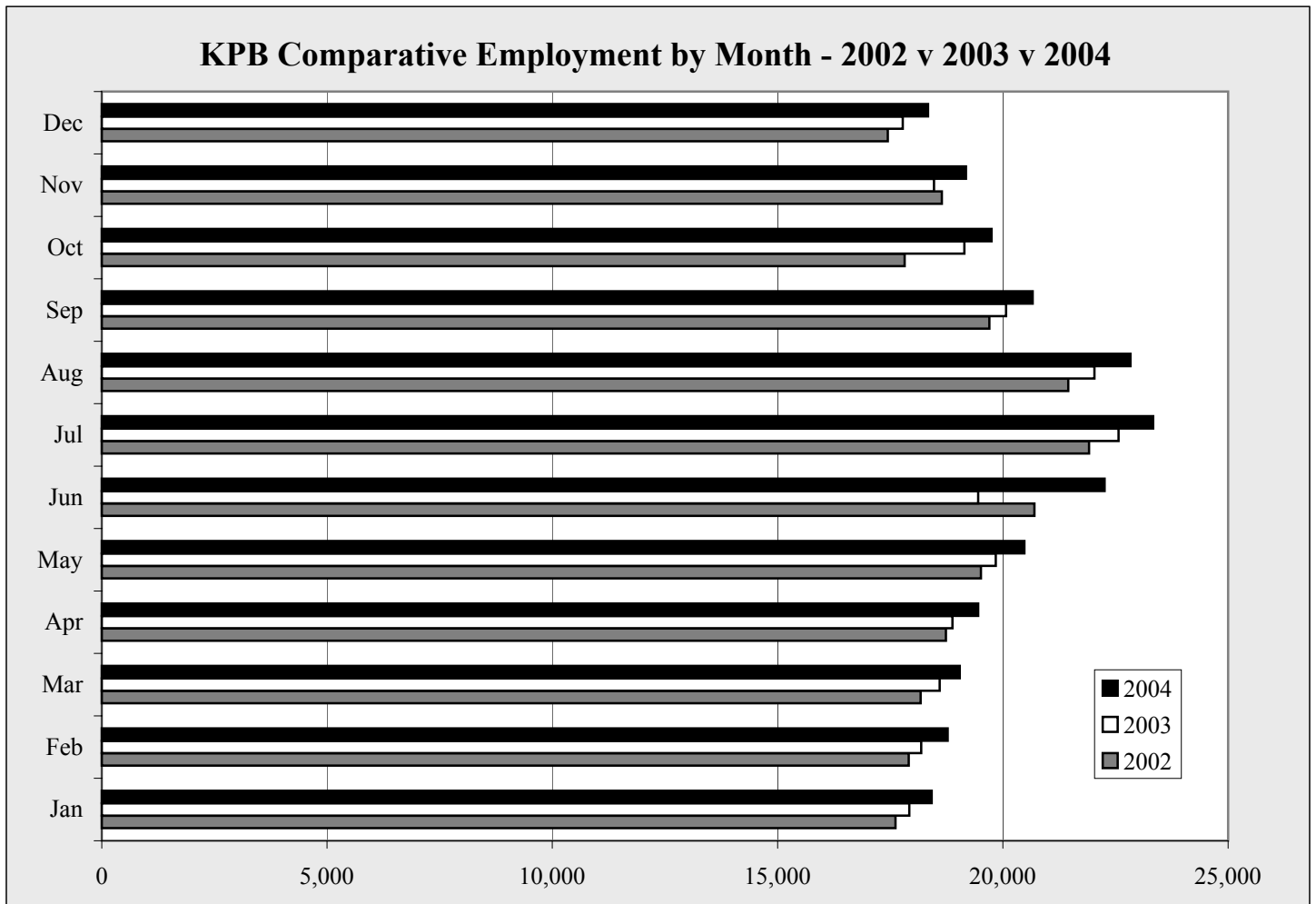

Chart 1.40

KPB Population

KPB CDP's Population Estimates - 2000 - 2004						
KPB Community	2000 Census	June 1 Estimate (Subject to Annual Revision)				Annual Change
		2001	2002	2003	2004	
Anchor Point	1,845	1,809	1,784	1,812	1,792	-1.1%
Bear Creek	1,748	1,836	1,832	1,835	1,897	3.4%
Beluga	32	24	25	27	26	-3.7%
Clam Gulch	173	168	173	176	164	-6.8%
Cohoe	1,168	1,175	1,209	1,206	1,312	8.8%
Cooper Landing	369	391	372	358	351	-2.0%
Crown Point	75	89	88	78	89	14.1%
Diamond Ridge*	1,802	1,812	404	306	761	148.7%
Fox River	616	594	574	572	587	2.6%
Fritz Creek	1,603	1,662	1,735	1,744	1,732	-0.7%
Funny River	636	624	688	707	727	2.8%
Halibut Cove	35	29	28	27	26	-3.7%
Happy Valley	489	505	521	505	525	4.0%
Homer*	3,946	4,065	5,527	5,865	5,332	-9.1%
Hope	137	145	152	161	165	2.5%
Jakolof Bay	Discontinued due to low count					
Kachemak	431	426	433	478	475	-0.6%
Kalifornsky	5,846	6,011	6,153	6,249	6,617	5.9%
Kasilof	471	451	504	568	473	-16.7%
Kenai	6,942	6,870	7,071	7,123	6,809	-4.4%
Lowell Point	92	96	108	89	74	-16.9%
Miller Landing*	74	70				
Moose Pass	206	206	217	221	220	-0.5%
Nanwalek	177	184	219	214	203	-5.1%
Nikiski	4,327	4,362	4,360	4,356	4,279	-1.8%
Nikolaevsk	345	345	331	312	306	-1.9%
Ninilchik	772	758	760	774	783	1.2%
Port Graham	171	178	174	165	153	-7.3%
Primrose	93	98	92	86	90	4.7%
Ridgeway	1,932	1,961	1,963	2,022	2,047	1.2%
Salamatof	954	894	897	904	900	-0.4%
Seldovia**	430	435	450	431	426	-1.2%
Seldovia City**	286	285	288	279	263	-5.7%
Seldovia Village**	144	150	166	155	170	9.7%
Seward	2,830	2,759	2,754	2,745	2,540	-7.5%
Soldotna	3,759	3,791	3,856	3,992	3,767	-5.6%
Sterling	4,705	4,753	4,771	4,880	4,940	1.2%
Sunrise	18	16	14	15	19	26.7%
Tyonek	193	161	181	192	184	-4.2%
Remainder						
Kenai/Cook Inlet		229	188	190	181	-4.7%
Remainder Seward census sub area		23	13	13	8	-38.5%
Remainder of KPB	249					
Kenai Peninsula	49,691	50,005	50,621	51,398	50,980	-0.8%

Table 1.45

* - Homer annexation included all of Miller Landing CDP and part of Diamond Ridge CDP. Annexation was effective March 20, 2002.

** - Seldovia City plus Seldovia Village is not equal to the Seldovia CDP.

Note - All Estimates since 2000 have been revised by the State of Alaska Department of Labor and Workforce Development.

KPB Population

KPB Community	KPB Region	Census							10 Year Change
		1940	1950	1960	1970	1980	1990	2000	
Anchor Point	S	20	65	171	102	226	866	1,845	113.0%
Grouse Creek	E	New					580	1,748	201.4%
Beluga	W	New						32	NA
Clam Gulch	C	0			47	50	79	173	119.0%
Cohoe	C	0	0	122	0	0	508	1,168	129.9%
Cooper Landing	S	0	60	130	31	116	243	369	51.9%
Crown Point	E	0					62	75	21.0%
Diamond Ridge	S	New						1,802	NA
Fox River	S	0	0	0	0	0	382	616	61.3%
Fritz Creek	S	0	0	0	27	404	1,426	1,603	12.4%
Funny River	C	New						636	NA
Halibut Cove	S	0		25	44	47	78	35	-55.1%
Happy Valley	S	0					309	489	58.3%
Homer	S	325	307	1,247	1,803	2,209	3,660	3,946	7.8%
Hope	E	71	63	44	51	103	161	137	-14.9%
Jakolof Bay	S	0				36	28	Discontinued	NA
Kachemak	S	0			76	301	365	431	18.1%
Kalifornsky	C	0				92	285	5,846	1951.2%
Kasilof	C	62	62	89	71	201	383	471	23.0%
Kenai	C	303	321	778	3,533	4,324	6,327	6,942	9.7%
Lowell Point	E	New						92	NA
Miller Landing	S	New						74	NA
Moose Pass	E	84	70	136	53	76	81	206	154.3%
Nanwalek	S	48	75	78	58	124	158	177	12.0%
Nikiski	C	0				1,109	2,743	4,327	57.7%
Nikolaevsk	S	0				0	371	345	-7.0%
Ninilchik	S	132	97	169	134	341	456	772	69.3%
Port Graham	S	93	92	139	107	161	166	171	3.0%
Primrose	E	0					63	93	47.6%
Ridgeway	C	0					2,018	1,932	-4.3%
Salamatof	C	0				334	999	954	-4.5%
Seldovia Village	S	410	437	460	437	479	459	144	-68.6%
Seldovia City	S	0					316	286	-9.5%
Seward	E	949	2,114	1,891	1,587	1,843	2,699	2,830	4.9%
Soldotna	C	0		32	1,202	2,320	3,482	3,759	8.0%
Sterling	C	0		115	30	919	3,802	4,705	23.8%
Sunrise	C	New						18	NA
Tyonek	W	136	132	187	232	239	154	193	25.3%
Remainder of Census area	E			2,956	2,337	9,228	7,409	249	-96.6%
Kenai Peninsula Borough		2,633	3,895	8,769	11,962	25,282	40,802	49,691	21.8%

Table 1.46

KPB Population

Select Census 2000 Detail of KPB Cities and Largest CDP's

	KPB	Homer	Kalifornsky	Kenai	Nikiski	Seldovia City	Seward	Soldotna	Sterling
Population	49,691	3,946	5,846	6,942	4,327	286	2,830	3,759	4,705
Male - Percent of Total	52.0%	49.4%	51.8%	49.4%	52.2%	50.7%	60.0%	47.6%	52.0%
Female - Percent of Total	48.0%	50.6%	48.2%	50.6%	47.8%	49.3%	40.0%	52.4%	48.0%
Median Age	36.3	38.8	35.2	32.3	34.2	45.3	37.1	34.9	36.4
Persons Under 5 Years of Age	3,288	254	388	554	298	15	164	269	297
Percent Of Persons Under 5 Years of Age	6.6%	6.4%	6.6%	8.0%	6.9%	5.2%	5.8%	7.2%	6.3%
Persons Over 65 Years of Age	3,649	398	318	443	256	37	211	369	314
Percent of Persons Over 65 Years of Age	7.3%	10.1%	5.4%	6.4%	5.9%	12.9%	7.5%	9.8%	6.7%
Total Households	18,438	1,599	2,117	2,622	1,514	134	917	1,465	1,676
Average Household Size	2.62	2.40	2.74	2.64	2.86	2.13	2.40	2.53	2.80
Total Families	12,716	1,009	1,597	1,787	1,131	71	556	970	1,306
Average Family Size	3.15	2.99	3.13	3.20	3.31	2.93	3.04	3.13	3.16
Female Householder, no husband present, children under 18 - Percent	6.9%	7.7%	6.2%	10.0%	6.1%	6.0%	9.5%	10.9%	4.7%
Rental Vacancy Rate - Percent	14.4%	10.9%	13.8%	17.9%	15.4%	24.5%	8.4%	15.4%	14.9%
Percent of Population Race = White Only	86.2%	90.5%	89.8%	82.8%	87.2%	73.4%	72.1%	88.1%	92.7%
Percent High School Graduates or Higher	88.5%	92.4%	90.3%	88.3%	88.5%	86.4%	86.7%	87.6%	89.2%
Percent with Bachelor's Degrees or Higher	20.3%	29.2%	22.2%	16.0%	16.8%	21.0%	15.9%	15.5%	17.8%
Percent with Graduate or Professional Degree	6.7%	10.7%	8.3%	4.9%	4.3%	4.7%	5.8%	6.0%	5.3%
Never Married, over 15 - percent	23.4%	23.4%	22.1%	23.5%	22.8%	20.4%	31.6%	22.5%	21.2%
Now married, not separated, over 15 - percent	58.4%	56.1%	61.1%	55.8%	59.5%	56.6%	46.5%	54.7%	65.9%
Divorced, over 15 - percent	12.8%	14.9%	12.5%	14.7%	12.5%	20.9%	14.9%	13.8%	9.5%
Civilian veterans - over 18	17.1%	16.4%	16.4%	16.7%	15.0%	21.7%	18.5%	15.7%	18.0%
Population age 21-64 with disability - percent	17.0%	16.1%	14.2%	14.9%	20.7%	19.3%	19.2%	20.8%	15.9%
Residence same house as 1995 - percent	53.8%	47.5%	52.0%	42.6%	64.6%	68.0%	47.5%	49.5%	58.8%
Median Household Income	\$46,397	\$42,821	\$54,865	\$45,962	\$51,176	\$45,313	\$44,306	\$48,420	\$47,700
Median Family Income	\$54,106	\$53,571	\$58,750	\$56,856	\$55,969	\$58,000	\$54,904	\$52,372	\$53,889
Family Income less than \$10,000	4.7%	4.6%	4.4%	4.8%	5.9%	NA	5.2%	3.5%	4.9%
Family Income greater than \$200,000	1.6%	1.9%	2.5%	0.8%	0.5%	NA	1.6%	2.7%	1.0%
Per Capita Income	\$20,949	\$21,823	\$23,898	\$20,789	\$20,129	\$23,669	\$20,360	\$21,740	\$20,741
Median Earnings - Male, Full-time, Year-Around	\$44,106	\$38,062	\$50,583	\$48,371	\$50,673	\$41,250	\$36,900	\$43,162	\$45,062
Median Earnings - Female, Full-time, Year-Around	\$28,107	\$30,494	\$30,493	\$27,112	\$26,779	\$33,750	\$30,508	\$24,598	\$27,946
Percent Population With Retirement Income	15.5%	16.9%	13.6%	11.2%	18.9%	18.6%	15.9%	17.6%	14.5%
Percent Population With Public Assistance Income	10.2%	8.5%	8.7%	15.8%	11.6%	5.4%	11.4%	11.8%	11.9%
Percent Over 16 in Labor Force	62.8%	67.3%	64.0%	66.0%	61.7%	61.8%	53.6%	69.3%	62.0%
Average Travel Time to Work In Minutes	25.6	17.9	31.1	21.1	30.2	15.5	9.9	18.8	32.6
Private wage and salary workers - percent	67.2%	63.9%	70.9%	74.1%	70.1%	59.7%	61.6%	75.0%	71.7%
Government workers - percent	19.5%	16.9%	20.6%	19.9%	15.3%	17.1%	27.9%	17.8%	15.8%
Self-employed, non incorporated business	12.7%	18.6%	7.9%	6.0%	13.9%	20.9%	10.0%	6.6%	12.1%
Families in Poverty - percent	7.6%	7.7%	6.6%	8.2%	9.3%	3.0%	8.3%	5.8%	7.7%
Of families in Poverty, female householder, no husband present, children under 18	28.0%	29.8%	22.9%	33.6%	33.8%	22.2%	35.2%	17.3%	32.4%
Individuals in poverty - percent	10.0%	9.3%	7.9%	9.8%	11.4%	7.9%	10.6%	6.6%	10.0%
Median Owner Occupied Home Value	\$118,000	\$131,600	\$124,600	\$112,400	\$111,700	\$80,000	\$132,300	\$111,600	\$120,100
Median Monthly Mortgage/Owner Costs	\$1,054	\$1,176	\$1,085	\$993	\$1,081	\$788	\$1,194	\$998	\$1,009
Median Rent	\$609	\$638	\$606	\$604	\$631	\$344	\$580	\$605	\$628

Table 1.47

KPB Population

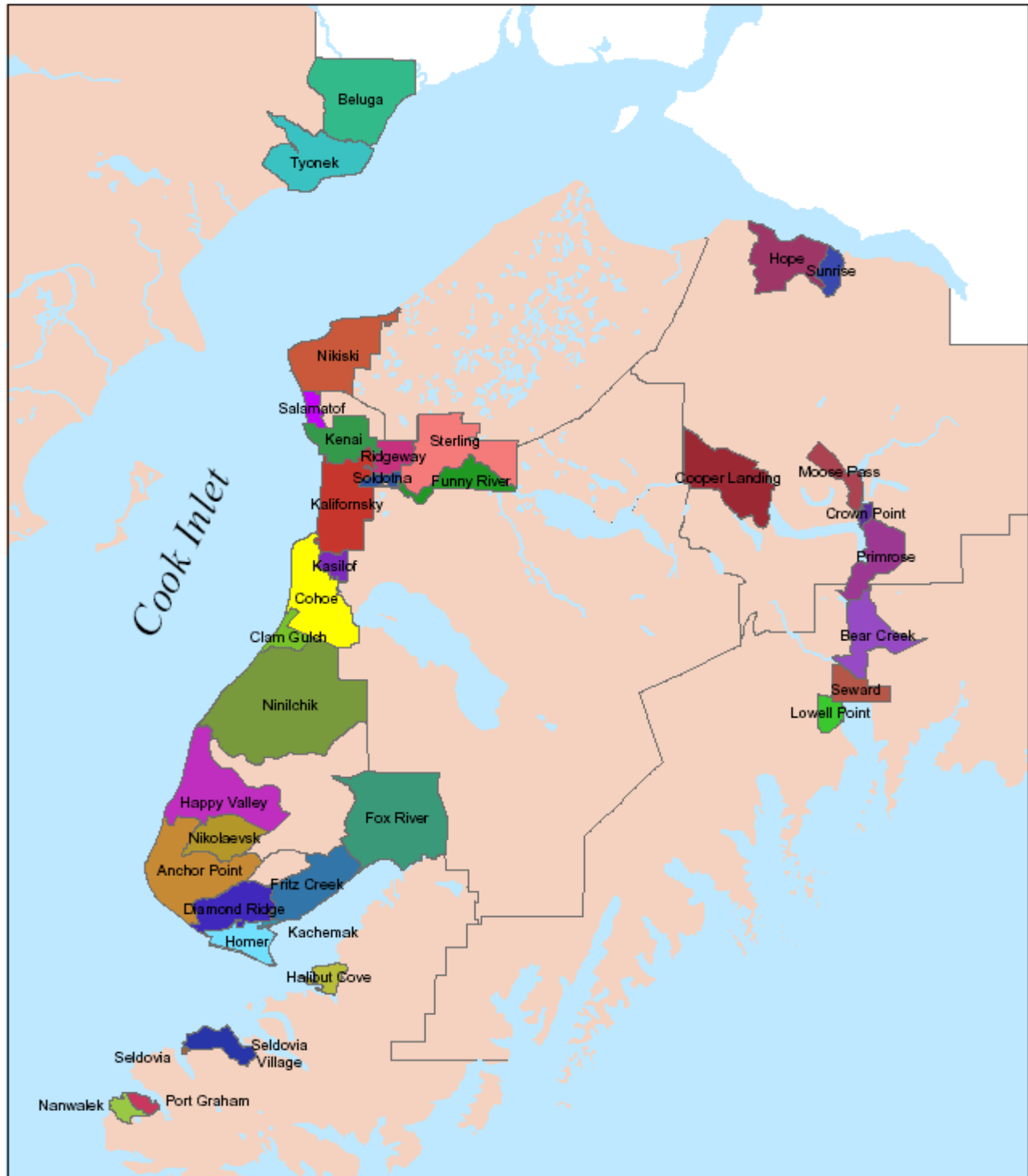

KENAI PENINSULA BOROUGH CENSUS DESIGNATED PLACES

KPB Population

KPB Population by Age Group - 1990 v 2000

	1990	2000	Percent Change	Percent of Total Population
Total Population	40,802	49,691	21.8%	
Under 5 years	3,862	3,288	-14.9%	6.6%
5 to 9 years	4,059	4,024	-0.9%	8.1%
10 to 14 years	3,516	4,698	33.6%	9.5%
15 to 19 years	2,970	4,140	39.4%	8.3%
20 to 24 years	2,081	2,132	2.5%	4.3%
25 to 34 years	7,348	5,648	-23.1%	11.4%
35 to 44 years	8,234	9,074	10.2%	18.3%
45 to 54 years	4,205	8,739	107.8%	17.6%
55 to 59 years	1,376	2,632	91.3%	5.3%
60 to 64 years	1,164	1,667	43.2%	3.4%
65 to 74 years	1,489	2,361	58.6%	4.8%
75 to 84 years	419	1,077	157.0%	2.2%
85 years and over	79	211	167.1%	0.4%

Table 1.48

KPB's median age increased from 31.1 years during the 1990 census to 36.3 as of Census 2000. Alaska's median age is 32.4 years while the United States median age is 35.3 years.

KPB's 2003 population, estimated by the AK DOL&WD is estimated at 51,220, a 0.1% increase over 2002.

Estimates are based primarily on births, deaths and Permanent Fund Dividend applications.

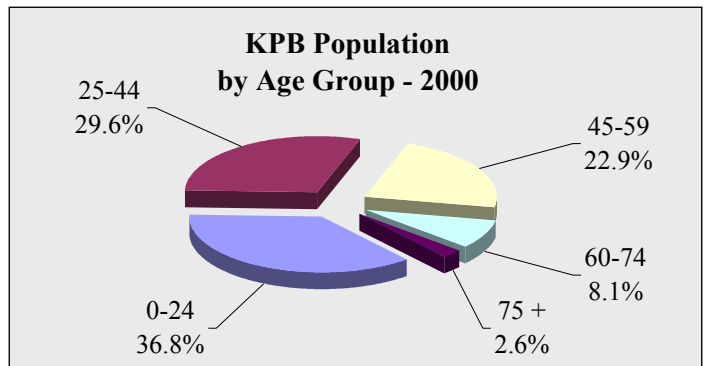

Chart 1.41

KPB Population by Age Group - 1990 v 2000

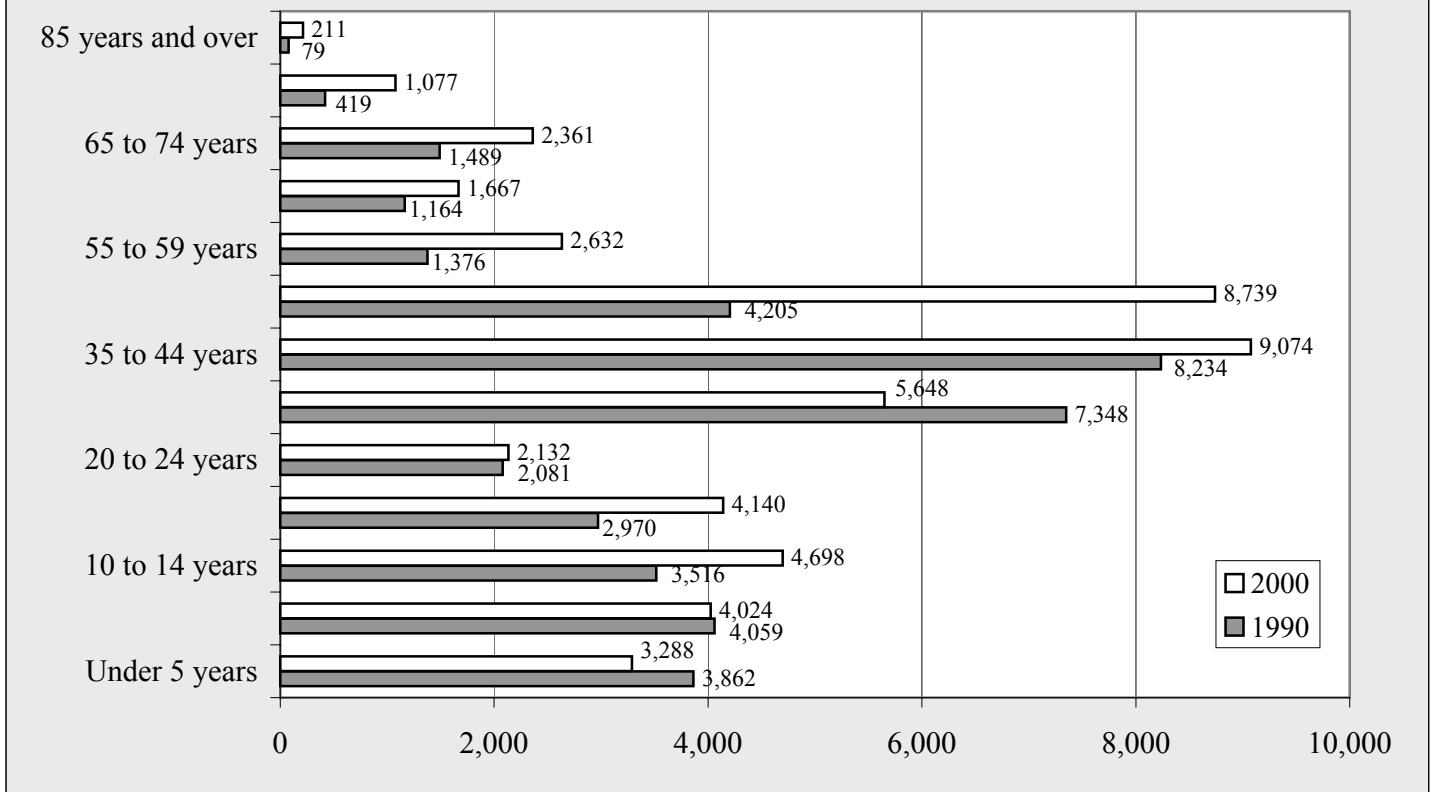

Chart 1.42

Homer Sales

Homer 4th Quarter GROSS Sales by Industry - 1998-2004 - in \$								
	1998	1999	2000	2001	2002	2003	2004	Annual Change
AFF	285,512	469,897	356,399	180,478	269,340	437,222	343,169	-21.5%
Min	130	0	1,117	629	0	835	150,116	NA
Const	8,120,674	8,424,403	10,008,082	11,585,650	13,988,424	9,401,489	12,644,345	34.5%
Manu	4,924,181	1,970,485	1,559,906	1,734,909	1,392,884	1,519,056	975,316	-35.8%
TCPU	8,323,199	8,039,318	8,228,869	10,477,076	9,846,186	9,421,507	11,303,224	20.0%
Whole	3,311,316	3,277,873	3,765,653	3,645,705	4,601,989	5,308,837	8,658,575	63.1%
Retail	14,700,690	15,006,104	16,380,328	17,741,385	20,507,272	21,948,278	22,683,275	3.3%
FIRE	1,916,911	1,647,073	1,588,898	1,879,041	2,182,789	2,573,322	3,964,014	54.0%
Service	5,217,004	5,229,365	6,340,055	7,302,225	7,779,624	9,573,598	11,343,028	18.5%
Total	46,799,617	44,064,518	48,229,307	54,547,098	60,568,508	60,184,144	72,065,062	19.7%
Annual Change		-5.8%	9.5%	13.1%	11.0%	-0.6%	19.7%	

Table 2.1

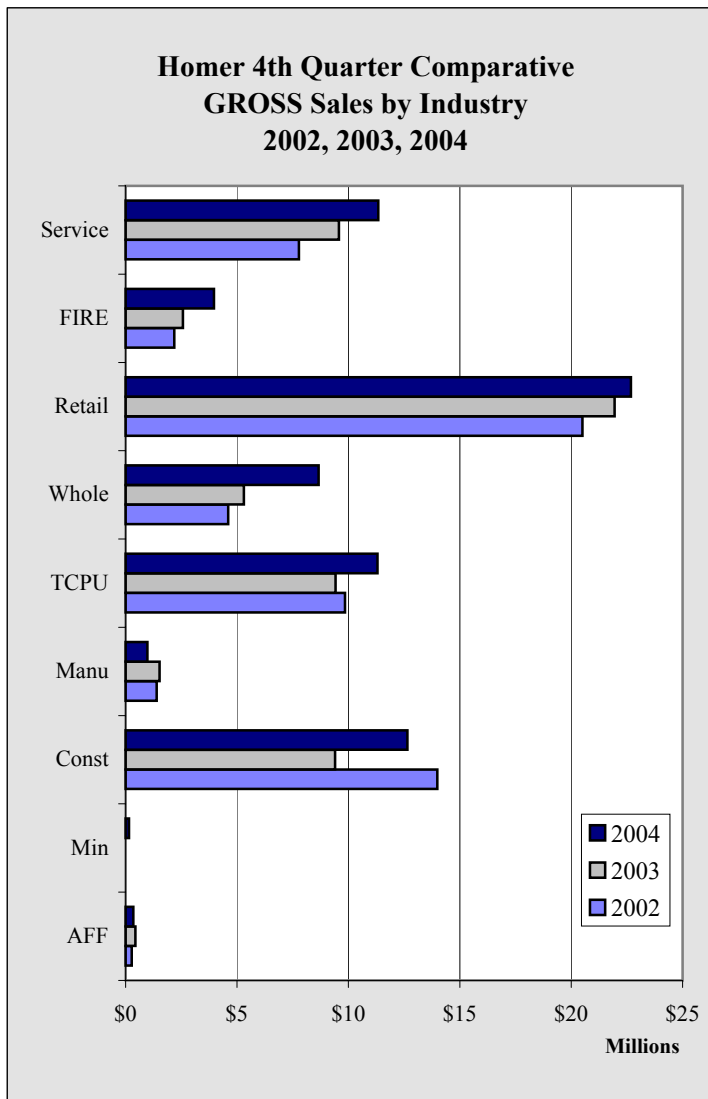

Chart 2.1

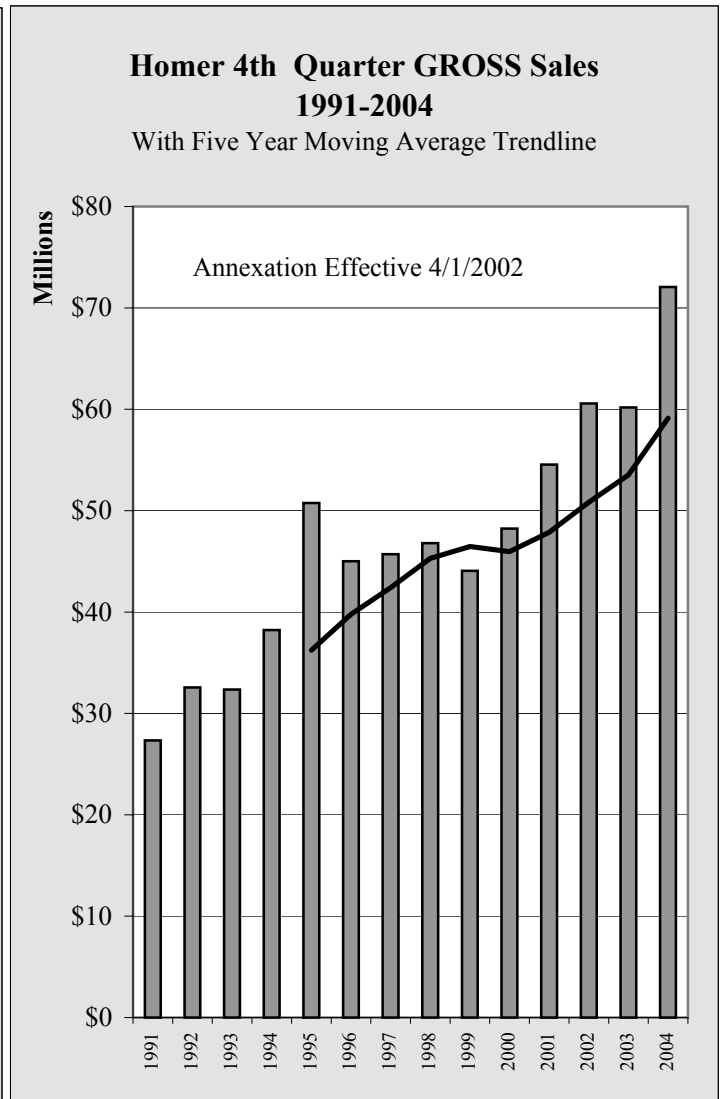

Chart 2.2

Homer Sales

Homer 4th Quarter TAXABLE Sales by Industry - 1998-2004 - in \$							
	1998	1999	2000	2001	2002	2003	2004
AFF	159,782	116,174	127,154	145,213	161,134	174,675	195,762
Min	130	0	604	629	0	347	0
Const	217,382	242,434	212,931	263,173	296,675	317,118	284,203
Manu	491,386	489,861	500,013	389,562	404,872	420,093	306,985
TCPU	2,168,344	2,265,334	2,222,158	2,244,804	2,847,193	2,860,937	2,675,515
Whole	1,639,482	1,836,907	1,752,226	1,839,573	1,767,769	2,263,324	1,876,182
Retail	10,843,732	11,296,848	11,734,973	12,338,158	14,208,287	15,420,014	15,575,201
FIRE	668,052	688,193	736,518	838,352	950,729	965,111	1,652,329
Service	3,364,627	3,388,232	4,100,596	3,720,692	4,415,755	4,649,854	4,705,847
Total	19,552,917	20,323,983	21,387,173	21,780,156	25,052,414	27,071,473	27,272,024
Annual Change		3.9%	5.2%	1.8%	15.0%	8.1%	0.7%

Table 2.2

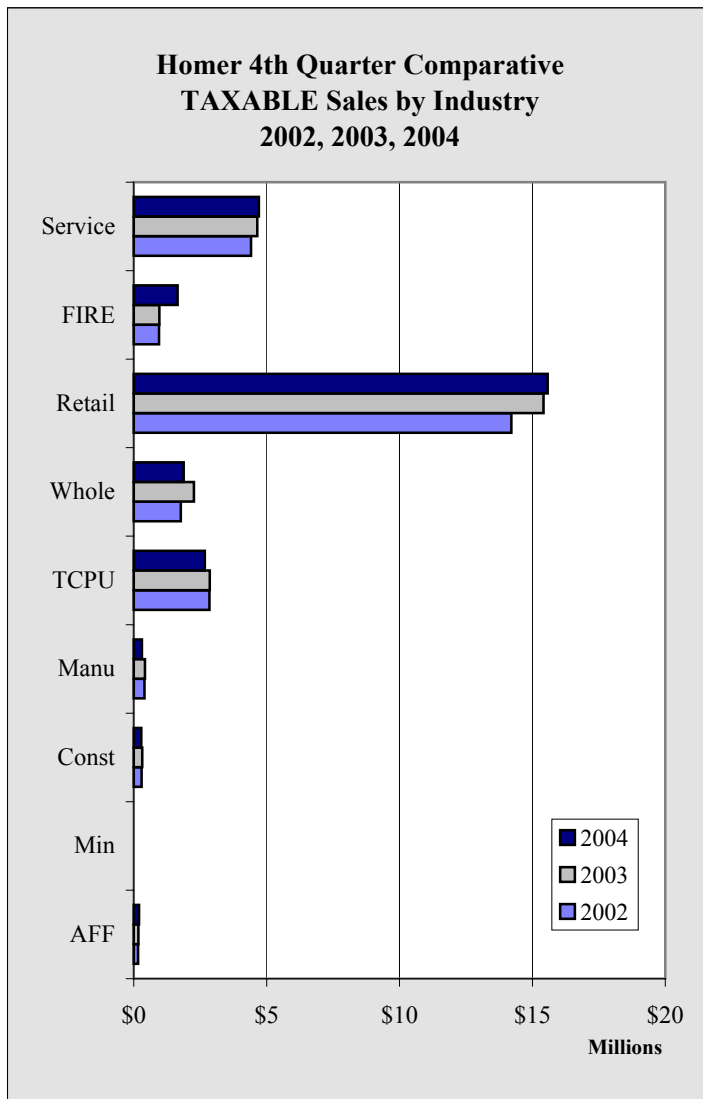

Chart 2.3

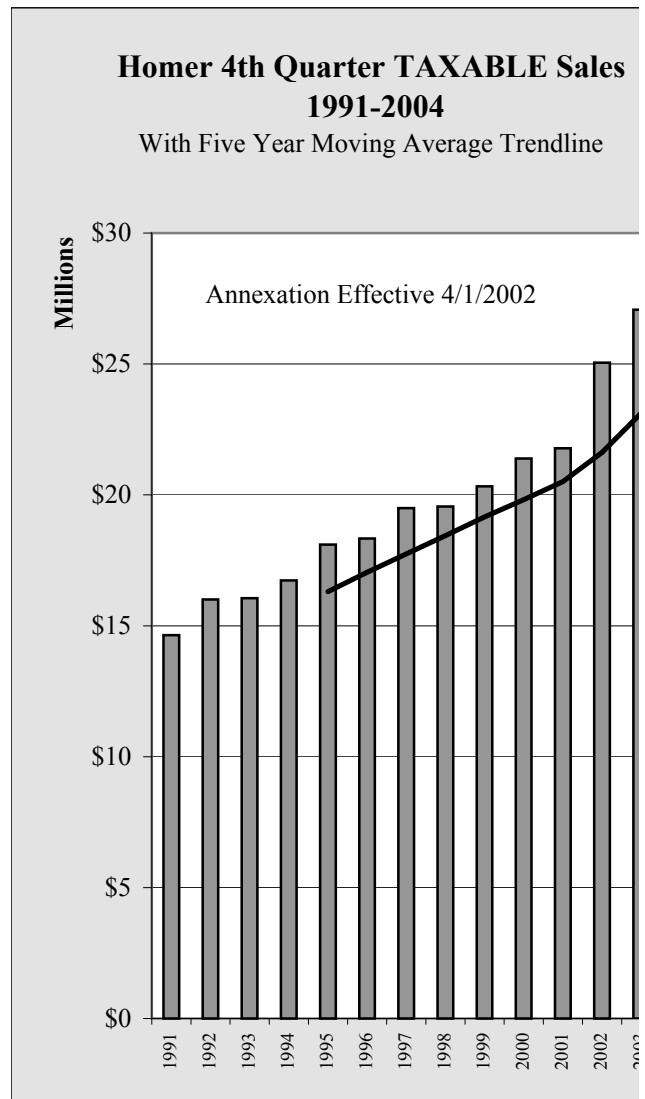
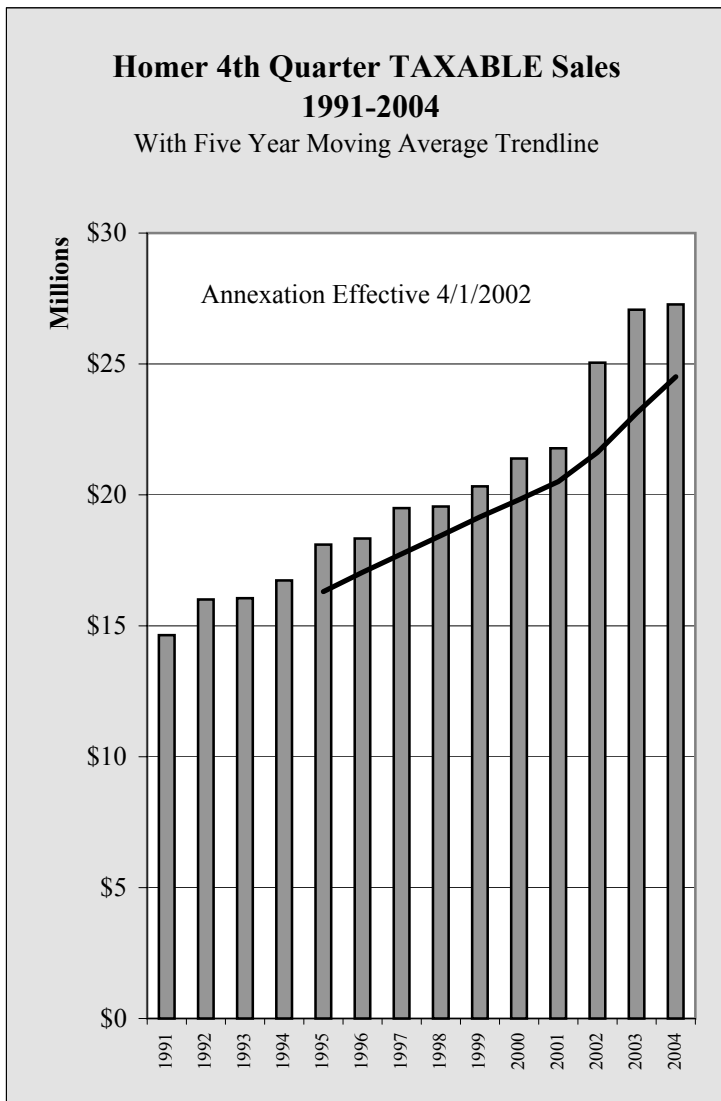

Chart 2.4

Homer Sales

Annual Change
12.1%
NA
-10.4%
-26.9%
-6.5%
-17.1%
1.0%
71.2%
1.2%
0.7%



Homer Sales

Homer Annual GROSS Sales by Industry - 1998-2004 - in \$

	1998	1999	2000	2001	2002	2003	2004	Annual Change
AFF	1,231,758	1,132,289	1,763,891	931,926	1,013,352	1,592,413	1,514,988	-4.9%
Min	130	13,595	24,864	15,819	8,582	1,283	151,171	11682.6%
Const	37,787,332	27,642,104	42,378,954	40,149,696	45,829,436	41,487,107	32,334,613	-22.1%
Manu	19,649,701	16,450,883	6,761,789	6,482,895	6,590,594	6,755,907	5,651,230	-16.4%
TCPU	34,491,856	33,675,536	34,493,682	40,495,596	42,137,752	39,996,686	40,282,208	0.7%
Whole	14,672,913	17,513,809	16,999,389	18,602,483	19,915,750	22,075,685	26,528,247	20.2%
Retail	64,712,270	66,221,369	71,465,479	75,795,576	88,239,711	97,820,663	105,311,298	7.7%
FIRE	8,574,588	7,448,936	6,682,678	7,544,432	8,453,334	9,936,484	12,172,423	22.5%
Service	31,322,069	33,743,954	35,410,998	39,685,084	51,007,289	53,756,598	60,265,648	12.1%
Govt	0	0	0	0	0	263	394	49.8%
Total	212,442,617	203,842,475	215,981,724	229,703,507	263,195,800	273,423,089	284,212,220	3.9%
Annual Change		-4.0%	6.0%	6.4%	14.6%	3.9%	3.9%	

Table 2.3

**Homer Annual Comparative
GROSS Sales by Industry
2002, 2003, 2004**

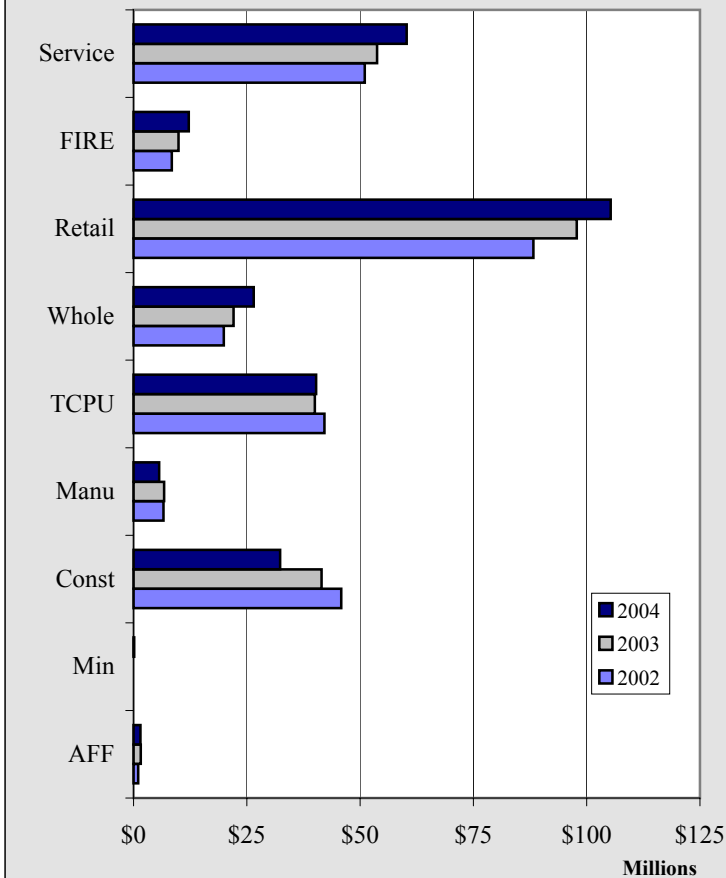

Chart 2.5

**Homer Annual GROSS Sales
1991-2004**

With Five Year Moving Average Trendline

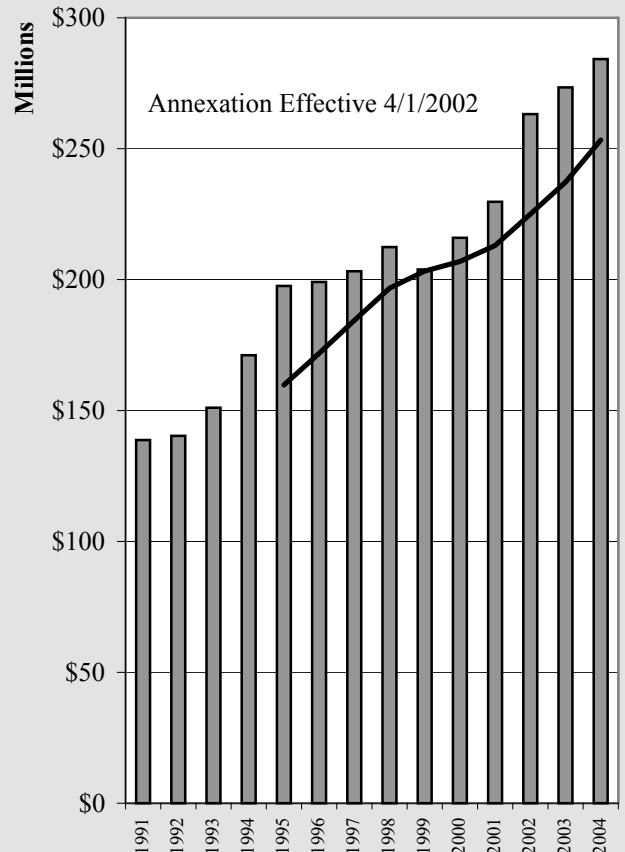

Chart 2.6

Homer Sales

Homer Annual TAXABLE Sales by Industry - 1998-2004 - in \$								
	1998	1999	2000	2001	2002	2003	2004	Annual Change
AFF	626,058	461,892	519,595	577,360	641,294	773,421	907,331	17.3%
Min	130	195	1,104	5,993	2,665	347	104	NA
Const	820,655	891,101	891,188	940,211	1,125,715	1,200,409	1,181,386	-1.6%
Manu	2,087,103	2,084,079	2,045,894	1,769,534	1,822,345	1,848,166	1,852,418	0.2%
TCPU	9,578,082	10,137,988	10,110,454	10,200,922	11,698,087	12,717,059	12,640,150	-0.6%
Whole	7,485,103	8,034,552	8,633,107	8,953,325	8,876,648	10,611,085	11,429,493	7.7%
Retail	48,994,370	50,357,048	53,206,860	56,027,806	63,864,887	69,823,667	73,962,665	5.9%
FIRE	2,814,367	2,949,461	3,147,793	3,460,712	3,890,685	4,074,657	5,150,409	26.4%
Service	22,035,474	23,232,422	24,634,121	25,375,676	29,345,792	30,574,151	32,576,392	6.5%
Govt	0	0	0	0	0	263	394	49.8%
Total	94,441,342	98,148,738	103,190,116	107,311,539	121,268,118	131,623,225	139,700,742	6.1%
Annual Change		3.9%	5.1%	4.0%	13.0%	8.5%	6.1%	

Table 2.4

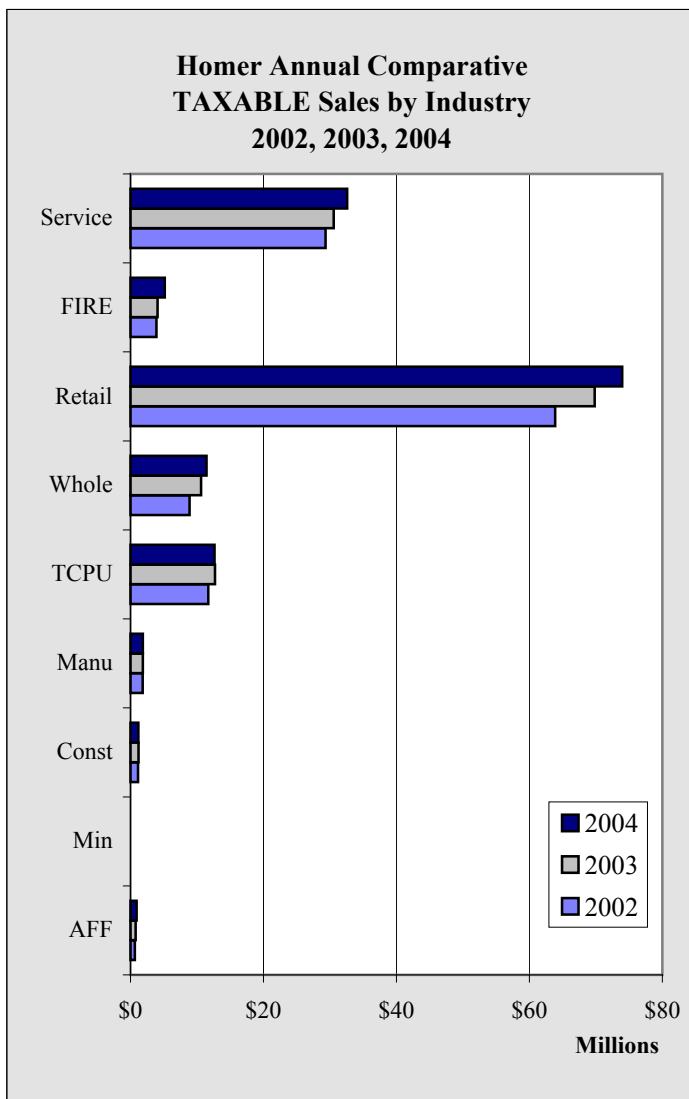

Chart 2.7

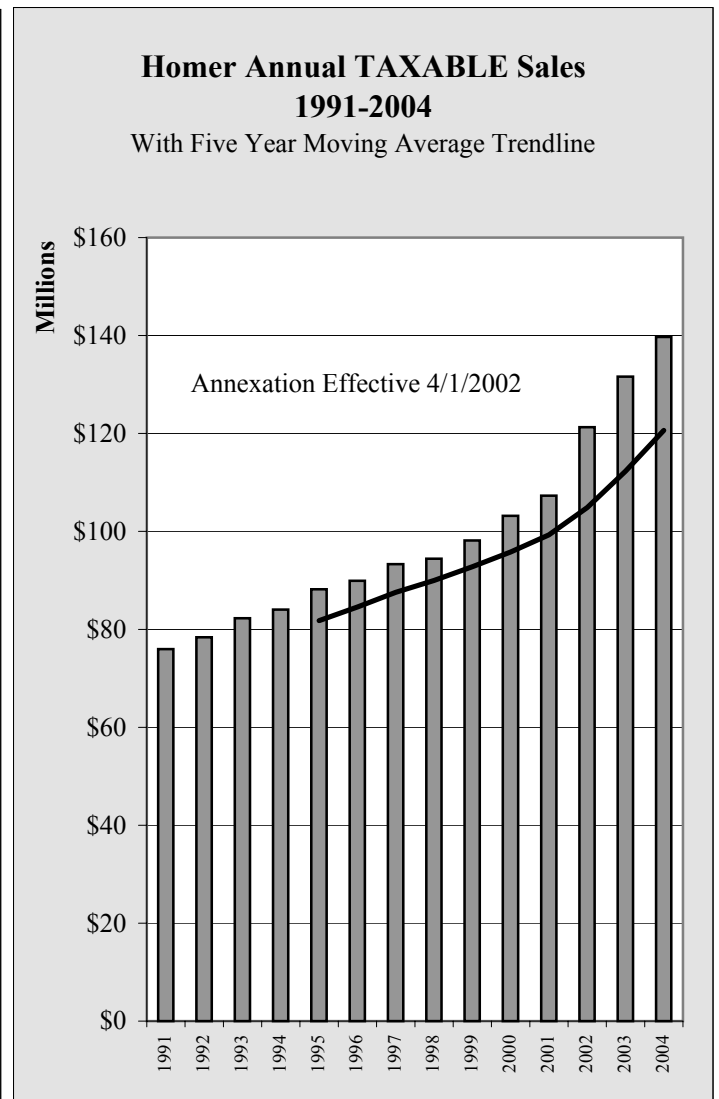

Chart 2.8

Homer Sales

Homer GROSS Sales by Industry by Quarter - 2001 -2004 - in \$					
	1st Quarter	2nd Quarter	3rd Quarter	4th Quarter	Total
2001					
AFF	160,466	221,357	369,625	180,478	931,926
Min	9,137	1,844	4,209	629	15,819
Const	8,123,440	6,727,125	13,713,481	11,585,650	40,149,696
Manu	1,325,393	1,455,193	1,967,400	1,734,909	6,482,895
TCPU	8,393,207	8,926,617	12,698,696	10,477,076	40,495,596
Whole	3,500,654	5,204,028	6,252,096	3,645,705	18,602,483
Retail	12,926,124	20,975,149	24,152,918	17,741,385	75,795,576
FIRE	1,405,203	1,982,111	2,278,077	1,879,041	7,544,432
Service	5,001,354	11,364,051	16,017,454	7,302,225	39,685,084
Government	0	0	0	0	0
Total	40,844,978	56,857,475	77,453,956	54,547,098	229,703,507
2002					
AFF	134,712	250,389	358,911	269,340	1,013,352
Min	1,363	3,836	3,383	0	8,582
Const	8,430,924	7,437,731	15,972,357	13,988,424	45,829,436
Manu	1,253,834	1,790,421	2,153,455	1,392,884	6,590,594
TCPU	9,784,288	10,982,097	11,525,181	9,846,186	42,137,752
Whole	3,358,010	5,360,132	6,595,619	4,601,989	19,915,750
Retail	13,767,872	24,997,009	28,967,558	20,507,272	88,239,711
FIRE	1,527,725	2,046,589	2,696,231	2,182,789	8,453,334
Service	6,006,218	15,803,541	21,417,906	7,779,624	51,007,289
Government	0	0	0	0	0
Total	44,264,946	68,671,745	89,690,601	60,568,508	263,195,800
2003					
AFF	249,333	420,146	485,712	437,222	1,592,413
Min	0	0	448	835	1,283
Const	9,430,117	11,068,538	11,586,963	9,401,489	41,487,107
Manu	1,317,636	1,899,935	2,019,280	1,519,056	6,755,907
TCPU	9,460,657	9,778,534	11,335,988	9,421,507	39,996,686
Whole	4,044,595	6,092,813	6,629,440	5,308,837	22,075,685
Retail	17,108,705	27,557,784	31,205,896	21,948,278	97,820,663
FIRE	1,989,925	2,547,744	2,825,493	2,573,322	9,936,484
Service	7,248,822	15,895,126	21,039,052	9,573,598	53,756,598
Government	0	0	0	263	263
Total	50,849,790	75,260,620	87,128,272	60,184,407	273,423,089
2004					
AFF	229,352	430,095	512,372	343,169	1,514,988
Min	256	104	695	150,116	151,171
Const	4,325,965	5,685,550	9,678,753	12,644,345	32,334,613
Manu	1,116,143	1,807,647	1,752,124	975,316	5,651,230
TCPU	9,977,448	5,034,111	13,967,425	11,303,224	40,282,208
Whole	4,122,172	6,421,737	7,325,763	8,658,575	26,528,247
Retail	18,226,362	29,999,016	34,402,645	22,683,275	105,311,298
FIRE	2,247,358	2,619,310	3,341,741	3,964,014	12,172,423
Service	8,768,061	17,370,013	22,784,546	11,343,028	60,265,648
Government	394	0	0	0	394
Total	49,013,511	69,367,583	93,766,064	72,065,062	284,212,220

Table 2.5

Homer Sales

Homer TAXABLE Sales by Industry by Quarter - 2001-2004 - in \$					
	1st Quarter	2nd Quarter	3rd Quarter	4th Quarter	Total
2001					
AFF	108,289	146,035	177,823	145,213	577,360
Min	1,640	1,549	2,175	629	5,993
Const	178,792	217,384	280,862	263,173	940,211
Manu	325,875	528,377	525,720	389,562	1,769,534
TCPU	2,129,650	2,581,062	3,245,406	2,244,804	10,200,922
Whole	1,691,835	2,538,512	2,883,405	1,839,573	8,953,325
Retail	9,549,519	15,861,254	18,278,875	12,338,158	56,027,806
FIRE	692,034	923,819	1,006,507	838,352	3,460,712
Service	3,087,570	7,393,485	11,173,929	3,720,692	25,375,676
Government	0	0	0	0	0
Total	17,765,204	30,191,477	37,574,702	21,780,156	107,311,539
2002					
AFF	117,273	166,982	195,905	161,134	641,294
Min	710	1,955	0	0	2,665
Const	237,634	266,994	324,412	296,675	1,125,715
Manu	263,252	557,095	597,126	404,872	1,822,345
TCPU	2,225,122	2,873,043	3,752,729	2,847,193	11,698,087
Whole	1,662,455	2,518,226	2,928,198	1,767,769	8,876,648
Retail	10,100,688	18,247,283	21,308,629	14,208,287	63,864,887
FIRE	768,568	1,005,737	1,165,651	950,729	3,890,685
Service	3,321,402	8,630,174	12,978,461	4,415,755	29,345,792
Government	0	0	0	0	0
Total	18,697,104	34,267,489	43,251,111	25,052,414	121,268,118
2003					
AFF	135,734	212,539	250,473	174,675	773,421
Min	0	0	0	347	347
Const	239,346	310,150	333,795	317,118	1,200,409
Manu	277,526	532,466	618,081	420,093	1,848,166
TCPU	2,890,615	3,212,975	3,752,532	2,860,937	12,717,059
Whole	2,010,808	2,966,252	3,370,701	2,263,324	10,611,085
Retail	11,998,705	19,762,887	22,642,061	15,420,014	69,823,667
FIRE	900,146	1,062,609	1,146,791	965,111	4,074,657
Service	3,993,060	8,965,906	12,965,331	4,649,854	30,574,151
Government	0	0	0	263	263
Total	22,445,940	37,025,784	45,079,765	27,071,736	131,623,225
2004					
AFF	157,957	247,630	305,982	195,762	907,331
Min	0	104	0	0	104
Const	276,885	319,319	300,979	284,203	1,181,386
Manu	305,351	608,034	632,048	306,985	1,852,418
TCPU	2,806,506	3,248,197	3,909,932	2,675,515	12,640,150
Whole	2,234,379	3,320,836	3,998,096	1,876,182	11,429,493
Retail	12,978,758	21,248,831	24,159,875	15,575,201	73,962,665
FIRE	890,703	1,153,472	1,453,905	1,652,329	5,150,409
Service	4,170,155	9,495,791	14,204,599	4,705,847	32,576,392
Government	394	0	0	0	394
Total	23,821,088	39,642,214	48,965,416	27,272,024	139,700,742

Table 2.6

Homer Construction Permitting

Homer 4th QUARTER Permit VALUES by Type - 1998-2004 - in \$								
	1998	1999	2000	2001	2002	2003	2004	Annual Change
Residential New	761,750	195,000	326,000	492,300	560,200	1,222,900	377,000	-69.2%
Residential Alter/Add	145,000	50,000	0	120,000	104,320	50,000	437,000	774.0%
Commercial New	1,259,000	316,000	48,000	300,000	78,000	1,600,000	2,560,000	60.0%
Commercial Alter/Add	40,000	0	543,982	11,100,000	72,000	170,000	17,000	-90.0%
Total	2,205,750	561,000	917,982	12,012,300	814,520	3,042,900	3,391,000	11.4%
Annual Change		-74.6%	63.6%	1208.6%	-93.2%	273.6%	11.4%	

Table 2.7

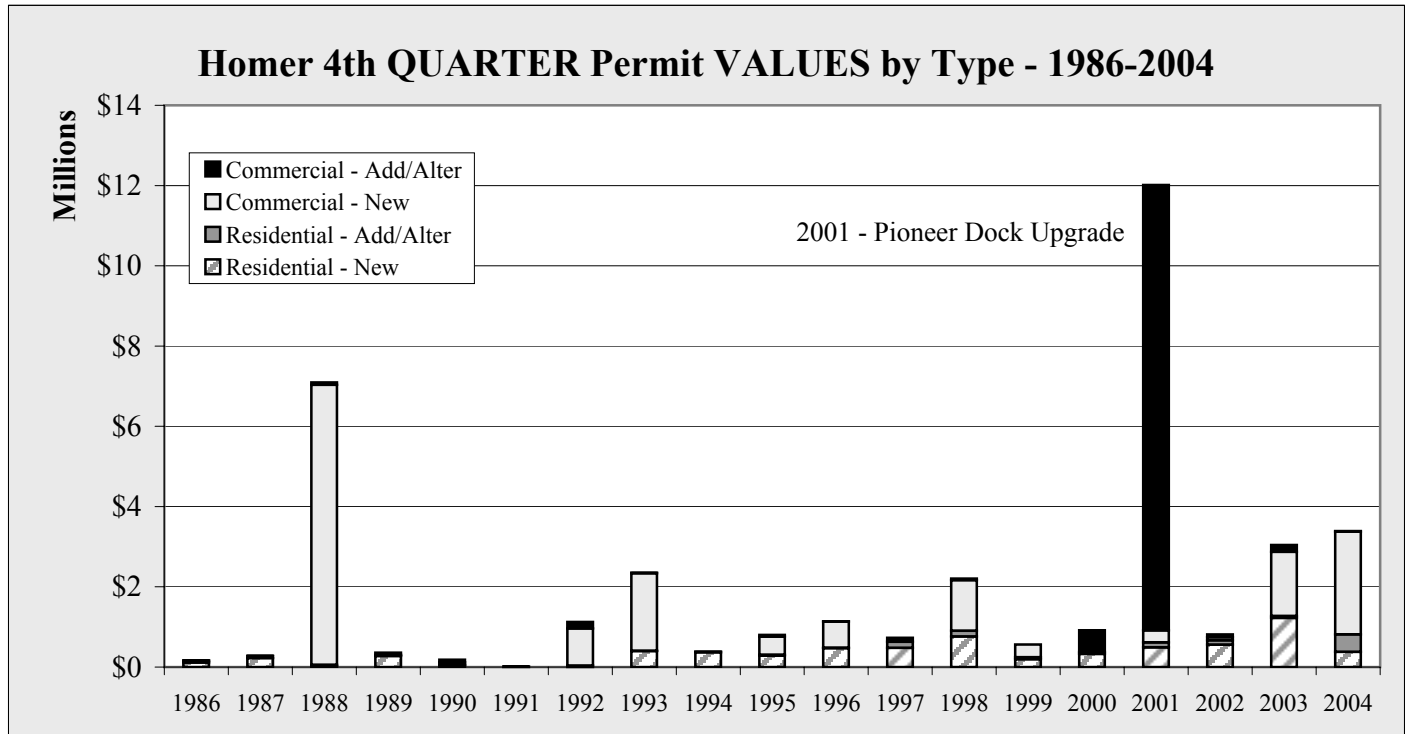

Chart 2.9

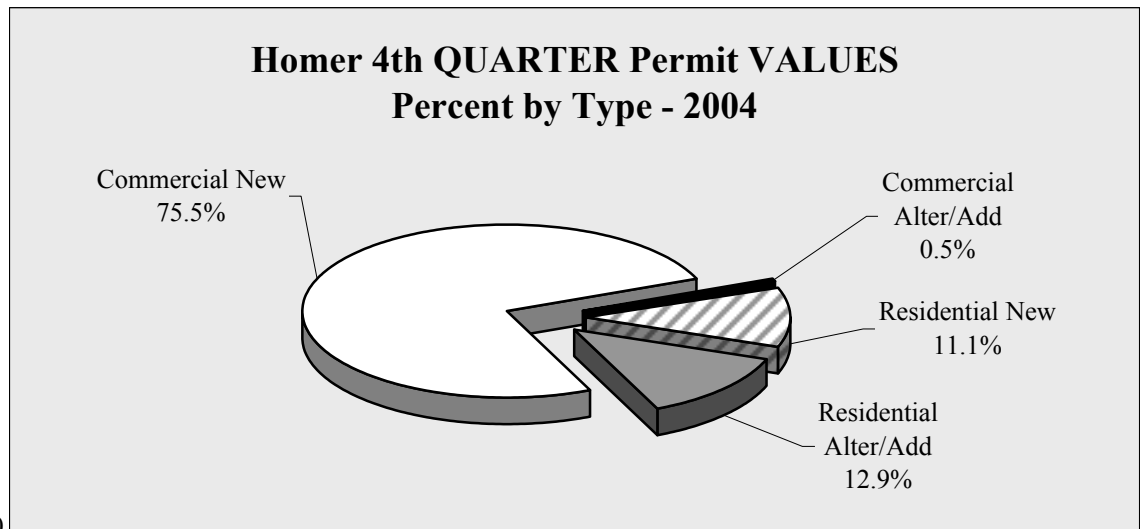

Chart 2.10

Homer Construction Permitting

Homer 4th QUARTER Permit VOLUME by Type - 1998-2004								
	1998	1999	2000	2001	2002	2003	2004	Annual Change
Residential New	6	3	4	4	5	9	6	-33.3%
Residential Alter/Add	2	2	0	2	6	2	9	350.0%
Commercial New	1	1	2	1	1	1	7	600.0%
Commercial Alter/Add	1	0	2	2	1	1	2	100.0%
Total	10	6	8	9	13	13	24	84.6%
Annual Change		-40.0%	33.3%	12.5%	44.4%	0.0%	84.6%	

Table 2.8

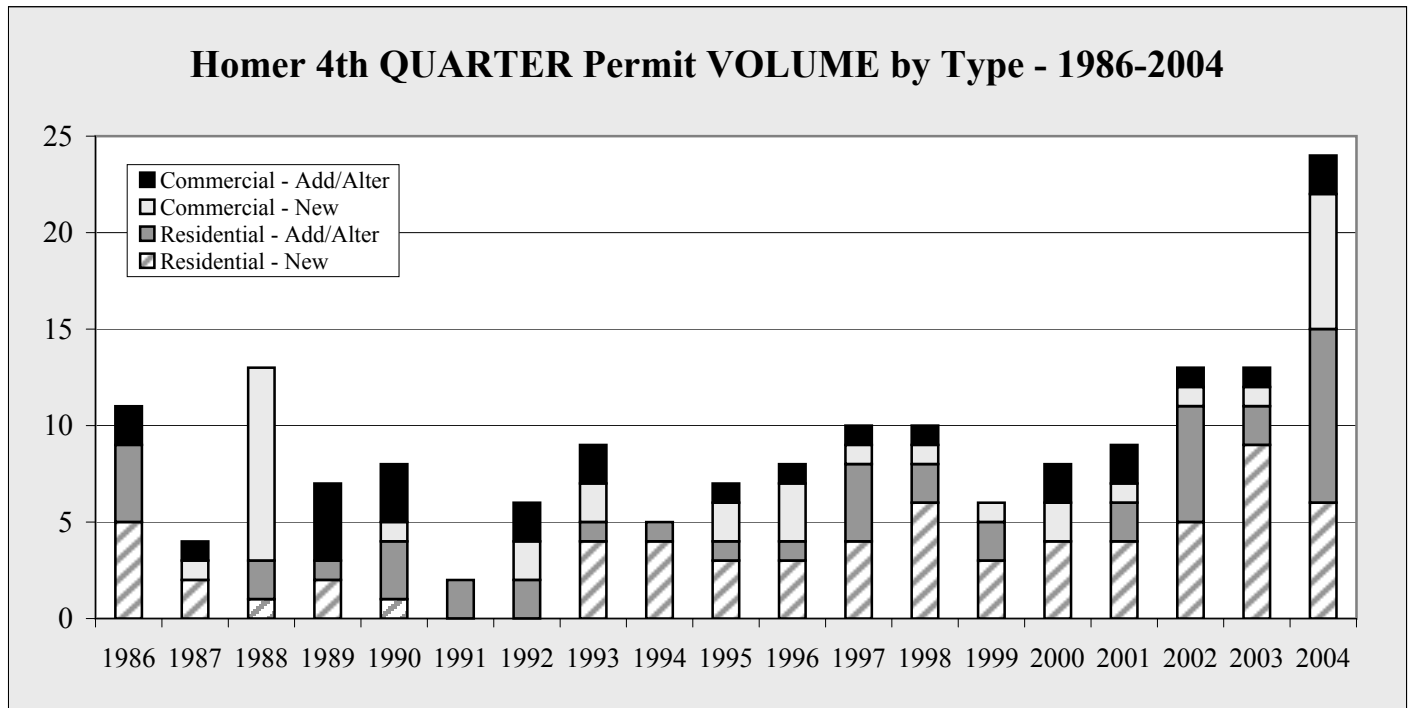

Chart 2.11

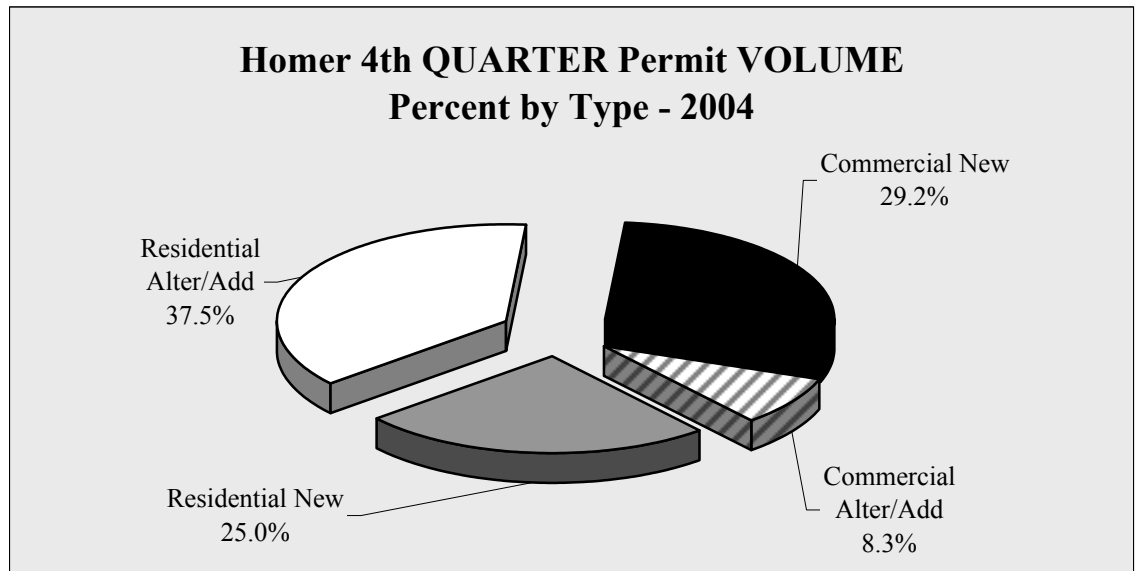

Chart 2.12

Homer Construction Permitting

Homer ANNUAL Permit VALUES by Type - 1998-2004 - in \$								
	1998	1999	2000	2001	2002	2003	2004	Annual Change
Residential New	2,850,750	3,646,000	2,611,040	4,047,780	4,226,720	8,120,455	6,695,500	-17.5%
Residential Alter/Add	539,600	367,000	230,060	609,160	536,620	806,600	1,695,550	110.2%
Commercial New	2,528,025	6,906,000	1,663,480	2,410,800	4,990,740	5,764,520	14,400,518	149.8%
Commercial Alter/Add	281,500	21,000	2,624,392	12,732,950	294,699	635,240	1,279,063	101.4%
Total	6,199,875	10,940,000	7,128,972	19,800,690	10,048,779	15,326,815	24,070,631	57.0%
Annual Change		76.5%	-34.8%	177.7%	-49.3%	52.5%	57.0%	

Table 2.9

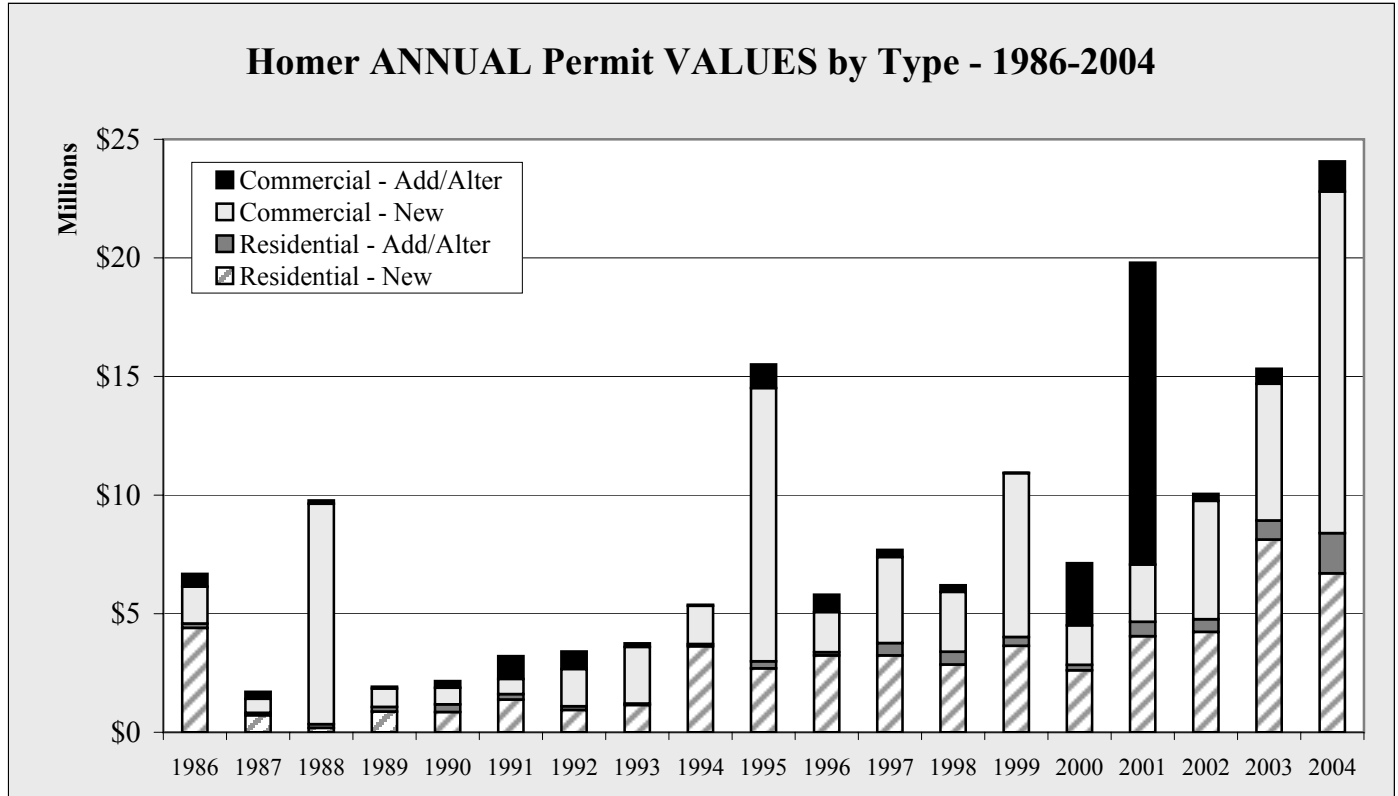

Chart 2.13

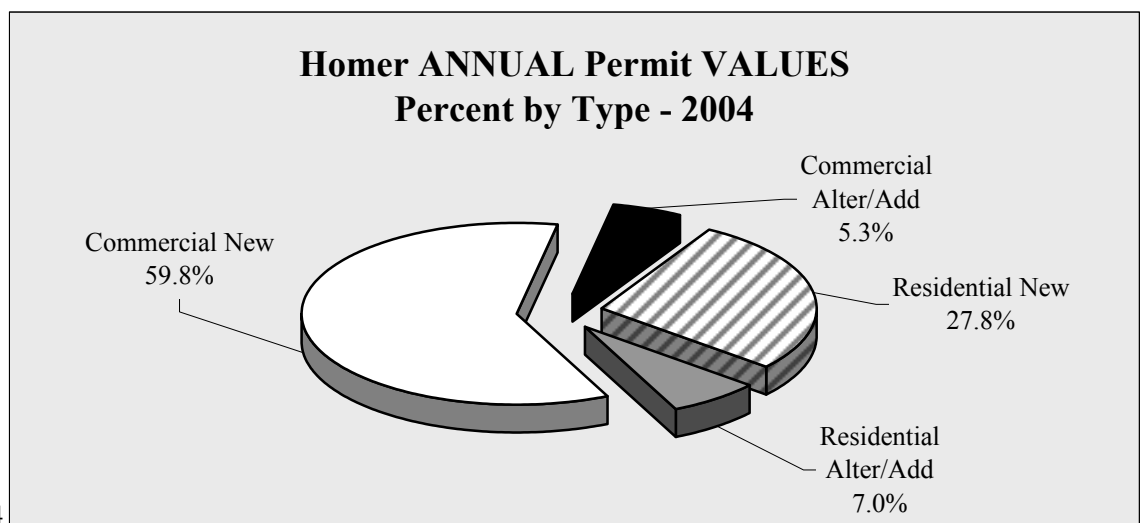

Chart 2.14

Homer Construction Permitting

Homer ANNUAL Permit VOLUME by Type - 1998-2004								
	1998	1999	2000	2001	2002	2003	2004	Annual Change
Residential New	23	21	23	30	32	47	41	-12.8%
Residential Alter/Add	11	17	8	19	20	19	37	94.7%
Commercial New	9	12	8	8	8	11	22	100.0%
Commercial Alter/Add	5	2	19	15	7	9	8	-11.1%
Total	48	52	58	72	67	86	108	25.6%
Annual Change		8.3%	11.5%	24.1%	-6.9%	28.4%	25.6%	

Table 2.10

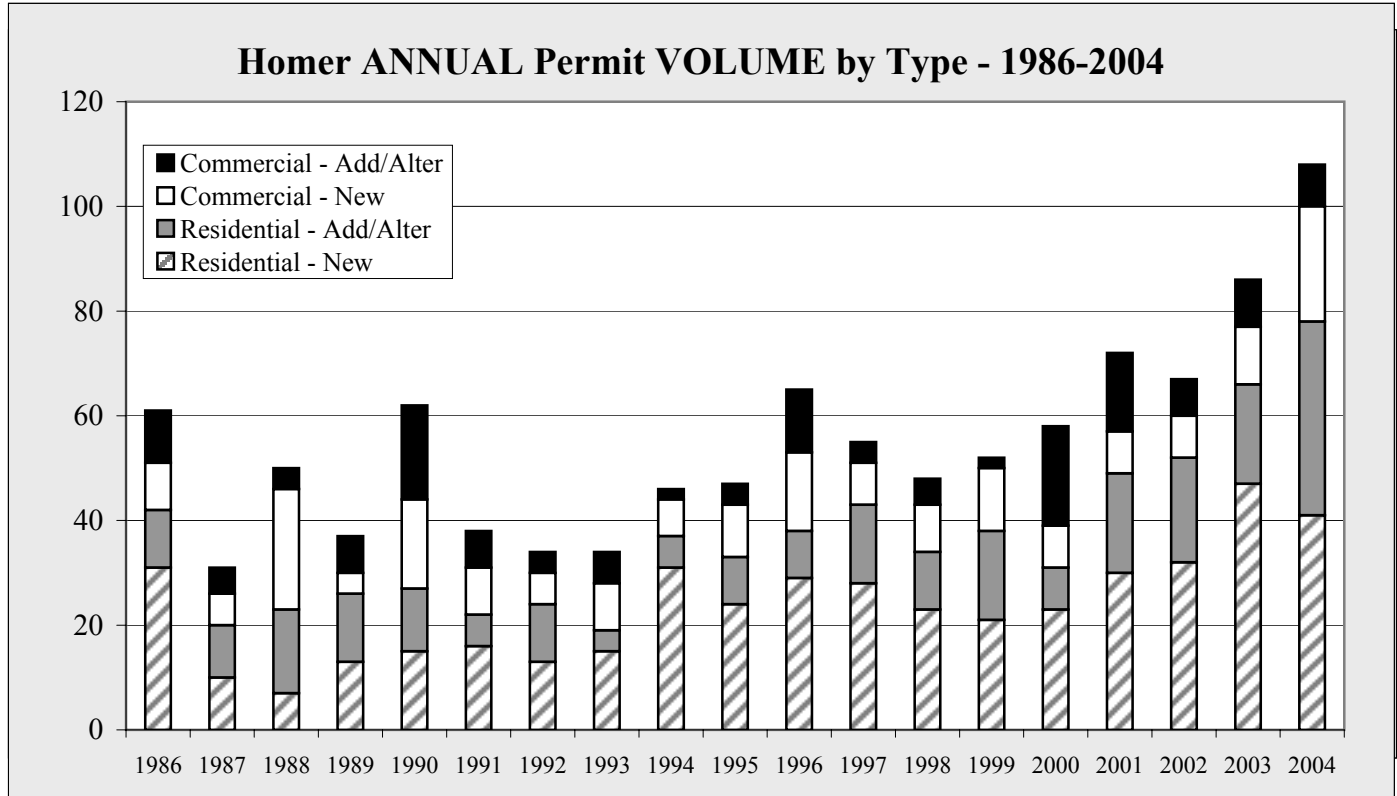

Chart 2.15

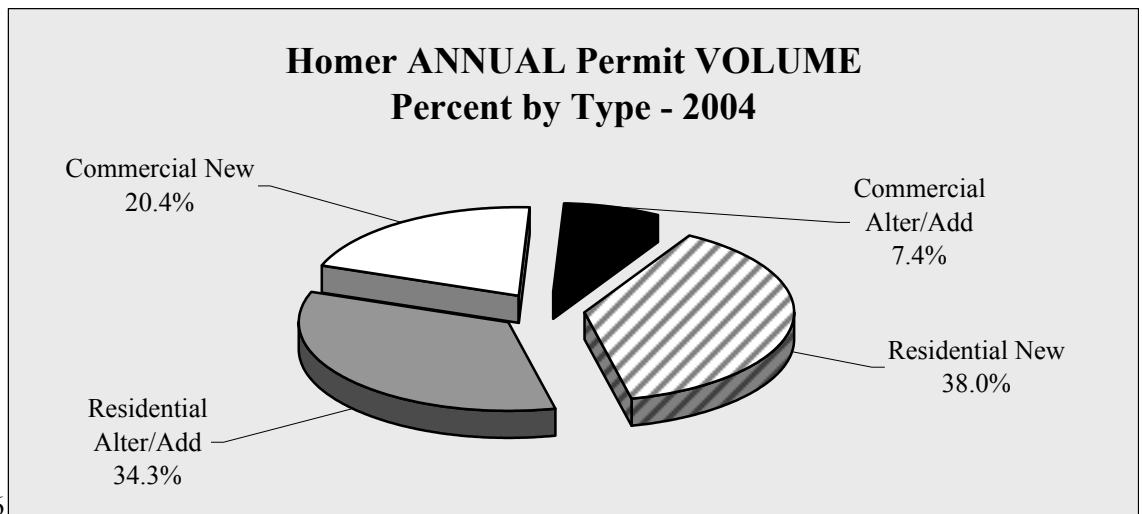

Chart 2.16

Homer Construction Permitting

Homer Annual Permit VALUES by Type by Quarter - 1997-2004 - in \$					
	1st Quarter	2nd Quarter	3rd Quarter	4th Quarter	Total
1997					
Residential - New	435,000	842,500	1,478,900	480,000	3,236,400
Residential - Add/Alter	0	324,500	44,365	150,000	518,865
Commercial - New	2,150,000	1,321,000	159,000	0	3,630,000
Commercial - Add/Alter	45,000	20,000	139,000	100,000	304,000
TOTAL	2,630,000	2,508,000	1,821,265	730,000	7,689,265
1998					
Residential - New	594,000	875,000	620,000	761,750	2,850,750
Residential - Add/Alter	0	140,400	254,200	145,000	539,600
Commercial - New	35,970	1,192,036	41,019	1,259,000	2,528,025
Commercial - Add/Alter	0	66,500	175,000	40,000	281,500
TOTAL	629,970	2,273,936	1,090,219	2,205,750	6,199,875
1999					
Residential - New	1,673,000	1,038,000	740,000	195,000	3,646,000
Residential - Add/Alter	0	118,000	199,000	50,000	367,000
Commercial - New	270,000	1,520,000	4,800,000	316,000	6,906,000
Commercial - Add/Alter	0	15,000	6,000	0	21,000
TOTAL	1,943,000	2,691,000	5,745,000	561,000	10,940,000
2000					
Residential - New	392,600	867,440	1,025,000	326,000	2,611,040
Residential - Add/Alter	5,500	115,000	109,560	0	230,060
Commercial - New	85,000	725,480	805,000	48,000	1,663,480
Commercial - Add/Alter	1,315,000	558,000	207,410	543,982	2,624,392
TOTAL	1,798,100	2,265,920	2,146,970	917,982	7,128,972
2001					
Residential - New	300,000	2,093,800	1,161,680	492,300	4,047,780
Residential - Add/Alter	60,000	306,440	122,720	120,000	609,160
Commercial - New	285,000	1,485,800	340,000	300,000	2,410,800
Commercial - Add/Alter	45,000	216,000	1,371,950	11,100,000	12,732,950
TOTAL	690,000	4,102,040	2,996,350	12,012,300	19,800,690
2002					
Residential - New	891,760	1,308,460	1,466,300	560,200	4,226,720
Residential - Add/Alter	8,960	205,400	217,940	104,320	536,620
Commercial - New	0	1,000,000	3,912,740	78,000	4,990,740
Commercial - Add/Alter	28,000	14,349	180,350	72,000	294,699
TOTAL	928,720	2,528,209	5,777,330	814,520	10,048,779
2003					
Residential - New	979,800	3,811,480	2,106,275	1,222,900	8,120,455
Residential - Add/Alter	232,540	239,060	285,000	50,000	806,600
Commercial - New	0	3,535,720	628,800	1,600,000	5,764,520
Commercial - Add/Alter	122,000	343,240	0	170,000	635,240
TOTAL	1,334,340	7,929,500	3,020,075	3,042,900	15,326,815
2004					
Residential - New	2,597,500	2,495,400	1,225,600	377,000	6,695,500
Residential - Add/Alter	201,520	205,730	851,300	437,000	1,695,550
Commercial - New	915,000	4,700,518	6,225,000	2,560,000	14,400,518
Commercial - Add/Alter	0	32,063	1,230,000	17,000	1,279,063
TOTAL	3,714,020	7,433,711	9,531,900	3,391,000	24,070,631

Table 2.11

Homer Construction Permitting

Homer Annual Permit VOLUME by Type by Quarter - 1997-2004					
	1st Quarter	2nd Quarter	3rd Quarter	4th Quarter	Total
1997					
Residential - New	3	8	13	4	28
Residential - Add/Alter	0	8	3	4	15
Commercial - New	2	2	3	1	8
Commercial - Add/Alter	1	1	1	1	4
TOTAL	6	19	20	10	55
1998					
Residential - New	5	6	6	6	23
Residential - Add/Alter	0	4	5	2	11
Commercial - New	1	5	2	1	9
Commercial - Add/Alter	0	3	1	1	5
TOTAL	6	18	14	10	48
1999					
Residential - New	3	9	6	3	21
Residential - Add/Alter	0	4	11	2	17
Commercial - New	2	7	2	1	12
Commercial - Add/Alter	0	1	1	0	2
TOTAL	5	21	20	6	52
2000					
Residential - New	4	7	8	4	23
Residential - Add/Alter	1	2	5	0	8
Commercial - New	1	3	2	2	8
Commercial - Add/Alter	3	8	6	2	19
TOTAL	9	20	21	8	58
2001					
Residential - New	3	14	9	4	30
Residential - Add/Alter	1	12	4	2	19
Commercial - New	2	3	2	1	8
Commercial - Add/Alter	1	5	7	2	15
TOTAL	7	34	22	9	72
2002					
Residential - New	8	9	10	5	32
Residential - Add/Alter	1	5	8	6	20
Commercial - New	0	1	6	1	8
Commercial - Add/Alter	1	2	3	1	7
TOTAL	10	17	27	13	67
2003					
Residential - New	6	17	15	9	47
Residential - Add/Alter	8	6	3	2	19
Commercial - New	0	7	3	1	11
Commercial - Add/Alter	4	4	0	1	9
TOTAL	18	34	21	13	86
2004					
Residential - New	11	15	9	6	41
Residential - Add/Alter	2	5	21	9	37
Commercial - New	2	5	8	7	22
Commercial - Add/Alter	1	1	4	2	8
TOTAL	16	26	42	24	108

Table 2.12

Homer Cost of Food Survey

Cost of food data is collected by the University of Alaska, Fairbanks Cooperative Extension. In each quarter the Cooperative Extension surveys up to three grocers in communities throughout the state to determine the cost of food for one week. Specific guidelines are presented to the surveyors regarding item size and sale price for 104 items.

HOMER						
	Dec-99	Dec-00	Dec-01	Dec-02	Dec-03	Dec-04
Sales Tax (in percent)	5.5	5.5	5.5	5.5	5.5	5.5
Percent of Food Unavailable	7.0	2.0	1.0	3.0	0.0	0.0
						0.0
Child 1 year	23.59	20.23	21.29	22.12	21.79	22.56
Child 2 years	0.00	0.00	21.29	22.12	21.38	22.32
Children 3-5 years	25.81	22.20	23.38	24.29	23.48	24.51
Children 6-8 years	34.33	29.57	31.05	32.38	31.57	33.00
Children 9-11 years	38.90	33.52	35.23	36.69	35.47	37.08
Males 12-14 years	43.97	37.76	39.86	41.45	39.96	41.88
Males 15-19 years	45.20	38.91	41.11	42.74	41.16	43.13
Males 20-50 years	44.95	38.69	40.90	42.64	41.28	43.27
Males 51 years & over	42.73	36.95	38.91	40.58	39.57	41.48
Females 12-19 years	37.79	32.59	34.39	35.72	34.68	36.35
Females 20-50 years	39.15	33.93	35.64	37.24	36.07	37.84
Females 51 years and over	38.16	33.00	34.82	36.27	35.07	36.84
Family of 2 (20-50 years)	92.50	79.88	84.19	87.88	85.07	89.23
Family of 2 (51 & older)	89.04	76.93	81.11	84.54	82.12	86.15
Family of 4 children 1-5 years	133.50	115.05	121.21	126.28	122.20	127.96
Family of 4 children 6-11 years	157.34	135.72	142.82	148.95	144.38	151.19
Electricity, 1000 kWh	117.28	112.64	122.62	126.71	114.41	121.93
Heating oil, 55 gal	71.50	84.70	57.75	77.55	80.30	111.65
Gas-55 gal unleaded auto	81.95	100.88	85.75	94.00	102.80	118.75
Lumber, 2X4X8'	3.12	2.59	2.87	3.47	2.89	3.60
Propane, 100 LB refill	0.00	37.54	39.65	38.71	44.89	52.89

Table 2.13

Homer Cost of Food Survey

Each
state to
garding

Annual Change
3.5%
4.4%
4.4%
4.5%
4.5%
4.8%
4.8%
4.8%
4.8%
4.8%
4.9%
5.0%
4.9%
4.9%
4.7%
4.7%
6.6%
39.0%
15.5%
24.6%
17.8%

Homer Cost of Food Survey

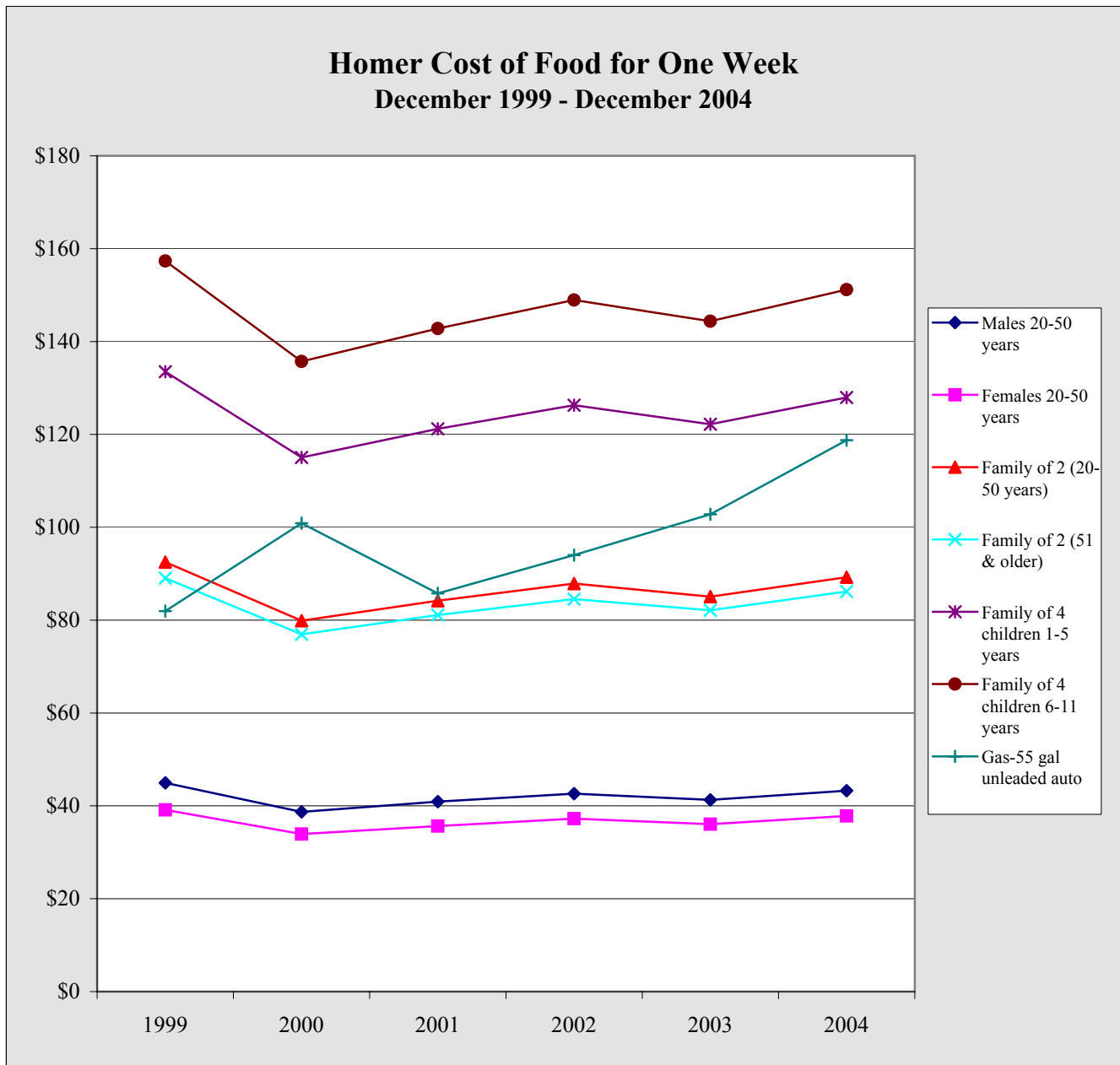

Chart 2.17

Kenai Sales

Kenai 4th Quarter GROSS Sales by Industry - 1998-2004 - in \$								
	1998	1999	2000	2001	2002	2003	2004	Annual Change
AFF	2,414,459	1,208,946	147,395	825,507	227,354	470,121	1,748,879	272.0%
Min	21,156	911,206	1,357,532	520,572	379,608	1,583,457	2,357,708	48.9%
Const	5,761,348	7,663,858	4,782,252	6,858,111	5,458,971	12,200,692	4,088,311	-66.5%
Manu	1,826,500	2,053,148	2,807,139	2,894,059	3,767,980	2,258,019	2,037,898	-9.7%
TCPU	5,893,200	8,441,455	6,008,325	6,372,561	7,120,726	5,941,515	5,999,635	1.0%
Whole	2,383,031	2,774,886	5,106,481	4,233,797	4,069,622	5,333,838	6,326,294	18.6%
Retail	38,027,088	34,505,929	40,741,748	41,619,799	34,670,657	30,062,588	36,602,736	21.8%
FIRE	2,571,040	2,586,301	3,355,291	3,810,903	3,049,232	3,350,119	3,233,035	-3.5%
Service	8,711,175	7,804,528	8,102,564	9,287,393	9,873,954	11,345,461	10,171,821	-10.3%
Govt	93	72	32	0	0	0	0	NA
Total	67,609,090	67,950,329	72,408,759	76,422,702	68,618,104	72,545,810	72,566,317	0.03%
Annual Change		0.5%	6.6%	5.5%	-10.2%	5.7%	0.03%	

Table 3.1

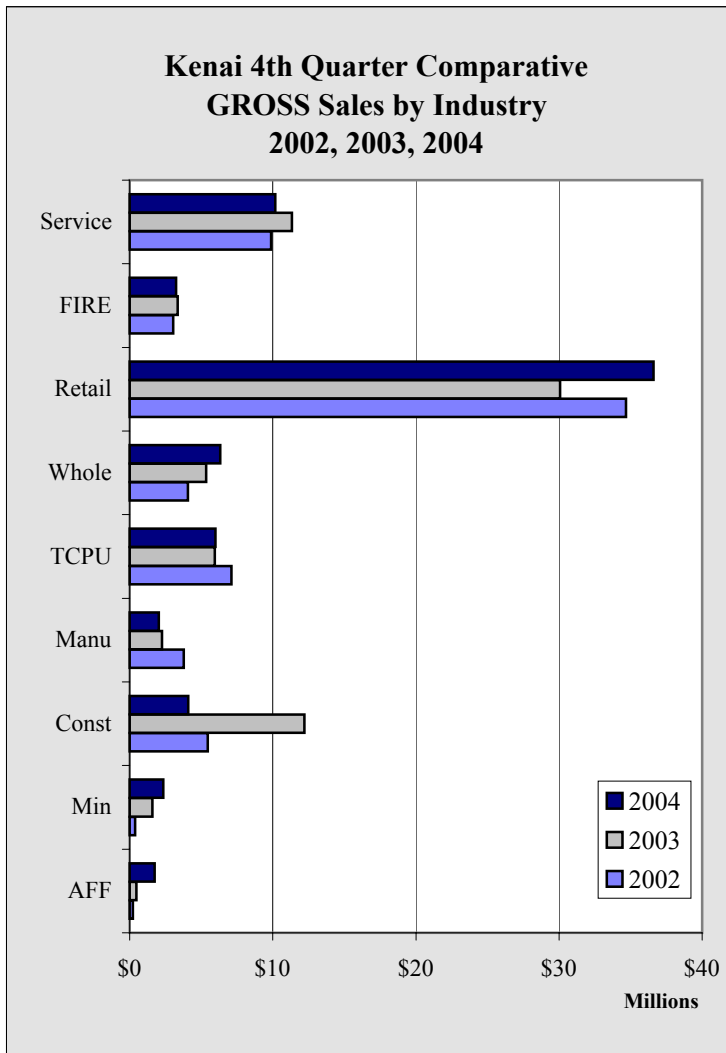

Chart 3.1

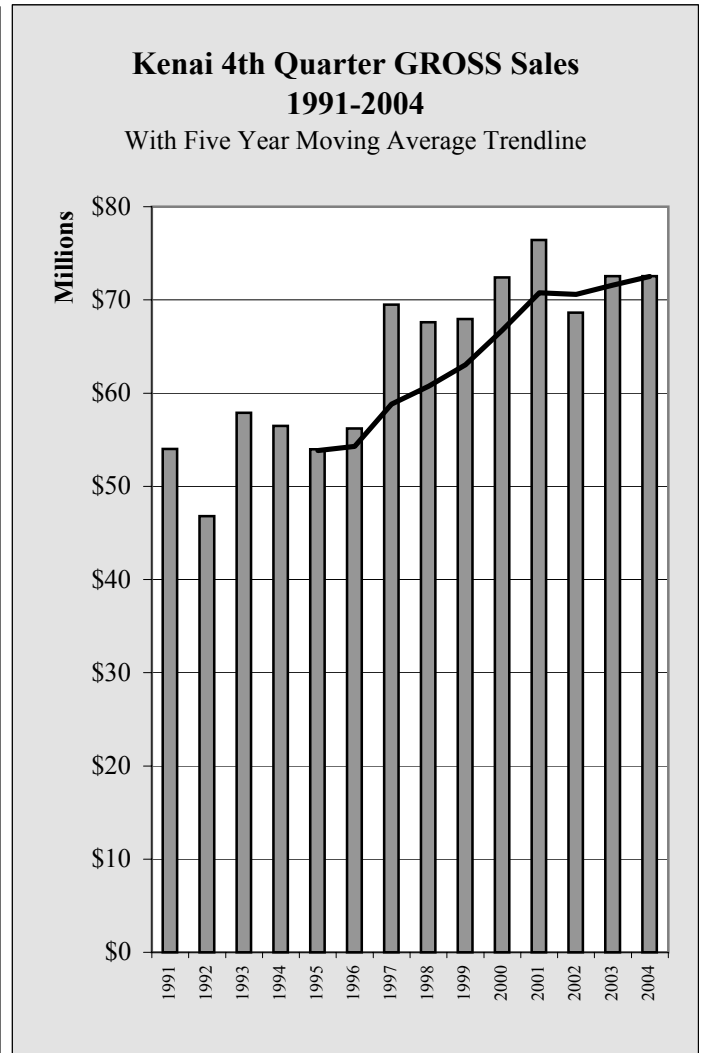

Chart 3.2

Kenai Sales

Kenai 4th Quarter TAXABLE Sales by Industry - 1998-2004 - in \$								
	1998	1999	2000	2001	2002	2003	2004	Annual Change
AFF	93,304	91,253	89,000	100,269	86,211	99,292	109,314	10.1%
Min	8,764	40,690	46,005	41,886	52,224	60,465	66,021	9.2%
Const	328,236	323,173	287,662	354,826	296,515	317,640	264,939	-16.6%
Manu	394,728	442,960	552,715	414,560	491,314	506,419	514,348	1.6%
TCPU	3,327,590	5,377,374	3,237,855	3,457,229	4,309,543	3,632,232	3,478,103	-4.2%
Whole	217,893	217,551	203,256	153,504	123,316	180,546	103,885	-42.5%
Retail	22,614,704	22,296,352	23,950,857	25,525,358	23,983,760	18,669,361	22,931,159	22.8%
FIRE	1,213,222	1,146,639	1,615,987	1,768,098	1,564,165	1,252,833	1,197,436	-4.4%
Service	3,758,639	3,781,751	4,078,976	4,187,469	4,081,675	4,369,744	4,116,935	-5.8%
Govt	86	72	32	0	0	0	0	NA
Total	31,957,166	33,717,815	34,062,345	36,003,199	34,988,723	29,088,532	32,782,140	12.7%
Annual Change		5.5%	1.0%	5.7%	-2.8%	-16.9%	12.7%	

Table 3.2

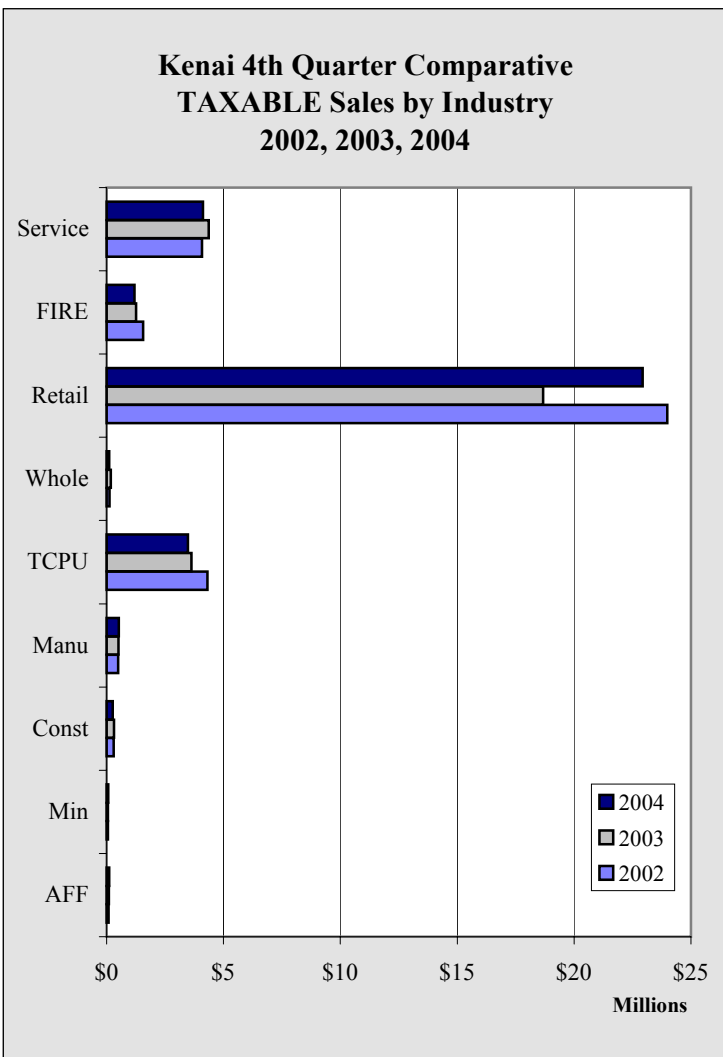

Chart 3.3

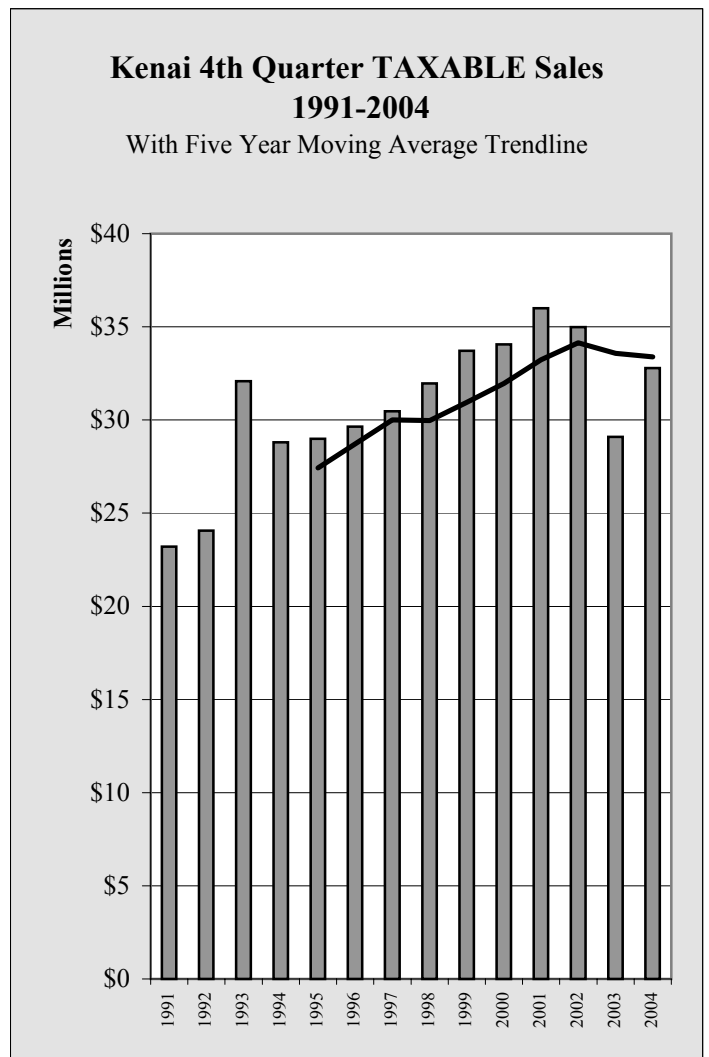

Chart 3.4

Kenai Sales

Kenai Annual GROSS Sales by Industry - 1998-2004 - in \$								
	1998	1999	2000	2001	2002	2003	2004	Annual Change
AFF	21,856,770	27,031,481	17,757,626	11,304,090	9,488,174	16,349,069	16,349,069	0.0%
Min	208,531	1,424,691	5,507,130	2,507,234	3,916,074	4,915,930	8,727,840	77.5%
Const	21,481,466	20,692,714	17,177,398	24,151,985	18,522,782	30,636,346	12,795,111	-58.2%
Manu	7,526,545	7,854,159	10,445,806	12,646,047	12,496,147	14,994,862	9,468,643	-36.9%
TCPU	23,017,785	26,815,943	23,883,929	24,107,421	27,762,814	24,667,417	29,865,550	21.1%
Whole	10,194,981	10,520,958	17,902,155	19,965,613	17,521,629	19,037,117	25,040,886	31.5%
Retail	149,397,570	133,272,201	145,306,370	164,046,542	134,565,667	119,219,213	146,342,803	22.8%
FIRE	10,300,066	10,463,600	11,935,000	13,853,920	13,529,801	12,784,912	12,748,094	-0.3%
Service	36,094,281	32,669,956	33,766,762	37,842,360	41,942,315	44,500,264	46,835,474	5.2%
Govt	1,945	415	288	1,213	0	0	0	NA
Total	280,079,940	270,746,118	283,682,464	310,426,425	279,745,403	283,340,242	308,173,470	8.8%
Annual Change		-3.3%	4.8%	9.4%	-9.9%	1.3%	8.8%	

Table 3.3

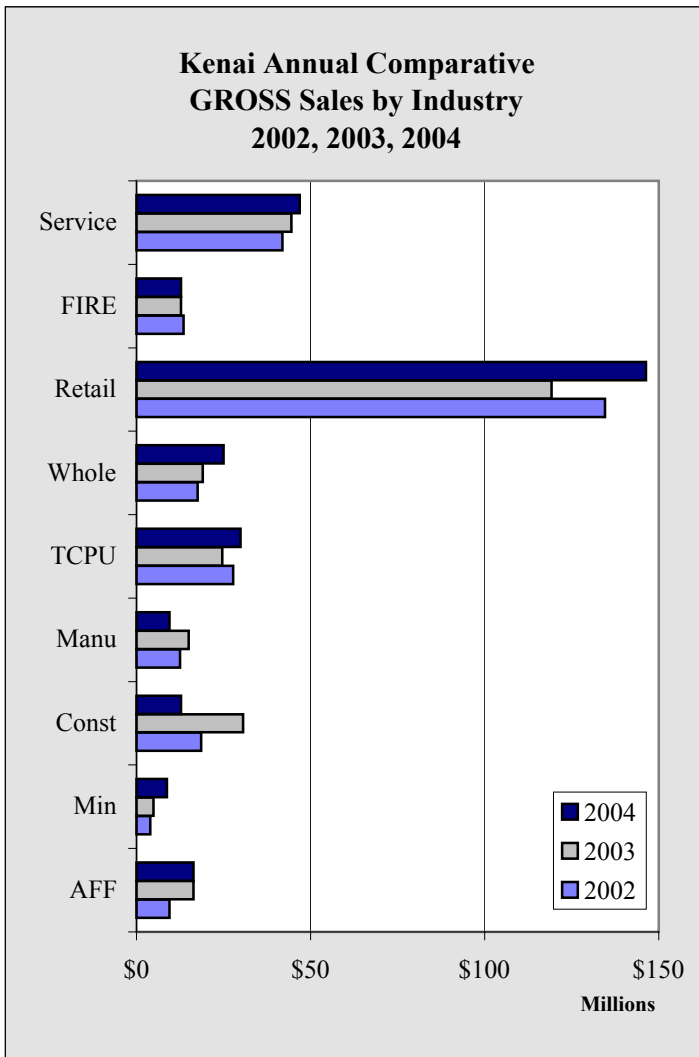

Chart 3.5

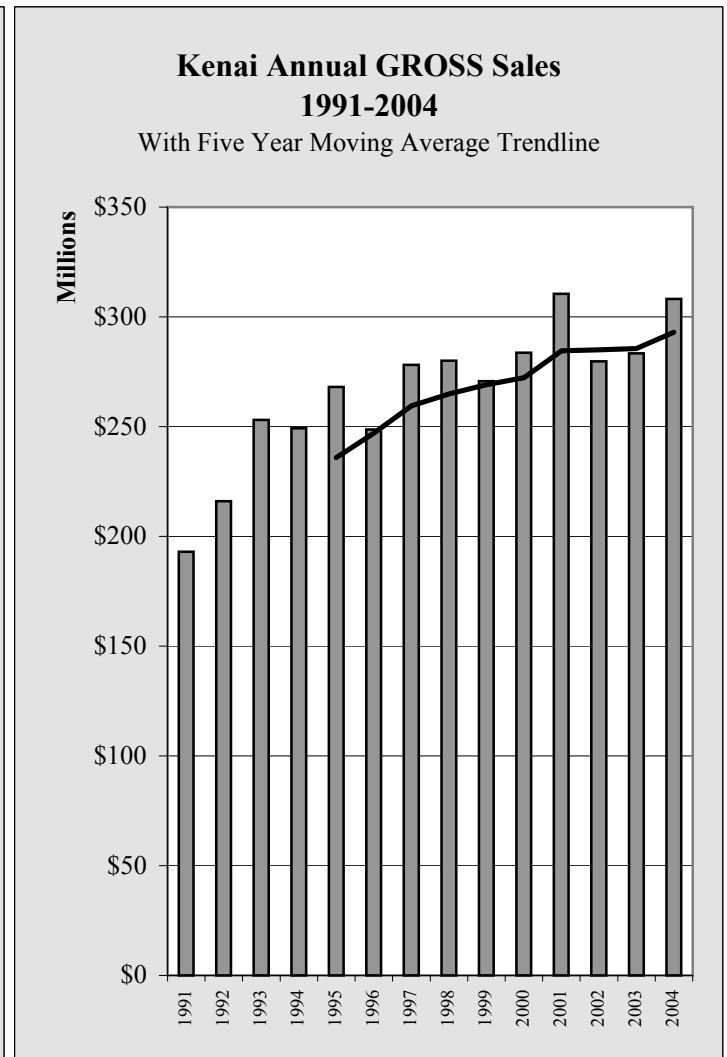

Chart 3.6

Kenai Sales

Kenai Annual TAXABLE Sales by Industry - 1998-2004 - in \$								
	1998	1999	2000	2001	2002	2003	2004	Annual Change
AFF	448,689	513,026	518,603	505,615	505,614	559,313	717,590	28.3%
Min	49,522	96,651	166,846	223,196	213,971	192,718	262,963	36.4%
Const	1,200,303	1,180,607	1,085,964	1,171,924	1,111,101	1,172,308	1,138,497	-2.9%
Manu	2,140,912	2,085,657	2,450,721	2,238,645	2,218,515	2,451,929	2,850,107	16.2%
TCPU	12,899,378	15,330,911	13,458,834	13,192,948	16,120,066	15,890,944	14,082,886	-11.4%
Whole	877,088	829,682	898,759	727,784	517,025	589,496	576,690	-2.2%
Retail	80,814,442	81,828,974	85,347,467	93,226,651	90,195,938	76,153,080	94,537,611	24.1%
FIRE	4,918,254	4,824,067	5,718,387	6,757,340	6,600,246	5,601,342	5,161,775	-7.8%
Service	16,680,181	17,677,101	18,120,257	18,998,608	19,287,134	18,796,331	19,541,708	4.0%
Govt	1,938	415	288	1,213	0	0	0	NA
Total	120,030,707	124,367,091	127,766,126	137,043,924	136,769,610	121,407,461	138,869,827	14.4%
Annual Change		3.6%	2.7%	7.3%	-0.2%	-11.2%	14.4%	

Table 3.4

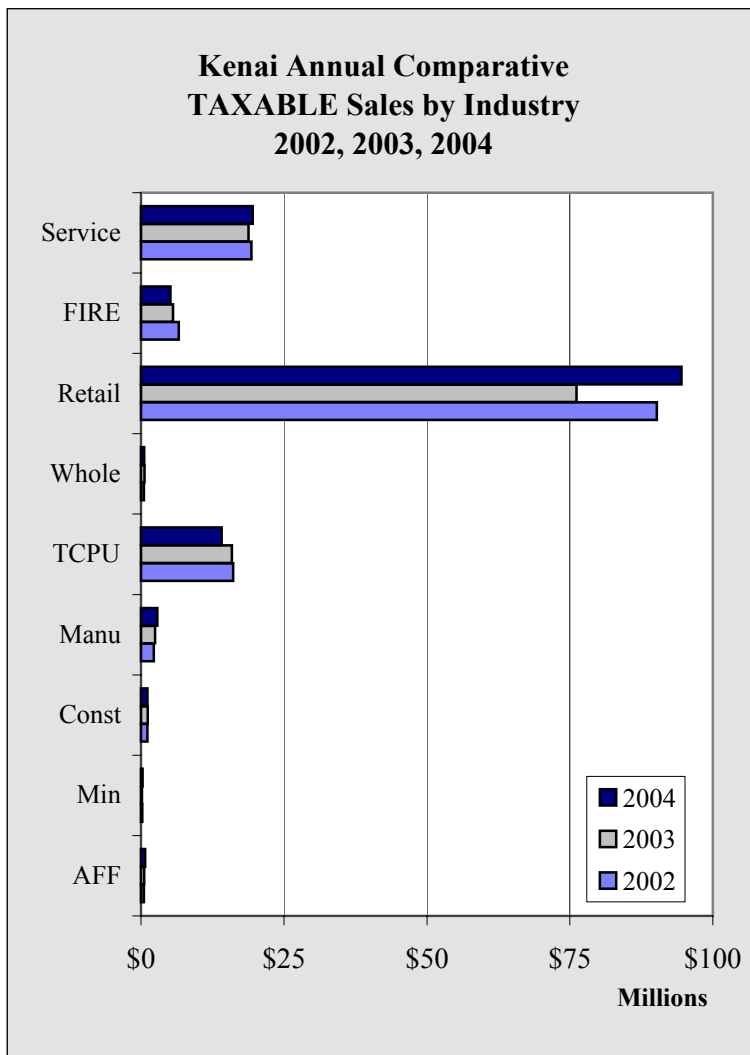

Chart 3.7

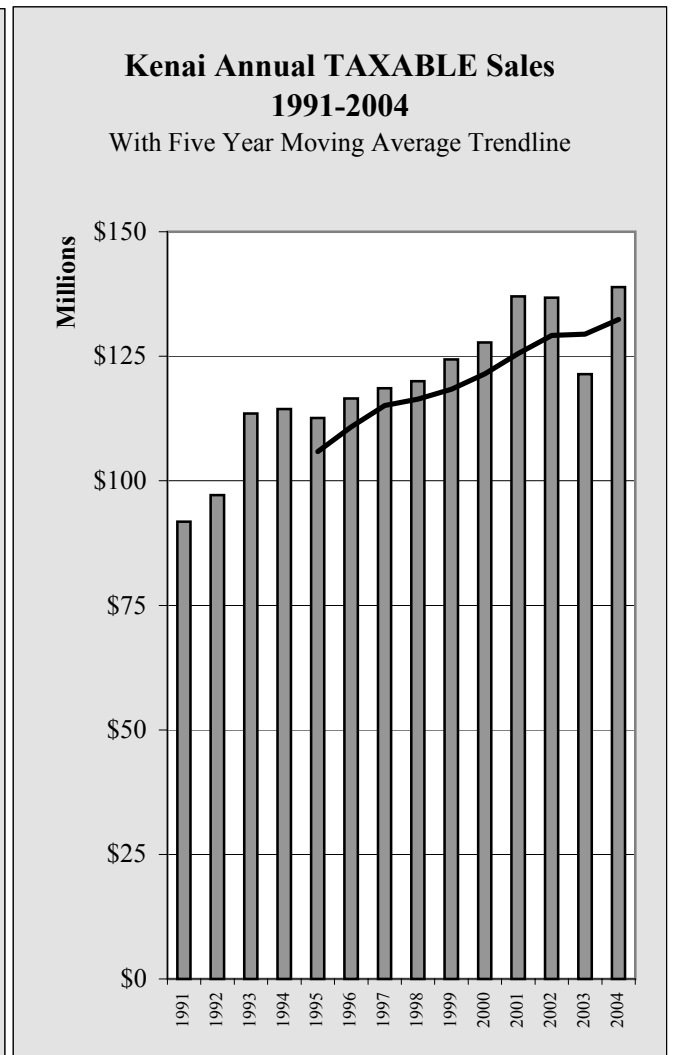

Chart 3.8

Kenai Sales

Kenai GROSS Sales by Industry by Quarter - 2001-2004 - in \$					
	1st Quarter	2nd Quarter	3rd Quarter	4th Quarter	Total
2001					
AFF	633,357	787,584	9,057,642	825,507	11,304,090
Min	852,594	321,650	812,418	520,572	2,507,234
Const	1,914,204	5,291,031	10,088,639	6,858,111	24,151,985
Manu	2,808,918	3,567,493	3,375,577	2,894,059	12,646,047
TCPU	6,078,860	5,834,997	5,821,003	6,372,561	24,107,421
Whole	4,987,946	5,243,400	5,500,470	4,233,797	19,965,613
Retail	34,150,036	42,832,698	45,444,009	41,619,799	164,046,542
FIRE	2,962,348	3,513,695	3,566,974	3,810,903	13,853,920
Service	8,030,023	9,281,388	11,243,556	9,287,393	37,842,360
Govt	0	0	1,213	0	1,213
Total	62,418,286	76,673,936	94,911,501	76,422,702	310,426,425
2002					
AFF	1,170,314	810,865	7,279,641	227,354	9,488,174
Min	2,214,717	516,408	805,341	379,608	3,916,074
Const	3,777,071	4,295,333	4,991,407	5,458,971	18,522,782
Manu	2,256,153	3,007,187	3,464,827	3,767,980	12,496,147
TCPU	6,416,059	6,155,532	8,070,497	7,120,726	27,762,814
Whole	3,364,888	4,677,095	5,410,024	4,069,622	17,521,629
Retail	28,474,145	34,741,208	36,679,657	34,670,657	134,565,667
FIRE	3,439,155	3,667,615	3,373,799	3,049,232	13,529,801
Service	9,483,867	10,058,048	12,526,446	9,873,954	41,942,315
Govt	0	0	0	0	0
Total	60,596,369	67,929,291	82,601,639	68,618,104	279,745,403
2003					
AFF	1,002,650	838,734	10,272,676	470,121	12,584,181
Min	942,570	872,788	1,517,115	1,583,457	4,915,930
Const	4,115,296	6,454,835	7,865,523	12,200,692	30,636,346
Manu	2,997,006	4,210,293	5,529,544	2,258,019	14,994,862
TCPU	7,714,369	6,152,058	4,859,475	5,941,515	24,667,417
Whole	3,221,739	4,841,740	5,639,800	5,333,838	19,037,117
Retail	30,107,230	28,949,996	30,099,399	30,062,588	119,219,213
FIRE	3,050,602	3,256,374	3,127,817	3,350,119	12,784,912
Service	8,988,895	11,847,481	12,318,427	11,345,461	44,500,264
Govt	0	0	0	0	0
Total	62,140,357	67,424,299	81,229,776	72,545,810	283,340,242
2004					
AFF	1,061,786	1,296,885	12,241,519	1,748,879	16,349,069
Min	2,011,733	2,172,358	2,186,041	2,357,708	8,727,840
Const	2,314,222	2,769,875	3,622,703	4,088,311	12,795,111
Manu	1,610,022	3,062,848	2,757,875	2,037,898	9,468,643
TCPU	6,489,016	5,560,861	11,816,038	5,999,635	29,865,550
Whole	5,447,260	5,963,008	7,304,324	6,326,294	25,040,886
Retail	29,814,280	39,251,887	40,673,900	36,602,736	146,342,803
FIRE	2,866,173	3,219,231	3,429,655	3,233,035	12,748,094
Service	10,452,168	12,113,596	14,097,889	10,171,821	46,835,474
Govt	0	0	0	0	0
Total	62,066,660	75,410,549	98,129,944	72,566,317	308,173,470

Table 3.5

Kenai Sales

Kenai TAXABLE Sales by Industry by Quarter - 2001-2004 - in \$					
	1st Quarter	2nd Quarter	3rd Quarter	4th Quarter	Total
2001					
AFF	88,262	113,069	204,015	100,269	505,615
Min	58,812	72,568	49,930	41,886	223,196
Const	237,187	268,682	311,229	354,826	1,171,924
Manu	437,740	685,042	701,303	414,560	2,238,645
TCPU	3,398,397	3,163,762	3,173,560	3,457,229	13,192,948
Whole	179,452	206,838	187,990	153,504	727,784
Retail	18,137,349	23,717,206	25,846,738	25,525,358	93,226,651
FIRE	1,527,679	1,670,033	1,791,530	1,768,098	6,757,340
Service	3,824,363	5,091,469	5,895,307	4,187,469	18,998,608
Govt	0	0	1,213	0	1,213
Total	27,889,241	34,988,669	38,162,815	36,003,199	137,043,924
2002					
AFF	90,609	128,556	200,238	86,211	505,614
Min	51,370	57,479	52,898	52,224	213,971
Const	248,573	273,401	292,612	296,515	1,111,101
Manu	349,360	622,875	754,966	491,314	2,218,515
TCPU	3,779,839	3,794,883	4,235,801	4,309,543	16,120,066
Whole	107,790	146,986	138,933	123,316	517,025
Retail	18,685,738	22,876,325	24,650,115	23,983,760	90,195,938
FIRE	1,645,401	1,684,226	1,706,454	1,564,165	6,600,246
Service	3,979,662	5,064,834	6,160,963	4,081,675	19,287,134
Govt	0	0	0	0	0
Total	28,938,342	34,649,565	38,192,980	34,988,723	136,769,610
2003					
AFF	87,894	134,783	237,344	99,292	559,313
Min	34,119	46,723	51,411	60,465	192,718
Const	242,193	295,969	316,506	317,640	1,172,308
Manu	441,292	687,335	816,883	506,419	2,451,929
TCPU	4,932,006	4,056,076	3,270,630	3,632,232	15,890,944
Whole	102,588	139,469	166,893	180,546	589,496
Retail	20,062,767	18,246,087	19,174,865	18,669,361	76,153,080
FIRE	1,480,683	1,494,804	1,373,022	1,252,833	5,601,342
Service	3,732,984	4,727,913	5,965,690	4,369,744	18,796,331
Govt	0	0	0	0	0
Total	31,116,526	29,829,159	31,373,244	29,088,532	121,407,461
2004					
AFF	97,275	159,363	351,638	109,314	717,590
Min	63,827	57,575	75,540	66,021	262,963
Const	270,414	294,583	308,561	264,939	1,138,497
Manu	508,762	803,910	1,023,087	514,348	2,850,107
TCPU	3,939,435	3,467,903	3,197,445	3,478,103	14,082,886
Whole	175,813	154,306	142,686	103,885	576,690
Retail	19,316,910	25,145,460	27,144,082	22,931,159	94,537,611
FIRE	1,257,343	1,345,408	1,361,588	1,197,436	5,161,775
Service	3,940,716	4,853,058	6,630,999	4,116,935	19,541,708
Govt	0	0	0	0	0
Total	29,570,495	36,281,566	40,235,626	32,782,140	138,869,827

Table 3.6

Kenai Construction Permitting

Kenai 4th QUARTER Permit VALUES by Type - 1998-2004 - in \$								
	1998	1999	2000	2001	2002	2003	2004	Annual Change
Residential - New	416,000	702,000	376,000	324,000	377,000	779,000	482,000	-38.1%
Residential - Add/Alter	43,800	221,400	55,400	67,800	70,000	183,000	27,000	-85.2%
Commercial - New	49,000	125,000	244,000	214,000	990,000	253,000	0	-100.0%
Commercial - Add/Alter	86,500	8,600	2,800	49,500	90,800	1,240,500	76,400	-93.8%
TOTAL	595,300	1,057,000	678,200	655,300	1,527,800	2,455,500	585,400	-76.2%
Annual Change		77.6%	-35.8%	-3.4%	133.1%	60.7%	-76.2%	

Table 3.7

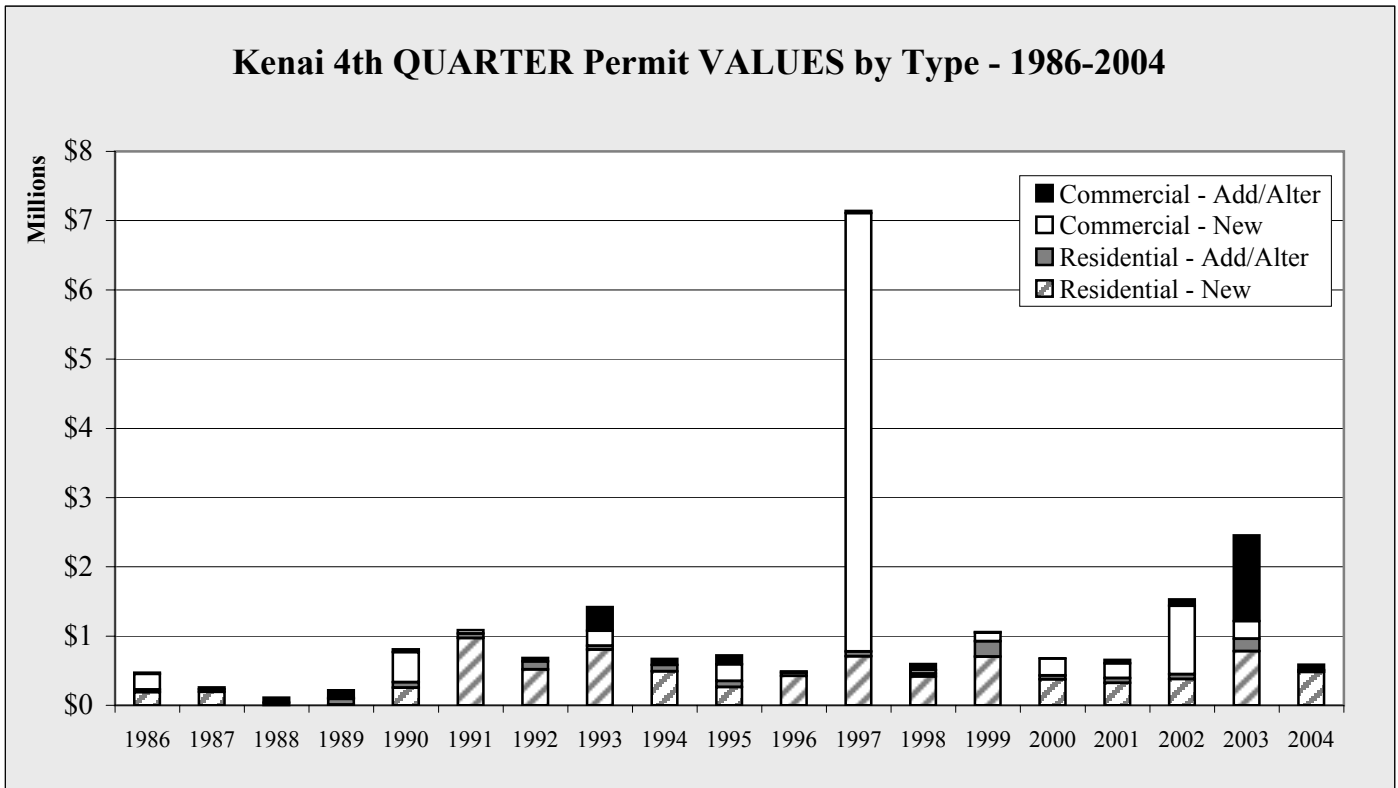

Chart 3.9

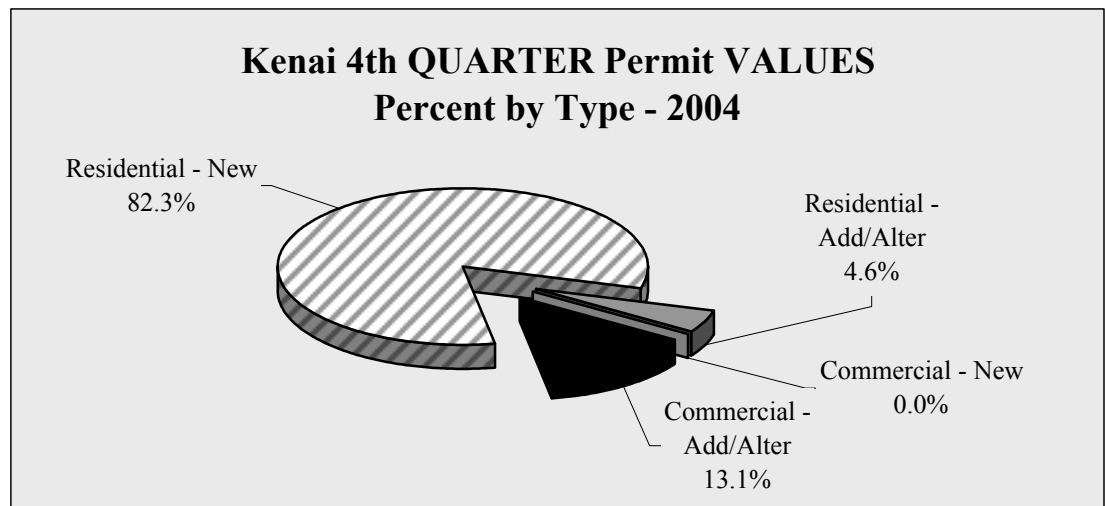

Chart 3.10

Kenai Construction Permitting

Kenai 4th QUARTER Permit VOLUME by Type - 1998-2004

	1998	1999	2000	2001	2002	2003	2004	Annual Change
Residential - New	3	7	3	2	3	6	4	-33.3%
Residential - Add/Alter	5	13	7	5	4	5	4	-20.0%
Commercial - New	2	1	2	1	3	2	0	-100.0%
Commercial - Add/Alter	8	1	1	3	10	8	6	-25.0%
TOTAL	18	22	13	11	20	21	14	-33.3%
Annual Change		22.2%	-40.9%	-15.4%	81.8%	5.0%	-33.3%	

Table 3.8

Kenai 4th QUARTER Permit VOLUME by Type - 1986-2004

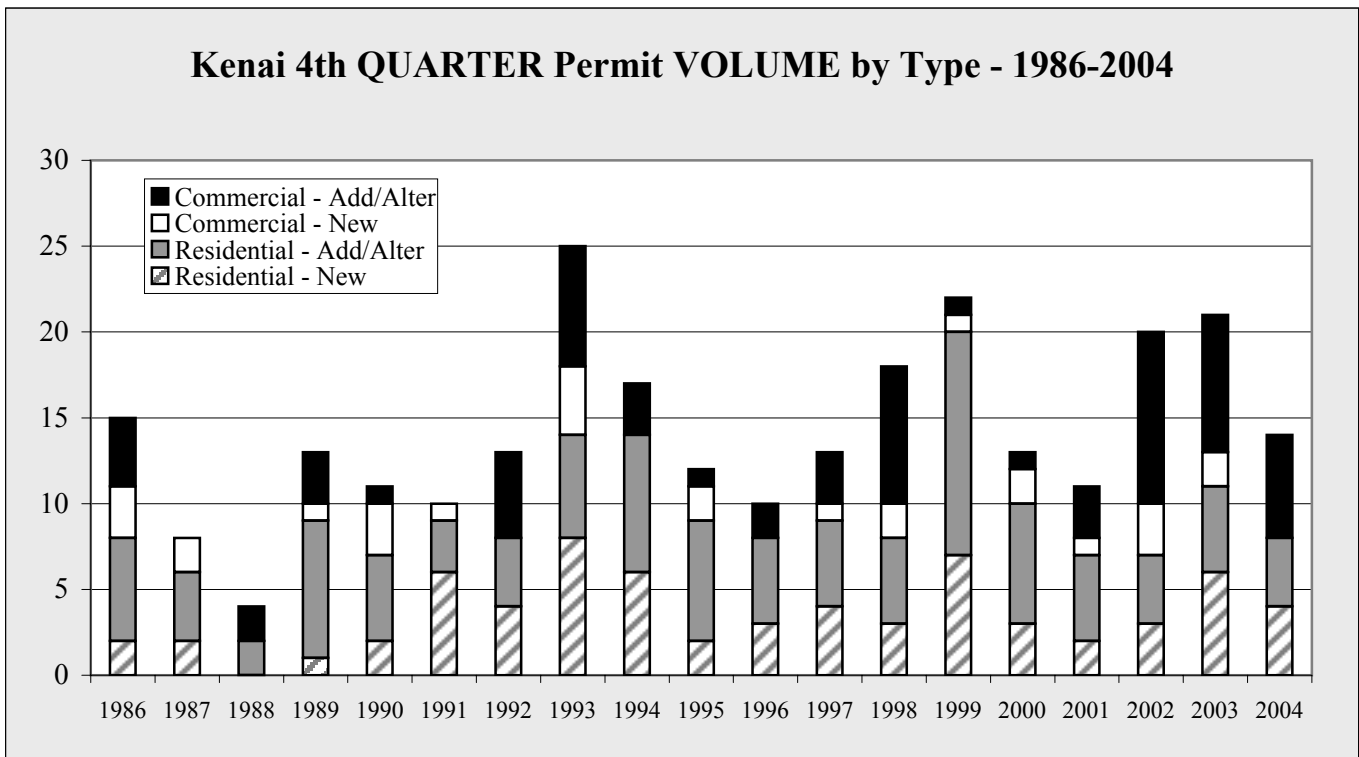

Chart 3.11

**Kenai 4th QUARTER Permit VOLUME
Percent by Type - 2004**

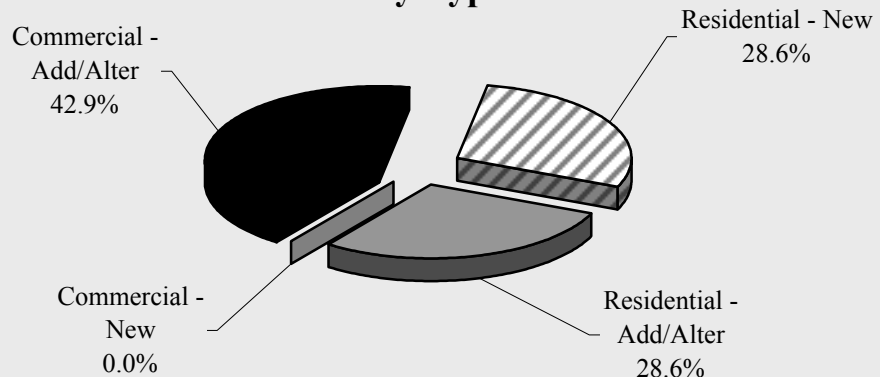

Chart 3.12

Kenai Construction Permitting

Kenai ANNUAL Permit VALUES by Type - 1998-2004 - in \$								
	1998	1999	2000	2001	2002	2003	2004	Annual Change
Residential - New	6,033,500	3,324,000	3,497,000	4,985,000	5,917,000	3,282,000	3,058,500	-6.8%
Residential - Add/Alter	730,700	798,000	888,400	675,100	723,500	882,050	400,150	-54.6%
Commercial - New	151,000	4,797,750	4,250,000	5,379,700	6,261,200	304,000	331,000	8.9%
Commercial - Add/Alter	727,000	522,000	762,700	2,539,100	3,897,700	5,973,750	996,900	-83.3%
TOTAL	7,642,200	9,441,750	9,398,100	13,578,900	16,799,400	10,441,800	4,786,550	-54.2%
Annual Change		23.5%	-0.5%	44.5%	23.7%	-37.8%	-54.2%	

Table 3.9

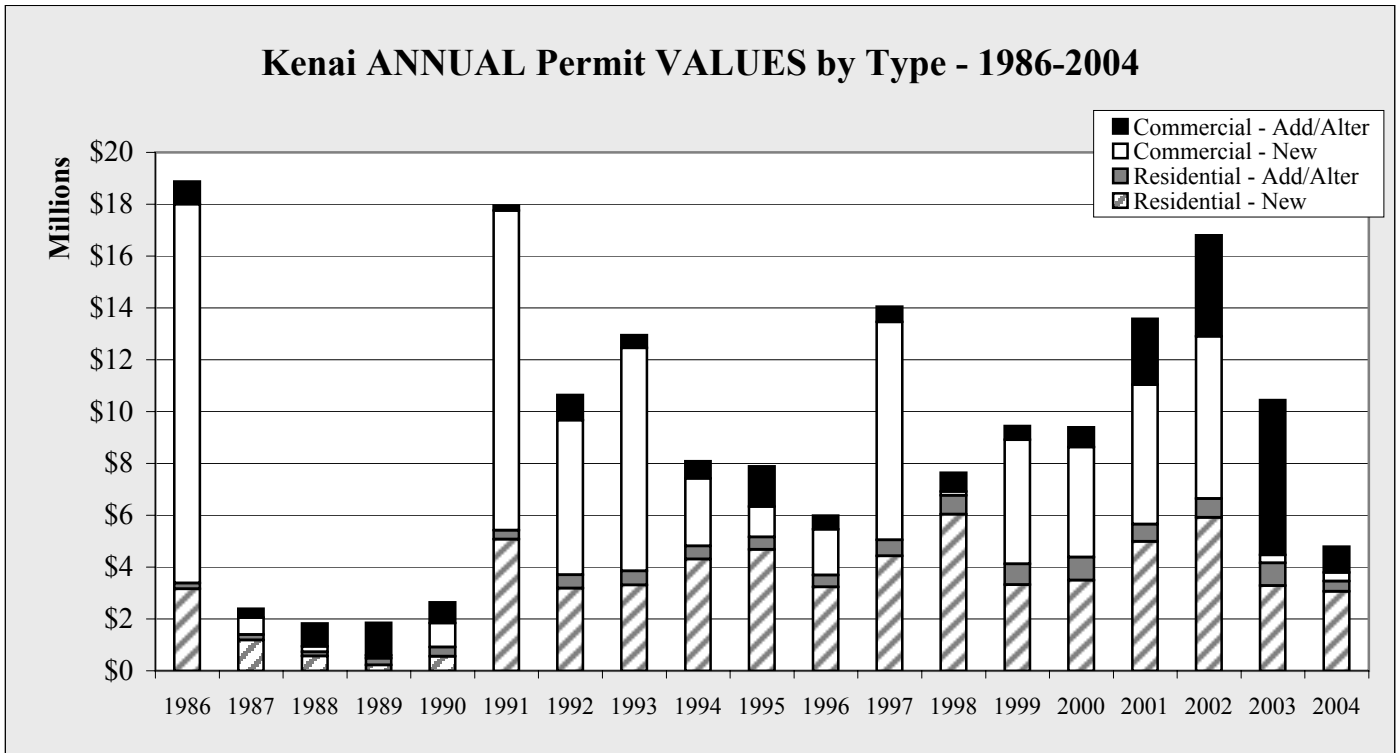

Chart 3.13

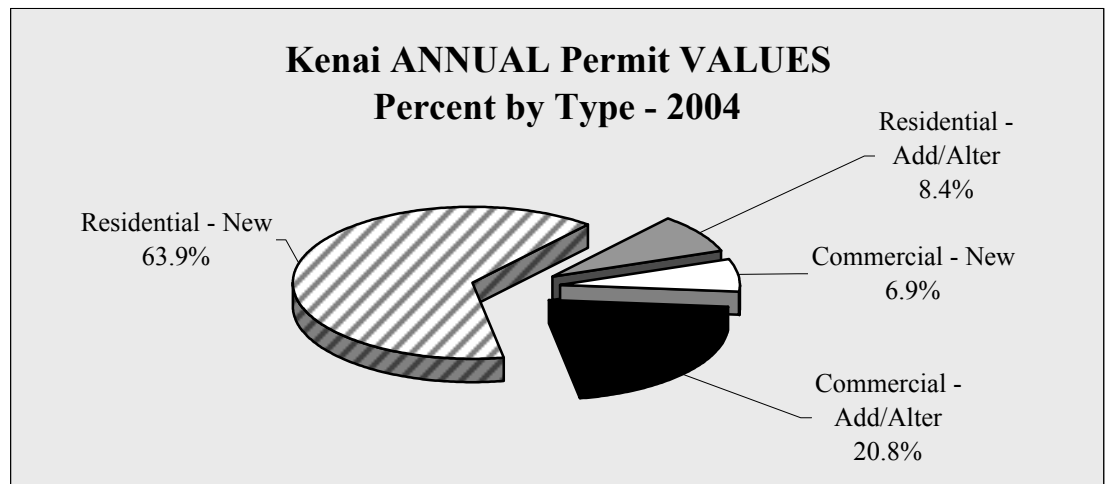

Chart 3.14

Kenai Construction Permitting

Kenai ANNUAL Permit VOLUME by Type - 1998-2004 - in \$								
	1998	1999	2000	2001	2002	2003	2004	Annual Change
Residential - New	45	26	26	30	42	22	20	-9.1%
Residential - Add/Alter	33	41	45	31	45	44	25	-43.2%
Commercial - New	4	13	11	8	9	4	3	-25.0%
Commercial - Add/Alter	15	22	11	18	25	44	31	-29.5%
TOTAL	97	102	93	87	121	114	79	-30.7%
Annual Change		5.2%	-8.8%	-6.5%	39.1%	-5.8%	-30.7%	

Table 3.10

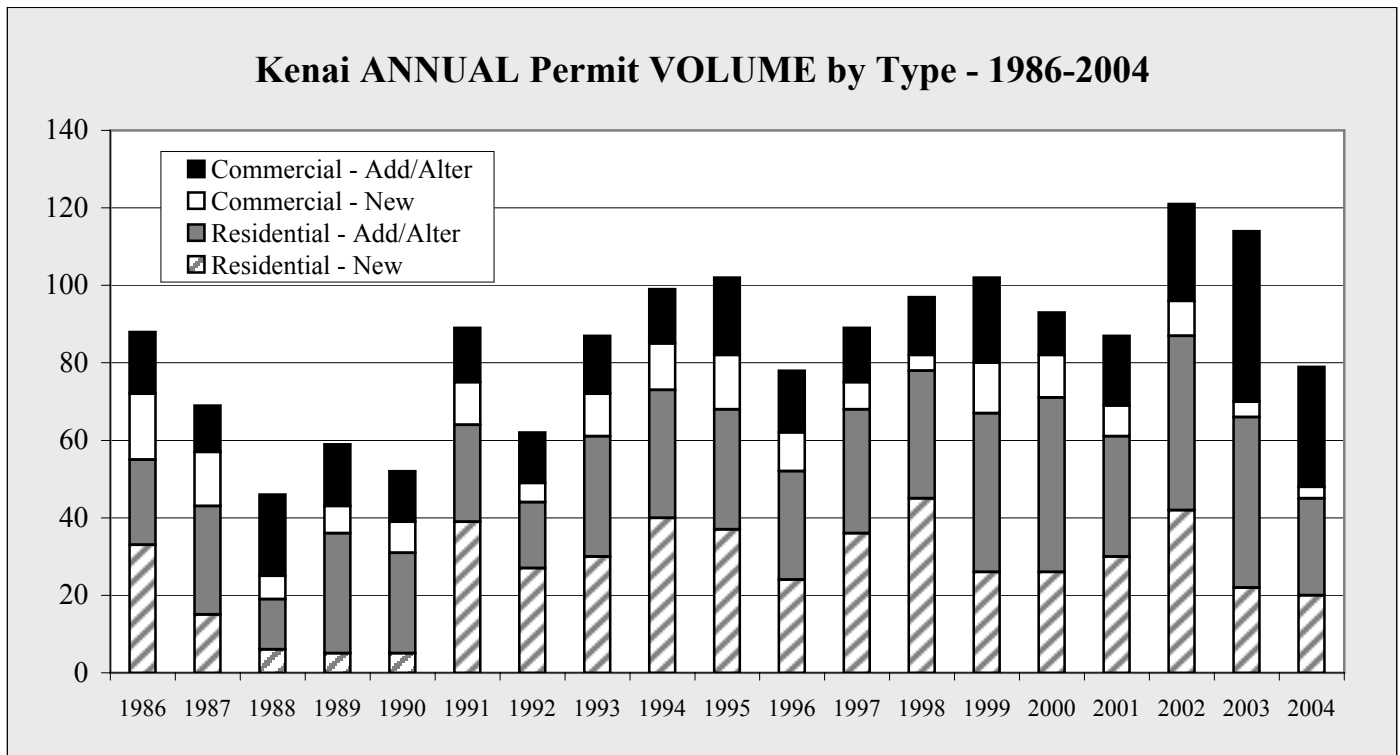

Chart 3.15

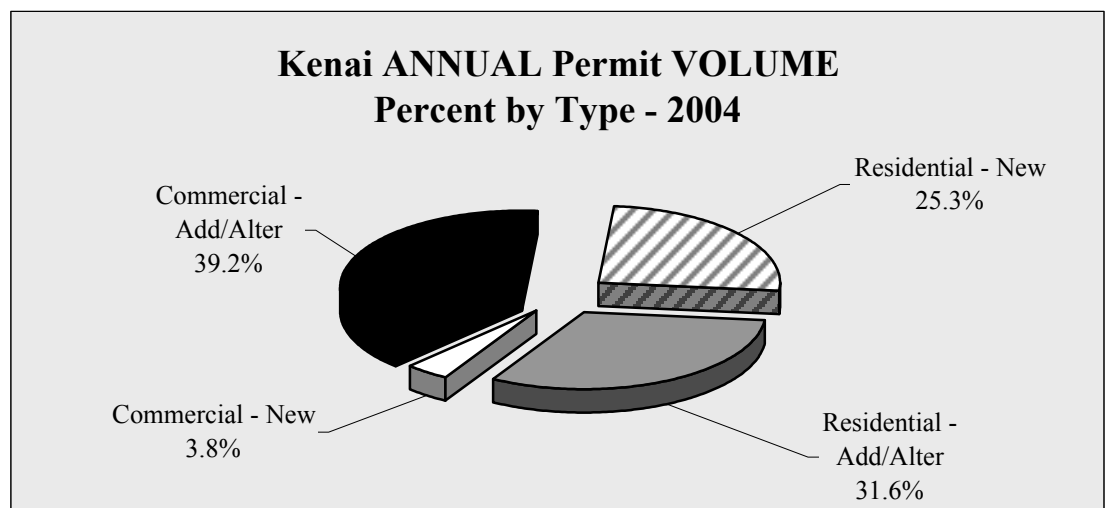

Chart 3.16

Kenai Construction Permitting

Kenai Annual Permit VALUES by Type by Quarter - 1997-2004 - in \$					
	1st Quarter	2nd Quarter	3rd Quarter	4th Quarter	Total
1997					
Residential - New	431,900	2,368,600	923,000	705,000	4,428,500
Residential - Add/Alter	45,000	329,800	181,000	69,200	625,000
Commercial - New	0	1,462,000	605,000	6,332,000	8,399,000
Commercial - Add/Alter	0	115,000	453,500	32,550	601,050
TOTAL	476,900	4,275,400	2,162,500	7,138,750	14,053,550
1998					
Residential - New	208,500	3,884,500	1,524,500	416,000	6,033,500
Residential - Add/Alter	68,500	495,500	122,900	43,800	730,700
Commercial - New	7,000	0	95,000	49,000	151,000
Commercial - Add/Alter	186,500	21,500	432,500	86,500	727,000
TOTAL	470,500	4,401,500	2,174,900	595,300	7,642,200
1999					
Residential - New	0	1,573,000	1,049,000	702,000	3,324,000
Residential - Add/Alter	122,000	187,600	267,000	221,400	798,000
Commercial - New	14,500	61,000	4,597,250	125,000	4,797,750
Commercial - Add/Alter	103,000	201,000	209,400	8,600	522,000
TOTAL	239,500	2,022,600	6,122,650	1,057,000	9,441,750
2000					
Residential - New	228,000	1,606,000	1,287,000	376,000	3,497,000
Residential - Add/Alter	7,000	439,000	387,000	55,400	888,400
Commercial - New	65,000	1,045,000	2,896,000	244,000	4,250,000
Commercial - Add/Alter	162,900	73,000	524,000	2,800	762,700
TOTAL	462,900	3,163,000	5,094,000	678,200	9,398,100
2001					
Residential - New	623,000	2,886,000	1,152,000	324,000	4,985,000
Residential - Add/Alter	161,500	228,300	217,500	67,800	675,100
Commercial - New	15,000	3,744,000	1,406,700	214,000	5,379,700
Commercial - Add/Alter	20,000	739,600	1,730,000	49,500	2,539,100
TOTAL	819,500	7,597,900	4,506,200	655,300	13,578,900
2002					
Residential - New	279,000	2,362,000	2,899,000	377,000	5,917,000
Residential - Add/Alter	28,000	323,100	302,400	70,000	723,500
Commercial - New	3,579,200	1,480,000	212,000	990,000	6,261,200
Commercial - Add/Alter	2,000	404,300	3,400,600	90,800	3,897,700
TOTAL	3,888,200	4,569,400	6,814,000	1,527,800	16,799,400
2003					
Residential - New	0	1,943,000	560,000	779,000	3,282,000
Residential - Add/Alter	15,000	515,200	168,850	183,000	882,050
Commercial - New	0	0	51,000	253,000	304,000
Commercial - Add/Alter	1,542,600	270,150	2,920,500	1,240,500	5,973,750
TOTAL	1,557,600	2,728,350	3,700,350	2,455,500	10,441,800
2004					
Residential - New	300,000	1,079,000	1,197,500	482,000	3,058,500
Residential - Add/Alter	12,000	52,200	308,950	27,000	400,150
Commercial - New	0	81,000	250,000	0	331,000
Commercial - Add/Alter	0	685,200	235,300	76,400	996,900
TOTAL	312,000	1,897,400	1,991,750	585,400	4,786,550

Table 3.11

Kenai Construction Permitting

Kenai Annual Permit VOLUME by Type by Quarter - 1997-2004					
	1st Quarter	2nd Quarter	3rd Quarter	4th Quarter	Total
1997					
Residential - New	4	21	7	4	36
Residential - Add/Alter	2	15	10	5	32
Commercial - New	0	5	1	1	7
Commercial - Add/Alter	0	1	10	3	14
TOTAL	6	42	28	13	89
1998					
Residential - New	2	27	13	3	45
Residential - Add/Alter	5	10	13	5	33
Commercial - New	1	0	1	2	4
Commercial - Add/Alter	2	2	3	8	15
TOTAL	10	39	30	18	97
1999					
Residential - New	0	12	7	7	26
Residential - Add/Alter	3	13	12	13	41
Commercial - New	1	1	10	1	13
Commercial - Add/Alter	3	7	11	1	22
TOTAL	7	33	40	22	102
2000					
Residential - New	1	11	11	3	26
Residential - Add/Alter	2	18	18	7	45
Commercial - New	1	4	4	2	11
Commercial - Add/Alter	4	3	3	1	11
TOTAL	8	36	36	13	93
2001					
Residential - New	4	16	8	2	30
Residential Add/Alter	5	13	8	5	31
Commercial - New	1	3	3	1	8
Commercial - Add/Alter	1	10	4	3	18
TOTAL	11	42	23	11	87
2002					
Residential - New	2	18	19	3	42
Residential Add/Alter	1	14	26	4	45
Commercial - New	1	3	2	3	9
Commercial - Add/Alter	1	2	12	10	25
TOTAL	5	37	59	20	121
2003					
Residential - New	0	13	3	6	22
Residential Add/Alter	1	16	22	5	44
Commercial - New	0	0	2	2	4
Commercial - Add/Alter	7	11	18	8	44
TOTAL	8	40	45	21	114
2004					
Residential - New	3	5	8	4	20
Residential Add/Alter	1	8	12	4	25
Commercial - New	0	2	1	0	3
Commercial - Add/Alter	0	15	10	6	31
TOTAL	4	30	31	14	79

Table 3.12

Kenai Cost of Food Survey

Cost of food data is collected by the University of Alaska, Fairbanks Cooperative Extension. Each quarter the Cooperative Extension surveys up to three grocers in communities throughout the state to determine the cost of food for one week. Specific guidelines are presented to the surveyors regarding item size and sale price for 104 items. It has been determined that separation of Kenai and Soldotna data would be meaningless therefore data presented relates to both communities.

KENAI/SOLDOTNA									
	Dec-97	Dec-98	Dec-99	Dec-00	Dec-01	Dec-02	Dec 03	Dec-04	Annual Change
Sales Tax (in percent)	5.0	5.0	5.0	5.0	5.0	5.0	5.0	5.0	
Percent of Food Unavailable	0.0	0.0	0.0	0.0	0.0	1.0	0.0	0.0	
Child, 1 year	15.60	16.15	16.16	16.34	17.91	17.78	19.25	17.56	-8.8%
Child, 2 years	0.00	0.00	0.00	0.00	17.91	17.78	18.88	17.56	-7.0%
Children 3-5 years of age	17.10	17.60	17.69	17.92	19.66	19.53	20.73	19.31	-6.8%
Children 6-8 years of age	22.69	23.50	23.52	23.87	26.11	26.03	27.88	25.68	-7.9%
Children 9-11 years of age	25.79	26.57	26.66	27.06	29.63	29.50	31.32	29.09	-7.1%
Males 12-14 years of age	29.16	29.99	30.13	30.49	33.51	33.32	35.30	32.94	-6.7%
Males 15-19 years of age	30.06	30.84	30.97	31.41	34.57	34.37	36.36	33.98	-6.5%
Males 20-50 years of age	29.84	30.67	30.80	31.24	34.39	34.29	36.46	33.80	-7.3%
Males 51 and older	28.52	29.22	29.28	29.83	32.72	32.62	34.95	32.05	-8.3%
Females 12-19 years of age	25.11	25.89	25.89	26.31	28.91	28.72	30.63	28.38	-7.3%
Females 20-50 years of age	26.21	26.83	26.82	27.39	29.97	29.94	31.85	29.43	-7.6%
Females 51 and older	25.39	26.06	26.15	26.64	29.28	29.16	30.98	28.64	-7.6%
Family of 2, 20-50 years of age	61.66	63.22	63.38	64.49	70.79	70.65	75.14	69.56	-7.4%
Family of 2, 51 years and older	59.30	60.83	61.01	62.11	68.20	67.97	72.53	66.76	-8.0%
Family of 4, children 1-5 years	88.74	91.25	91.48	92.89	101.92	101.54	107.93	100.10	-7.3%
Family of 4, children 6-11 years	104.52	107.57	107.81	109.57	122.09	119.76	127.52	118.00	-7.5%
Electricity, 1000 kWh	111.00	120.65	119.34	113.17	122.05	126.11	113.87	118.37	4.0%
Gasoline, auto, 55 gal	76.95	73.87	79.75	97.35	80.12	89.10	100.65	87.45	-13.1%
Lumber, 2X4X8'	3.76	3.10	3.69	3.26	3.13	3.28	2.92	3.40	16.4%
Propane, 100 lb. refill	39.48	36.68	37.52	42.24	43.42	43.42	48.14	43.42	-9.8%
Sewer & Water, monthly	41.29	41.00	NA	NA	NA	NA	NA	NA	NA

Table 3.13

Kenai Cost of Food Survey

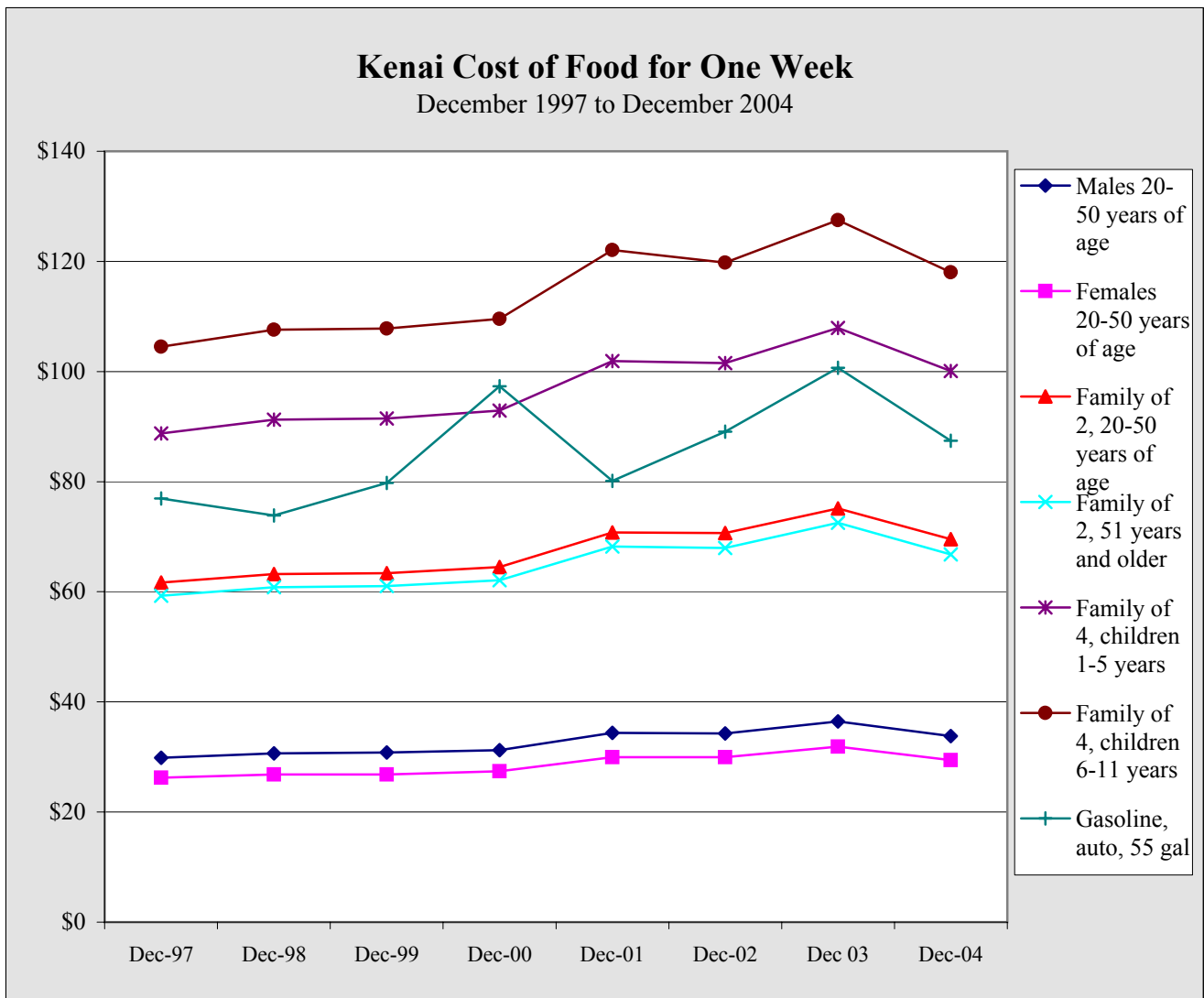

Chart 3.17

Seldovia Sales

Seldovia 4th Quarter GROSS Sales by Industry - 1998-2004 - in \$								
	1998	1999	2000	2001	2002	2003	2004	Annual Change
AFF	0	0	0	0	0	0	0	NA
Min	0	0	0	0	0	0	0	NA
Const	46,027	52,918	106,917	44,531	39,968	736,642	706,248	-4.1%
Manu	8,489	2,796	10,400	983	31,523	2,645	1,793	-32.2%
TCPU	168,998	163,821	150,395	147,266	152,323	188,812	149,278	-20.9%
Whole	191,909	18,179	11,724	6,241	7,553	45,855	34,554	-24.6%
Retail	332,135	512,713	520,994	563,281	526,121	540,761	630,990	16.7%
FIRE	35,041	16,623	15,364	10,134	56,170	250,503	1,407,888	462.0%
Service	90,102	74,288	80,303	147,365	143,278	184,091	198,456	7.8%
Total	872,701	841,338	896,097	919,801	956,936	1,949,309	3,129,207	60.5%
Annual Change		-3.6%	6.5%	2.6%	4.0%	103.7%	60.5%	

Table 4.1

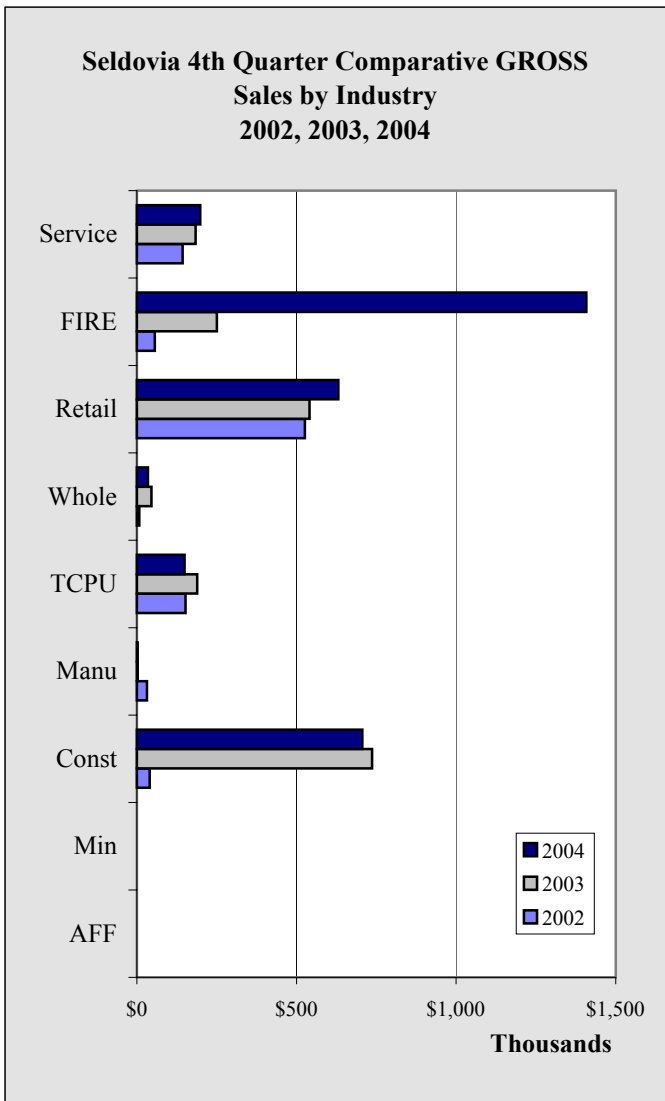

Chart 4.1

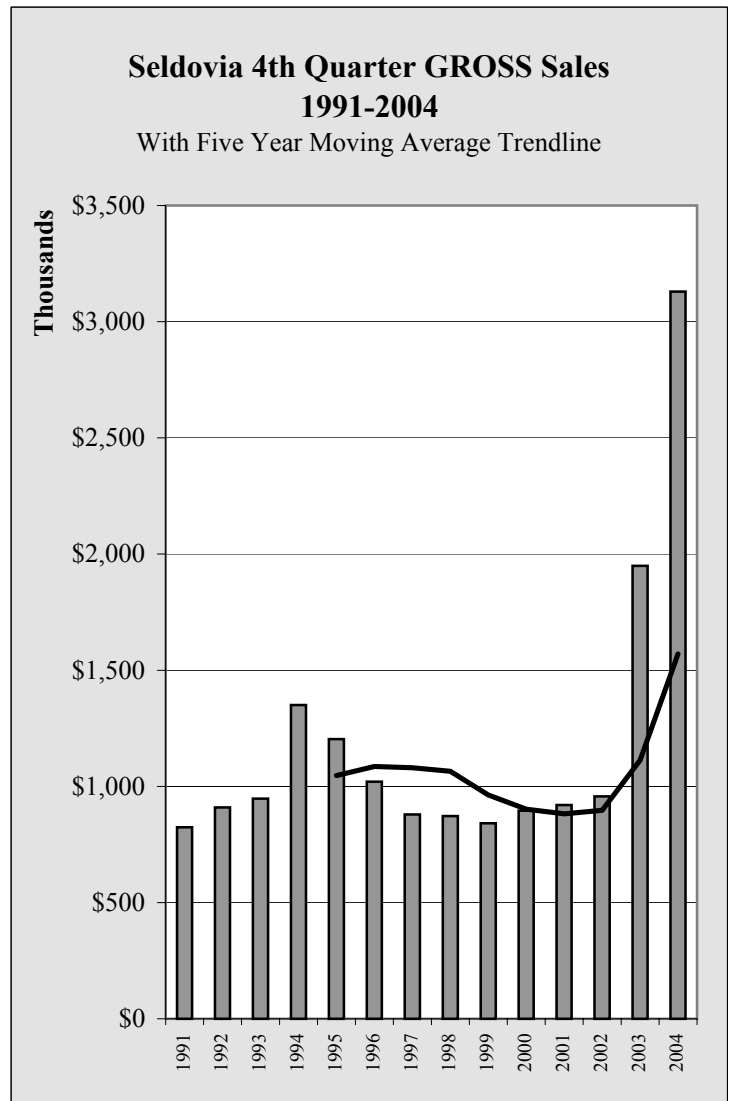

Chart 4.2

Seldovia Sales

Seldovia 4th Quarter TAXABLE Sales by Industry - 1998-2004 - in \$								
	1998	1999	2000	2001	2002	2003	2004	Annual Change
AFF	0	0	0	0	0	0	0	NA
Min	0	0	0	0	0	0	0	NA
Const	11,526	12,058	10,356	7,289	1,022	8,871	6,350	-28.4%
Manu	7,719	945	1,808	474	2,854	945	1,398	47.9%
TCPU	105,593	116,071	106,202	93,267	111,111	142,862	91,234	-36.1%
Whole	112,153	3,405	1,059	1,098	0	538	128	NA
Retail	299,456	397,537	405,260	426,019	406,403	426,146	462,952	8.6%
FIRE	20,155	10,983	7,025	7,644	4,080	7,983	16,739	109.7%
Service	60,055	58,223	57,957	76,375	82,476	87,344	110,233	26.2%
Total	616,657	599,222	589,667	612,166	607,946	674,689	689,034	2.1%
Annual Change		-2.8%	-1.6%	3.8%	-0.7%	11.0%	2.1%	

Table 4.2

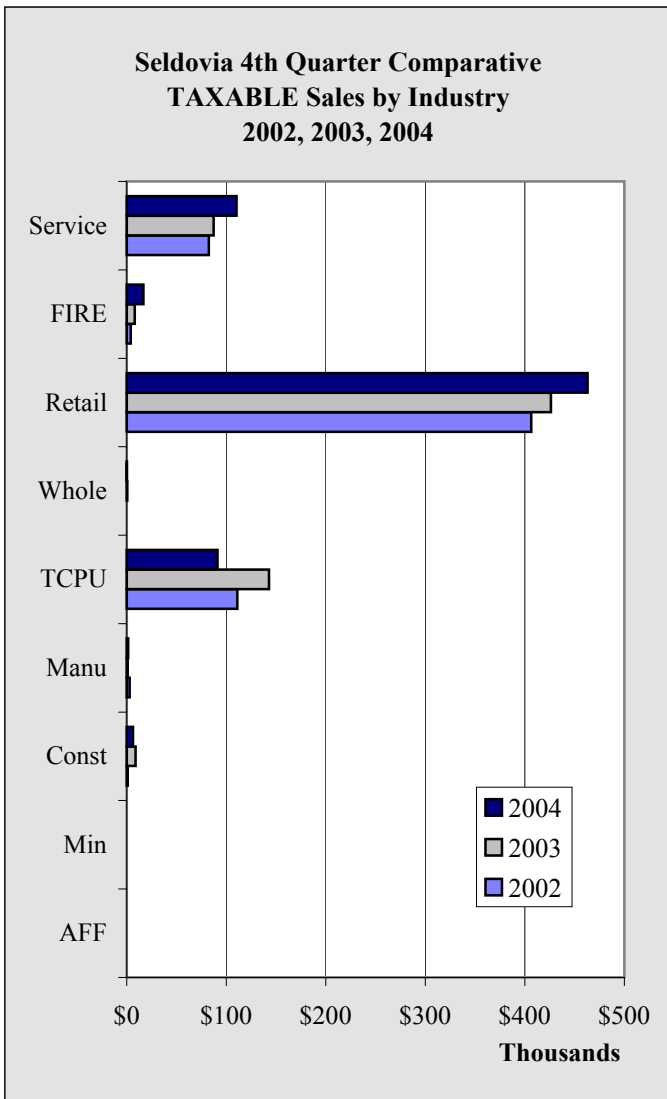

Chart 4.3

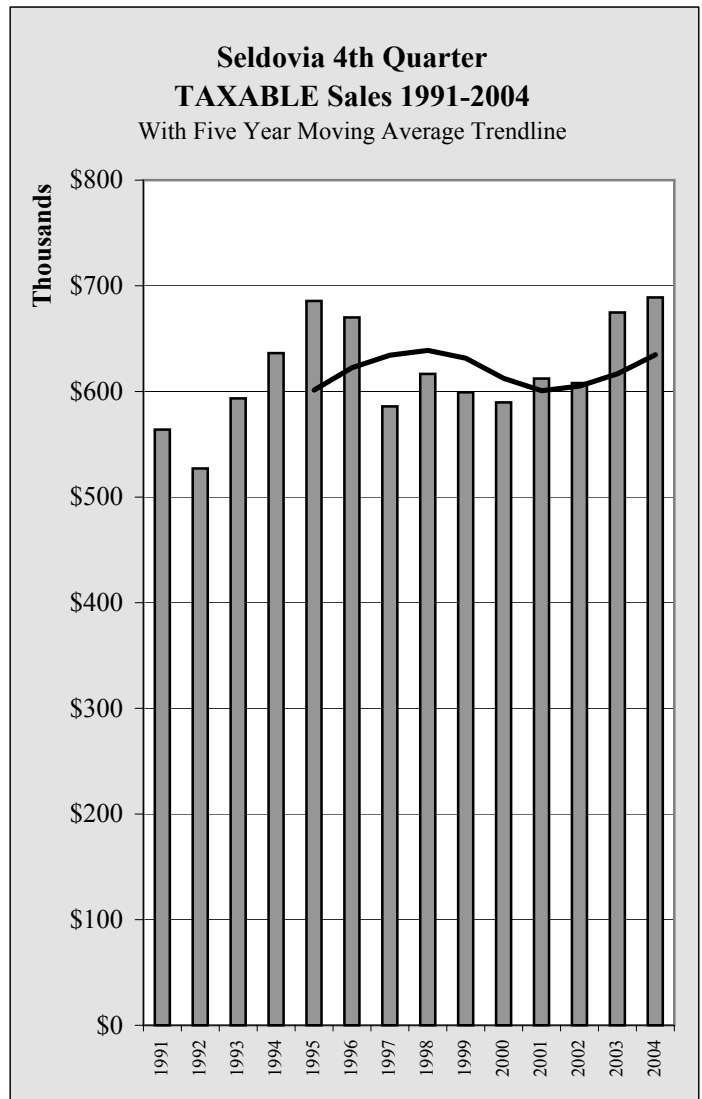

Chart 4.4

Seldovia Sales

Seldovia Annual GROSS Sales by Industry - 1998-2004 - in \$								
	1998	1999	2000	2001	2002	2003	2004	Annual Change
AFF	3,422	3,084	2,797	3,787	6,306	5,737	28,760	401.3%
Min	0	0	0	0	0	0	0	NA
Const	302,999	200,475	567,881	427,249	233,790	2,235,069	2,432,152	8.8%
Manu	53,202	142,303	22,483	40,983	41,694	44,136	24,563	-44.3%
TCPU	724,009	702,895	642,067	615,305	589,101	609,377	621,624	2.0%
Whole	886,557	466,249	74,511	58,140	40,755	143,974	105,348	-26.8%
Retail	1,698,659	2,359,533	2,969,768	2,710,711	2,527,071	2,565,299	2,638,392	2.8%
FIRE	134,421	111,959	62,750	509,244	443,797	590,854	1,441,632	144.0%
Service	920,470	858,272	925,068	884,052	935,363	1,065,108	2,369,846	122.5%
Total	4,723,739	4,844,770	5,267,325	5,249,471	4,817,877	7,259,554	9,662,317	33.1%
Annual Change		2.6%	8.7%	-0.3%	-8.2%	50.7%	33.1%	

Table 4.3

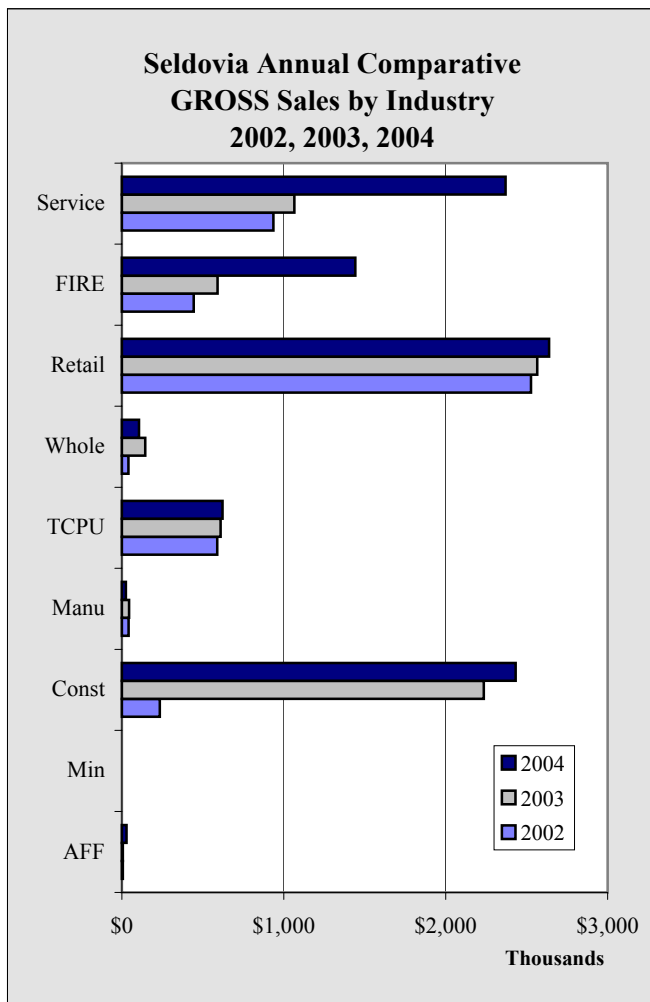

Chart 4.5

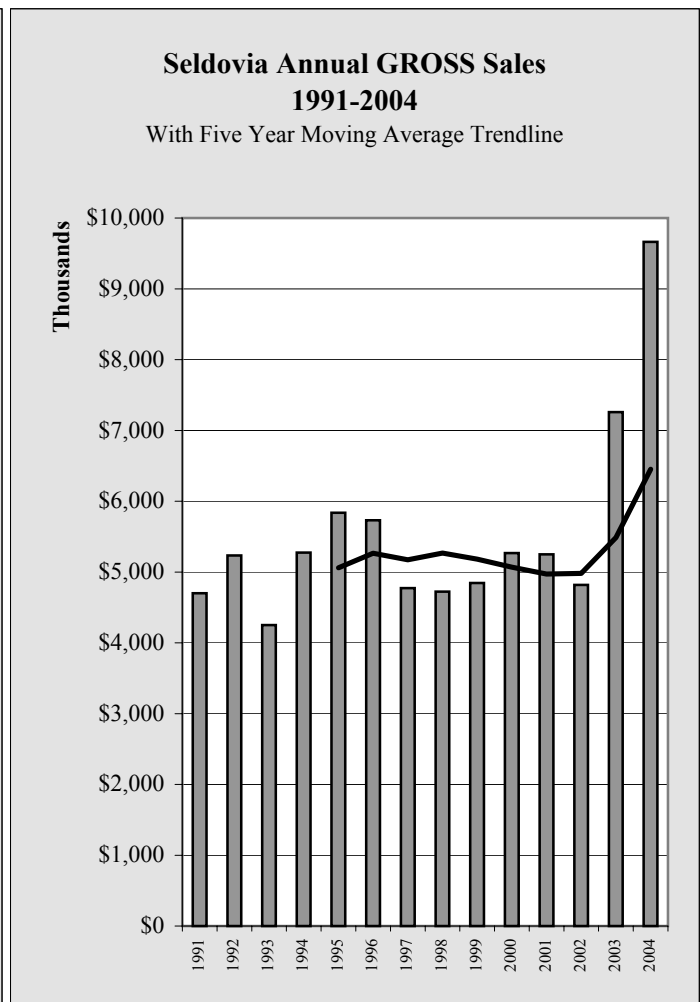

Chart 4.6

Seldovia Sales

Seldovia Annual TAXABLE Sales by Industry - 1998-2004 - in \$								
	1998	1999	2000	2001	2002	2003	2004	Annual Change
AFF	3,422	3,084	2,771	3,616	3,551	2,970	3,140	5.7%
Min	0	0	0	0	0	0	0	NA
Const	32,244	37,757	41,098	34,175	22,683	26,848	27,088	0.9%
Manu	16,711	7,035	4,892	4,818	6,509	9,098	9,146	0.5%
TCPU	438,292	473,005	455,499	410,584	427,667	450,291	411,317	-8.7%
Whole	510,369	106,422	4,692	4,069	945	1,649	426	-74.2%
Retail	1,577,816	1,877,036	2,165,560	2,226,879	2,118,927	2,155,556	2,167,489	0.6%
FIRE	83,118	65,347	28,771	31,657	24,937	29,796	41,810	40.3%
Service	736,321	659,563	714,840	643,481	667,170	700,736	717,071	2.3%
Total	3,398,293	3,229,249	3,418,123	3,359,279	3,272,389	3,376,944	3,377,487	0.02%
Annual Change		-5.0%	5.8%	-1.7%	-2.6%	3.2%	0.02%	

Table 4.4

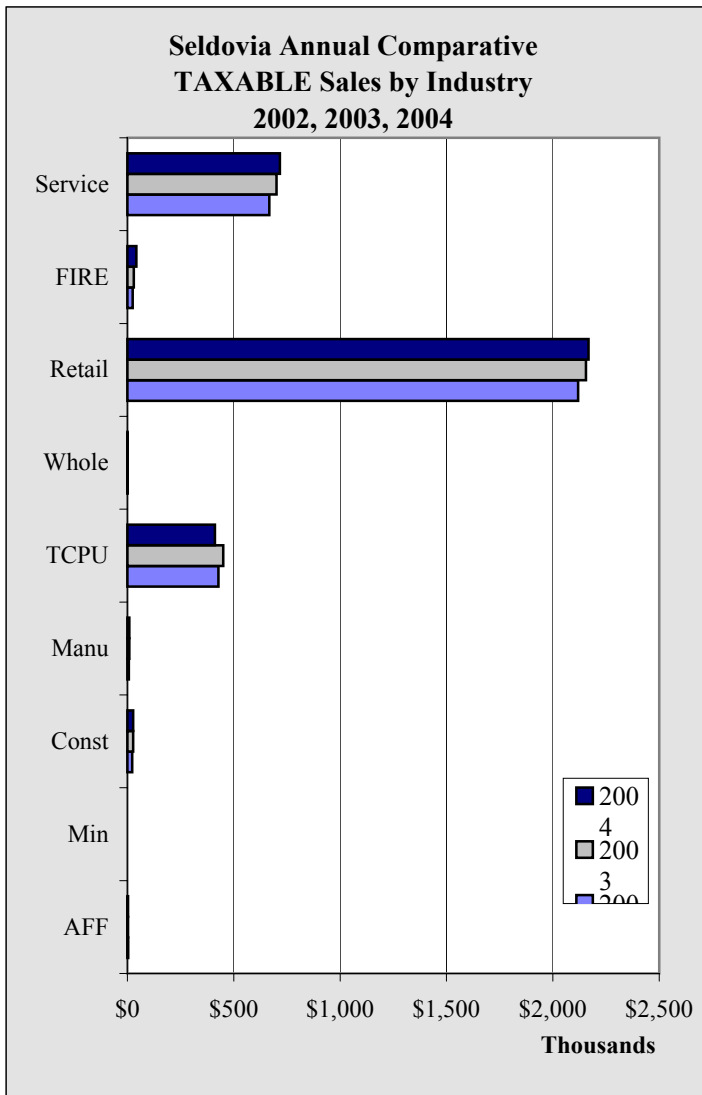

Chart 4.7

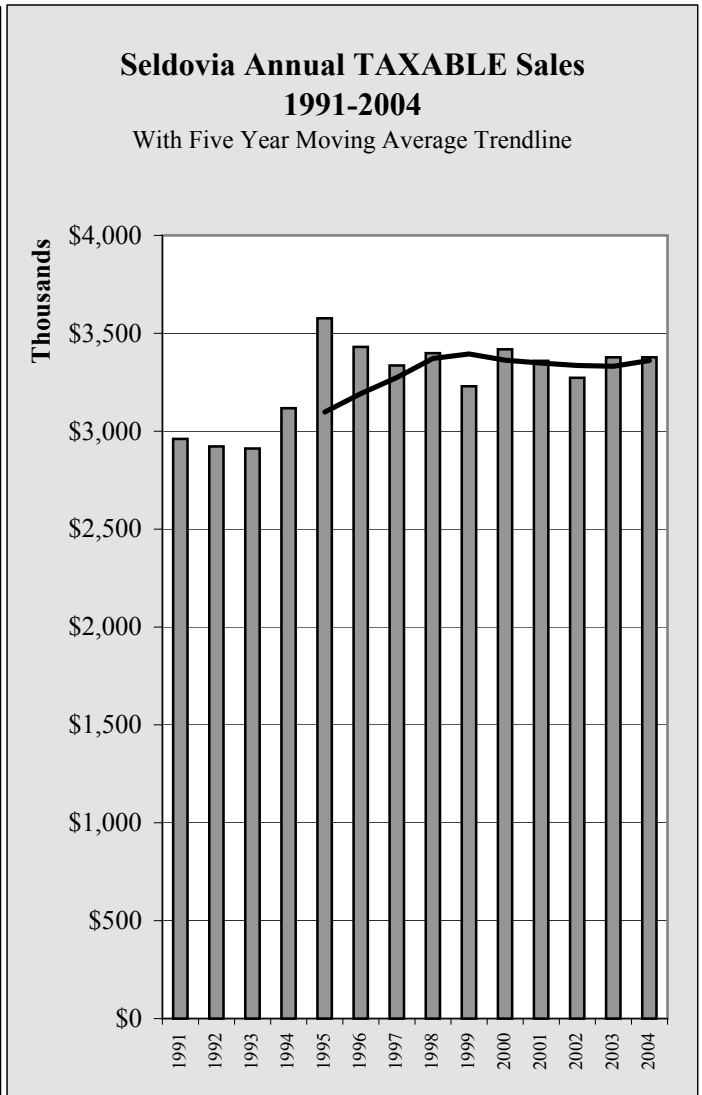

Chart 4.8

Seldovia Sales

Seldovia GROSS Sales by Industry by Quarter - 2000-2004 - in \$					
	1st Quarter	2nd Quarter	3rd Quarter	4th Quarter	Total
2000					
AFF	0	2,797	0	0	2,797
Min	0	0	0	0	0
Const	46,844	248,864	165,256	106,917	567,881
Manu	3,729	6,644	1,710	10,400	22,483
TCPU	159,367	163,062	169,243	150,395	642,067
Whole	16,761	22,656	23,370	11,724	74,511
Retail	807,661	752,524	888,589	520,994	2,969,768
FIRE	14,063	24,750	8,573	15,364	62,750
Service	102,267	305,603	436,895	80,303	925,068
Total	1,150,692	1,526,900	1,693,636	896,097	5,267,325
2001					
AFF	0	3,707	80	0	3,787
Min	0	0	0	0	0
Const	30,023	287,028	65,667	44,531	427,249
Manu	2,989	14,430	22,581	983	40,983
TCPU	162,024	138,629	167,386	147,266	615,305
Whole	25,686	13,490	12,723	6,241	58,140
Retail	553,396	758,967	835,067	563,281	2,710,711
FIRE	23,824	17,006	458,280	10,134	509,244
Service	100,869	240,048	395,770	147,365	884,052
Total	898,811	1,473,305	1,957,554	919,801	5,249,471
2002					
AFF	0	6,306	0	0	6,306
Min	0	0	0	0	0
Const	66,782	42,719	84,321	39,968	233,790
Manu	1,704	5,911	2,556	31,523	41,694
TCPU	163,245	136,379	137,154	152,323	589,101
Whole	3,760	7,040	22,402	7,553	40,755
Retail	485,479	690,215	825,256	526,121	2,527,071
FIRE	158,668	8,734	220,225	56,170	443,797
Service	132,074	257,751	402,260	143,278	935,363
Total	1,011,712	1,155,055	1,694,174	956,936	4,817,877
2003					
AFF	0	5,737	0	0	5,737
Min	0	0	0	0	0
Const	27,947	213,775	1,256,705	736,642	2,235,069
Manu	1,845	25,326	14,320	2,645	44,136
TCPU	147,749	135,580	137,236	188,812	609,377
Whole	9,201	17,477	71,441	45,855	143,974
Retail	544,320	711,358	768,860	540,761	2,565,299
FIRE	7,090	242,188	91,073	250,503	590,854
Service	108,853	278,014	494,150	184,091	1,065,108
Total	847,005	1,629,455	2,833,785	1,949,309	7,259,554
2004					
AFF	0	11,260	17,500	0	28,760
Min	0	0	0	0	0
Const	601,376	763,635	360,893	706,248	2,432,152
Manu	1,249	8,735	12,786	1,793	24,563
TCPU	151,748	152,078	168,520	149,278	621,624
Whole	14,150	26,237	30,407	34,554	105,348
Retail	522,637	722,686	762,079	630,990	2,638,392
FIRE	9,127	10,170	14,447	1,407,888	1,441,632
Service	1,000,312	728,643	442,435	198,456	2,369,846
Total	2,300,599	2,423,444	1,809,067	3,129,207	9,662,317

Table 4.5

Seldovia Sales

Seldovia TAXABLE Sales by Industry by Quarter - 2000-2004 - in \$					
	1st Quarter	2nd Quarter	3rd Quarter	4th Quarter	Total
2000					
AFF	0	2,771	0	0	2,771
Min	0	0	0	0	0
Const	9,989	11,054	9,699	10,356	41,098
Manu	1,709	867	508	1,808	4,892
TCPU	110,305	118,630	120,362	106,202	455,499
Whole	1,003	2,227	403	1,059	4,692
Retail	369,861	631,517	758,922	405,260	2,165,560
FIRE	8,593	8,996	4,157	7,025	28,771
Service	67,633	242,193	347,057	57,957	714,840
Total	569,093	1,018,255	1,241,108	589,667	3,418,123
2001					
AFF	0	3,616	0	0	3,616
Min	0	0	0	0	0
Const	7,595	9,498	9,793	7,289	34,175
Manu	1,054	1,243	2,047	474	4,818
TCPU	117,188	94,825	105,304	93,267	410,584
Whole	250	1,305	1,416	1,098	4,069
Retail	392,049	657,146	751,665	426,019	2,226,879
FIRE	6,389	7,434	10,190	7,644	31,657
Service	59,030	180,966	327,110	76,375	643,481
Total	583,555	956,033	1,207,525	612,166	3,359,279
2002					
AFF	0	3,551	0	0	3,551
Min	0	0	0	0	0
Const	6,980	9,130	5,551	1,022	22,683
Manu	1,194	1,806	655	2,854	6,509
TCPU	115,021	95,299	106,236	111,111	427,667
Whole	159	135	651	0	945
Retail	367,416	590,349	754,759	406,403	2,118,927
FIRE	7,178	6,144	7,535	4,080	24,937
Service	75,676	192,416	316,602	82,476	667,170
Total	573,624	898,830	1,191,989	607,946	3,272,389
2003					
AFF	0	2,970	0	0	2,970
Min	0	0	0	0	0
Const	1,131	9,946	6,900	8,871	26,848
Manu	368	1,749	6,036	945	9,098
TCPU	103,692	96,701	107,036	142,862	450,291
Whole	150	321	640	538	1,649
Retail	415,056	620,851	693,503	426,146	2,155,556
FIRE	4,600	9,430	7,783	7,983	29,796
Service	73,973	220,998	318,421	87,344	700,736
Total	598,970	962,966	1,140,319	674,689	3,376,944
2004					
AFF	0	3,140	0	0	3,140
Min	0	0	0	0	0
Const	5,160	8,058	7,520	6,350	27,088
Manu	649	2,135	4,964	1,398	9,146
TCPU	96,989	105,084	118,010	91,234	411,317
Whole	30	137	131	128	426
Retail	392,241	613,360	698,936	462,952	2,167,489
FIRE	5,942	8,540	10,589	16,739	41,810
Service	65,715	199,135	341,988	110,233	717,071
Total	566,726	939,589	1,182,138	689,034	3,377,487

Table 4.6

Seldovia Construction Permitting

Seldovia 4th Quarter Permit Values by Type - 1998-2004 - in \$							
	1998	1999	2000	2001	2002	2003	2004
Residential - New	0	0	0	0	0	26,000	0
Residential - Add/Alter	0	5,000	5,000	5,000	20,000	3,000	0
Commercial - New	0	0	0	0	0	7,500	0
Commercial - Add/Alter	0	13,000	0	10,000	0	0	0
TOTAL	0	18,000	5,000	15,000	20,000	36,500	0
Annual Change			-72.2%	200.0%	33.3%	82.5%	

Table 4.7

Seldovia 4th Quarter Permit Volume by Type - 1998-2004							
	1998	1999	2000	2001	2002	2003	2004
Residential - New	0	1	2	1	2	1	0
Residential - Add/Alter	0	4	3	4	2	0	0
Commercial - New	0	1	0	0	0	3	0
Commercial - Add/Alter	0	1	1	0	0	1	0
TOTAL	0	7	6	5	4	5	0
Annual Change		NA	-14.3%	-16.7%	-20.0%	25.0%	NA

Table 4.8

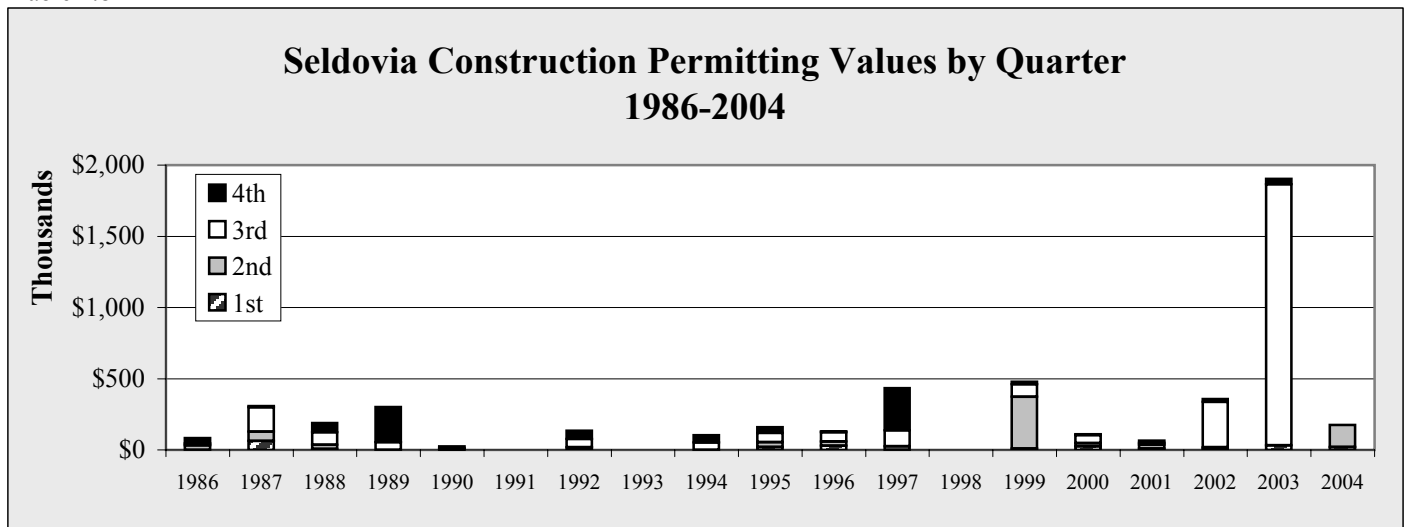

Chart 4.9

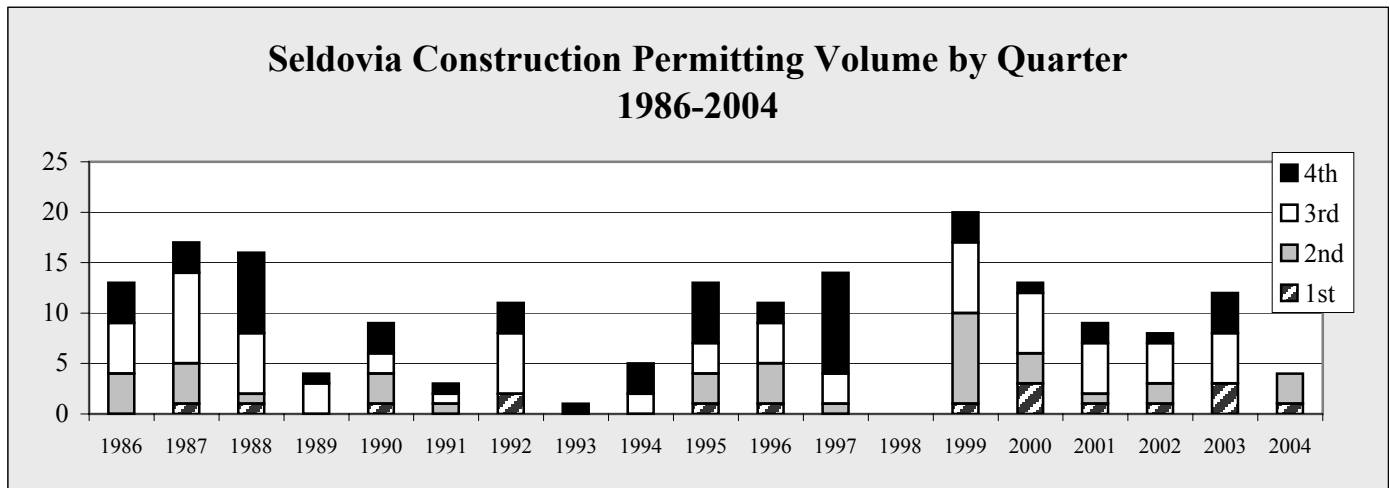

Chart 4.10

Seldovia Construction Permitting

Seldovia Annual Permit Values by Type by Quarter - 1997-2004 - in \$					
	1st Quarter	2nd Quarter	3rd Quarter	4th Quarter	Total
1997					
Residential - New	0	25,000	60,000	250,000	335,000
Residential - Add/Alter	0	0	15,000	44,900	59,900
Commercial - New	0	0	38,000	0	38,000
Commercial - Add/Alter	0	0	0	0	0
TOTAL	0	25,000	113,000	294,900	432,900
1998					
Residential - New	0	0	0	0	0
Residential - Add/Alter	0	0	0	0	0
Commercial - New	0	0	0	0	0
Commercial - Add/Alter	0	0	0	0	0
TOTAL	0	0	0	0	0
1999					
Residential - New	0	105,000	55,000	0	160,000
Residential - Add/Alter	0	16,500	14,500	5,000	36,000
Commercial - New	8,000	244,000	12,000	0	264,000
Commercial - Add/Alter	0	0	6,000	13,000	19,000
TOTAL	8,000	365,500	87,500	18,000	479,000
2000					
Residential - New	18,000	8,000	19,000	0	45,000
Residential - Add/Alter	6,000	14,300	35,400	5,000	60,700
Commercial - New	0	0	0	0	0
Commercial - Add/Alter	0	0	3,500	0	3,500
TOTAL	24,000	22,300	57,900	5,000	109,200
2001					
Residential - New	0	25,000	10,000	0	35,000
Residential - Add/Alter	0	0	5,525	5,000	10,525
Commercial - New	0	0	0	0	0
Commercial - Add/Alter	10,000	0	0	10,000	20,000
TOTAL	10,000	25,000	15,525	15,000	65,525
2002					
Residential - New	0	0	308,000	0	308,000
Residential - Add/Alter	10,000	8,000	10,500	20,000	48,500
Commercial - New	0	0	0	0	0
Commercial - Add/Alter	0	0	0	0	0
TOTAL	10,000	8,000	318,500	20,000	356,500
2003					
Residential - New	0	0	150,000	26,000	176,000
Residential - Add/Alter	31,000	0	0	3,000	34,000
Commercial - New	0	0	1,685,000	7,500	1,692,500
Commercial - Add/Alter	0	0	0	0	0
TOTAL	31,000	0	1,835,000	36,500	1,902,500
2004*					
Residential - New	20,000	150,000	0	0	170,000
Residential - Add/Alter	0	6,200	0	0	6,200
Commercial - New	0	0	0	0	0
Commercial - Add/Alter	0	0	0	0	0
TOTAL	20,000	156,200	0	0	176,200

Table 4.9

* - Seldovia did not issue any permits during 3rd or 4th quarter, 2004.

Seldovia Construction Permitting

Seldovia Annual Permit Volume by Type by Quarter - 1997-2004					
	1st Quarter	2nd Quarter	3rd Quarter	4th Quarter	Total
1997					
Residential - New	0	1	1	4	6
Residential - Add/Alter	0	0	1	6	7
Commercial - New	0	0	1	0	1
Commercial - Add/Alter	0	0	0	0	0
TOTAL	0	1	3	10	14
1998					
Residential - New	0	0	0	0	0
Residential - Add/Alter	0	0	0	0	0
Commercial - New	0	0	0	0	0
Commercial - Add/Alter	0	0	0	0	0
TOTAL	0	0	0	0	0
1999					
Residential - New	0	2	1	0	3
Residential - Add/Alter	0	4	4	1	9
Commercial - New	1	3	1	0	5
Commercial - Add/Alter	0	0	1	2	3
TOTAL	1	9	7	3	20
2000					
Residential - New	2	2	2	0	6
Residential - Add/Alter	1	1	3	1	6
Commercial - New	0	0	0	0	0
Commercial - Add/Alter	0	0	1	0	1
TOTAL	3	3	6	1	13
2001					
Residential - New	0	1	1	0	2
Residential Add/Alter	0	0	4	1	5
Commercial - New	0	0	0	0	0
Commercial - Add/Alter	1	0	0	1	2
TOTAL	1	1	5	2	9
2002					
Residential - New	0	0	2	0	2
Residential Add/Alter	1	2	2	1	6
Commercial - New	0	0	0	0	0
Commercial - Add/Alter	0	0	0	0	0
TOTAL	1	2	4	1	8
2003					
Residential - New	0	0	1	2	3
Residential Add/Alter	3	0	0	1	4
Commercial - New	0	0	3	1	4
Commercial - Add/Alter	0	0	1	0	1
TOTAL	3	0	5	4	12
2004*					
Residential - New	1	1	0	0	2
Residential Add/Alter	0	2	0	0	2
Commercial - New	0	0	0	0	0
Commercial - Add/Alter	0	0	0	0	0
TOTAL	1	3	0	0	4

Table 4.10

* - Seldovia did not issue any permits during 3rd or 4th quarter, 2004.

Seldovia Construction Permitting

This page intentionally left blank.

Seward Sales

Seward 4th Quarter GROSS Sales by Industry - 1998-2004 - in \$								
	1998	1999	2000	2001	2002	2003	2004	Annual Change
AFF	90,340	31,488	40,523	58,049	24,693	39,444	77,769	97.2%
Min	31,075	66,592	40,697	32,041	63,985	23,151	35,416	NA
Const	6,384,946	2,311,393	7,398,448	1,824,093	3,456,899	5,696,421	16,717,558	193.5%
Manu	697,604	1,302,849	2,623,829	1,838,613	2,450,766	2,726,812	861,235	-68.4%
TCPU	2,803,354	2,239,802	2,865,153	2,276,587	2,174,323	2,369,763	2,304,768	-2.7%
Whole	906,662	396,641	387,717	382,240	394,120	644,189	1,298,948	101.6%
Retail	7,351,448	7,960,253	8,068,766	8,078,507	8,308,672	9,521,774	9,245,748	-2.9%
FIRE	2,189,494	1,822,797	2,116,406	1,494,179	986,236	1,987,789	2,189,044	10.1%
Service	3,572,072	4,115,849	4,248,827	4,519,045	4,446,394	4,325,071	5,830,750	34.8%
Total	24,026,995	20,247,664	27,790,366	20,503,354	22,306,088	27,334,414	38,561,236	41.1%
Annual Change		-15.7%	37.3%	-26.2%	8.8%	22.5%	41.1%	

Table 5.1

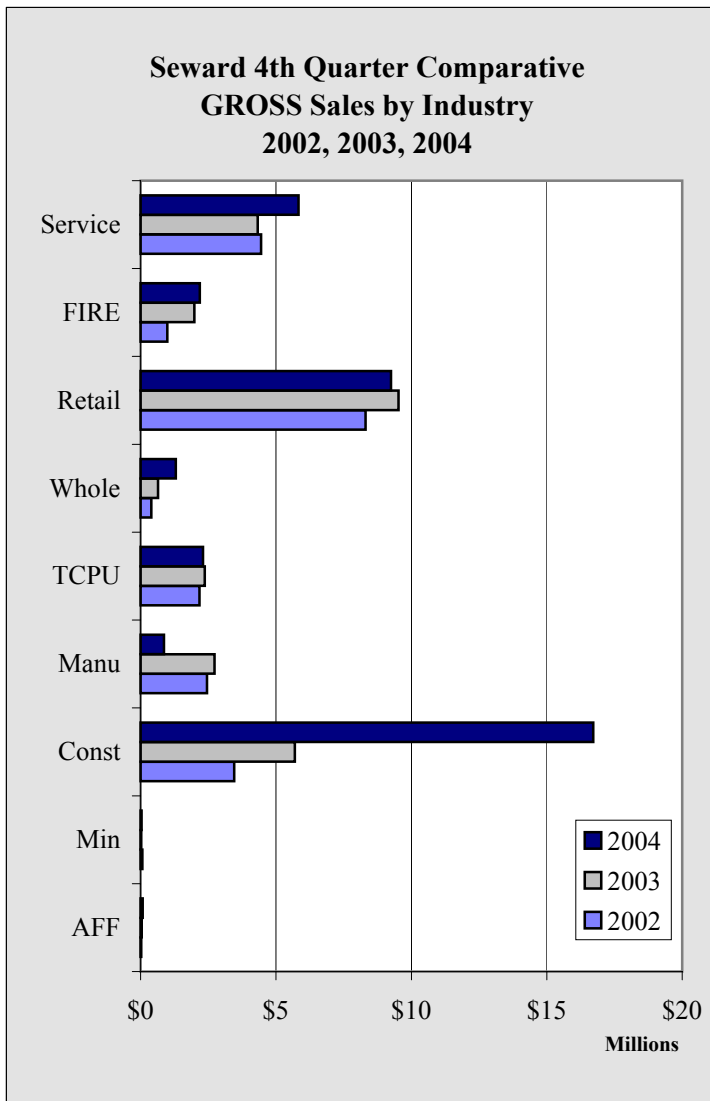

Chart 5.1

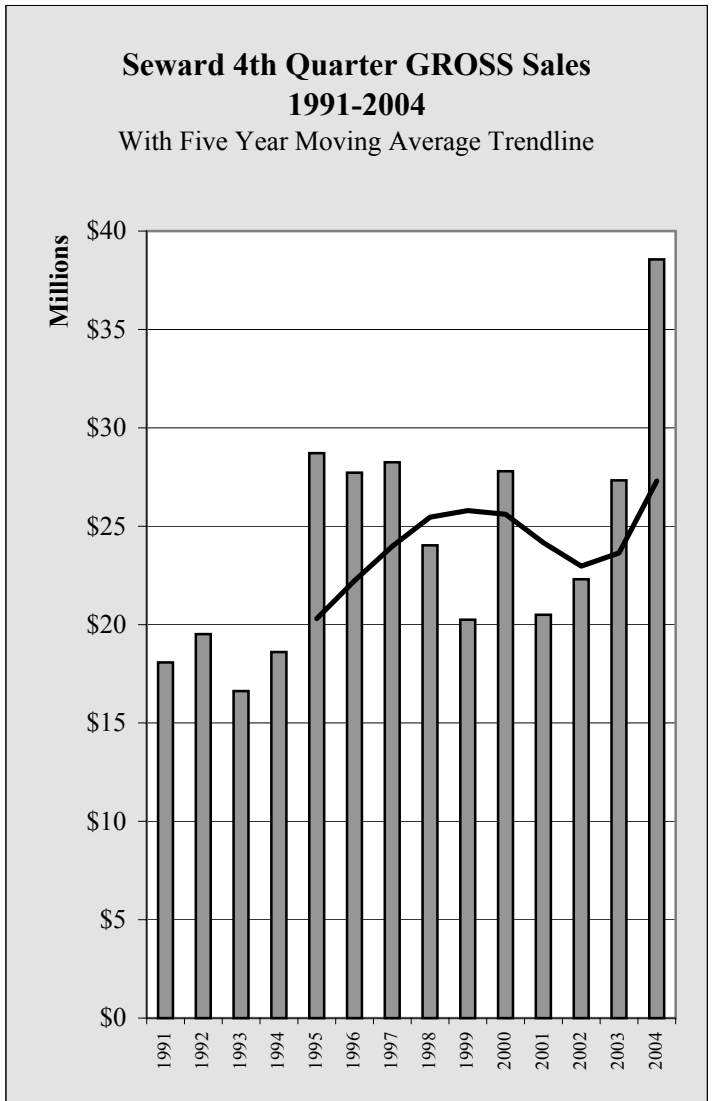

Chart 5.2

Seward Sales

Seward 4th Quarter TAXABLE Sales by Industry - 1998-2004 - in \$								
	1998	1999	2000	2001	2002	2003	2004	Annual Change
AFF	67,096	12,338	15,062	14,962	10,443	18,196	7,800	-57.1%
Min	221	0	0	0	0	0	0	NA
Const	193,391	185,092	153,961	130,990	140,292	192,071	184,187	-4.1%
Manu	106,966	124,731	166,712	122,911	122,143	143,810	132,142	-8.1%
TCPU	732,185	792,967	705,736	601,829	583,578	585,325	502,067	-14.2%
Whole	19,518	23,499	22,434	10,765	16,800	14,245	14,723	3.4%
Retail	5,533,848	5,784,732	6,117,114	5,975,227	6,006,749	6,306,836	6,399,411	1.5%
FIRE	359,515	351,635	394,429	386,891	343,944	316,440	328,059	3.7%
Service	2,759,859	3,282,273	2,969,247	2,763,926	2,809,169	2,720,011	2,706,081	-0.5%
Total	9,772,599	10,557,267	10,544,695	10,007,501	10,033,118	10,296,934	10,274,470	-0.2%
Annual Change		8.0%	-0.1%	-5.1%	0.3%	2.6%	-0.2%	

Table 5.2

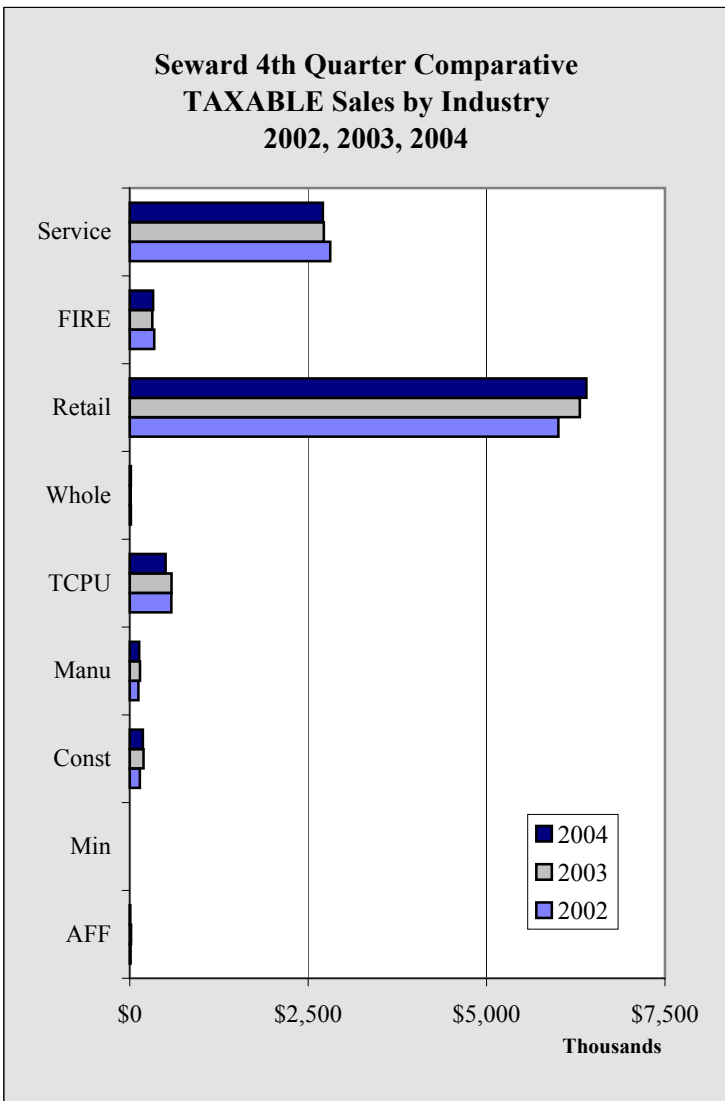

Chart 5.3

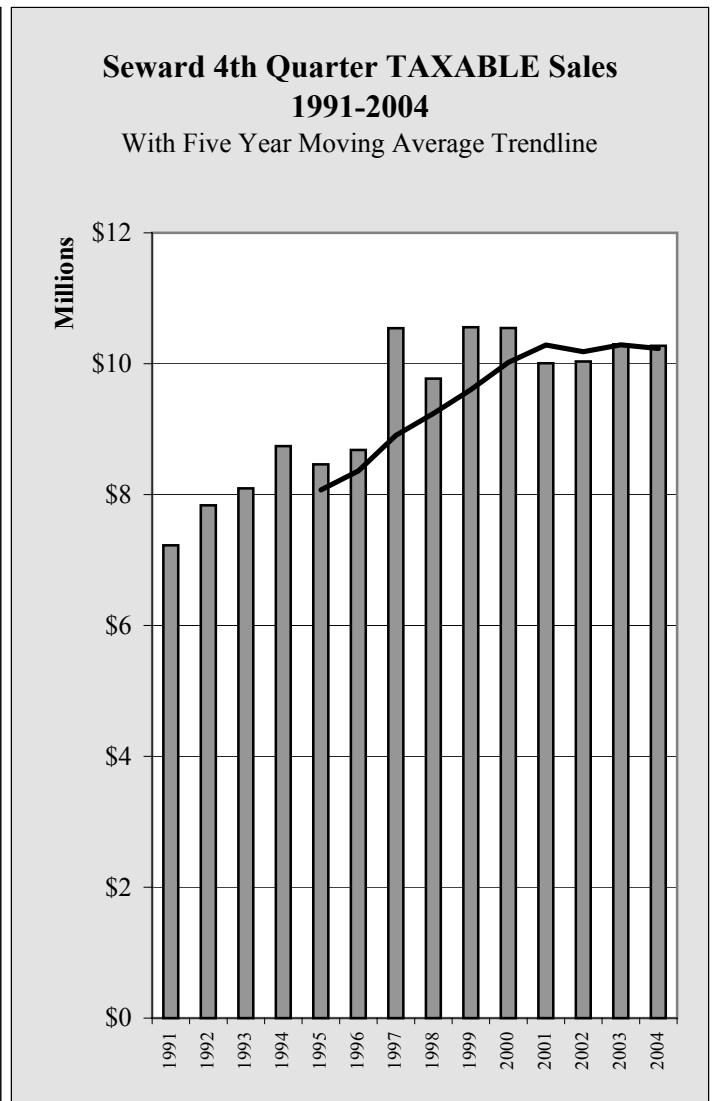

Chart 5.4

Seward Sales

Seward Annual GROSS Sales by Industry - 1998-2004 - in \$								
	1998	1999	2000	2001	2002	2003	2004	Annual Change
AFF	472,717	414,123	689,481	437,640	298,046	489,097	651,718	33.2%
Min	229,681	332,546	405,115	330,859	377,441	189,755	228,403	20.4%
Const	19,183,104	12,588,992	16,255,816	21,082,426	11,084,304	28,881,212	31,396,120	8.7%
Manu	4,266,551	4,895,971	9,541,307	12,023,577	11,540,635	10,446,881	7,190,947	-31.2%
TCPU	13,656,791	12,011,182	14,705,875	12,840,952	13,026,323	12,969,855	11,517,923	-11.2%
Whole	7,270,151	3,064,525	2,339,175	2,231,731	2,208,659	2,600,579	3,953,585	52.0%
Retail	44,656,247	48,356,132	51,460,505	50,408,318	52,600,754	53,593,021	59,902,713	11.8%
FIRE	8,498,546	9,458,188	8,394,110	6,333,381	7,595,826	7,557,129	7,775,271	2.9%
Service	34,272,460	39,033,862	38,360,895	42,671,669	43,635,138	40,232,069	44,731,649	11.2%
Total	132,506,248	130,155,521	142,152,279	148,360,553	142,367,126	156,959,598	167,348,329	6.6%
Annual Change		-1.8%	9.2%	4.4%	-4.0%	10.2%	6.6%	

Table 5.3

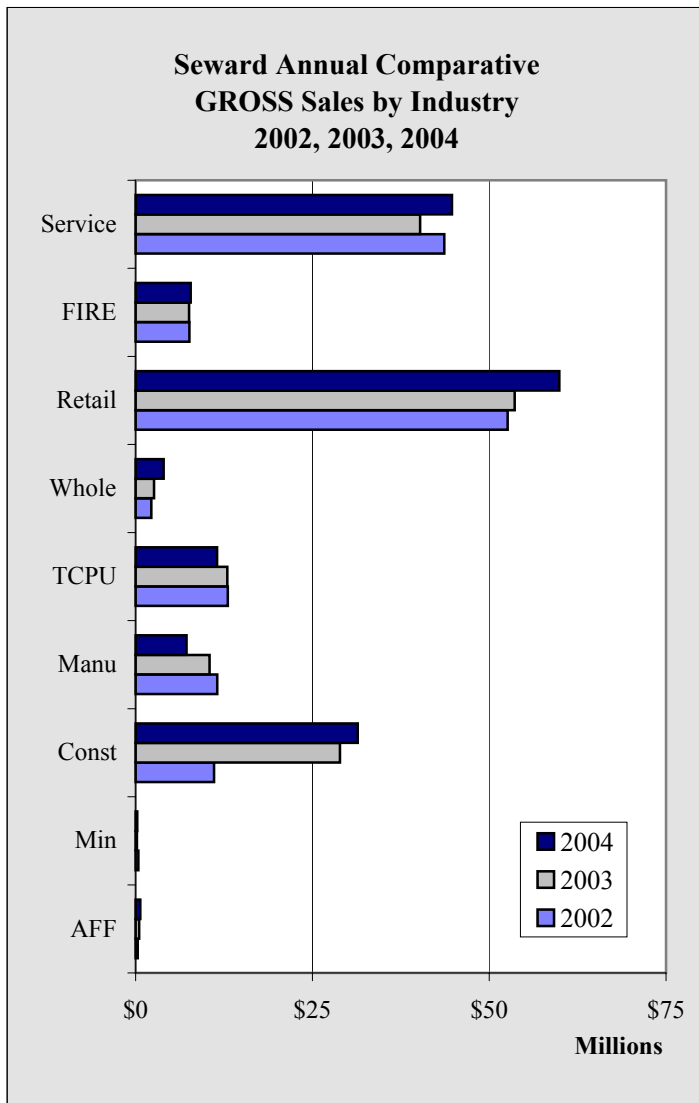

Chart 5.5

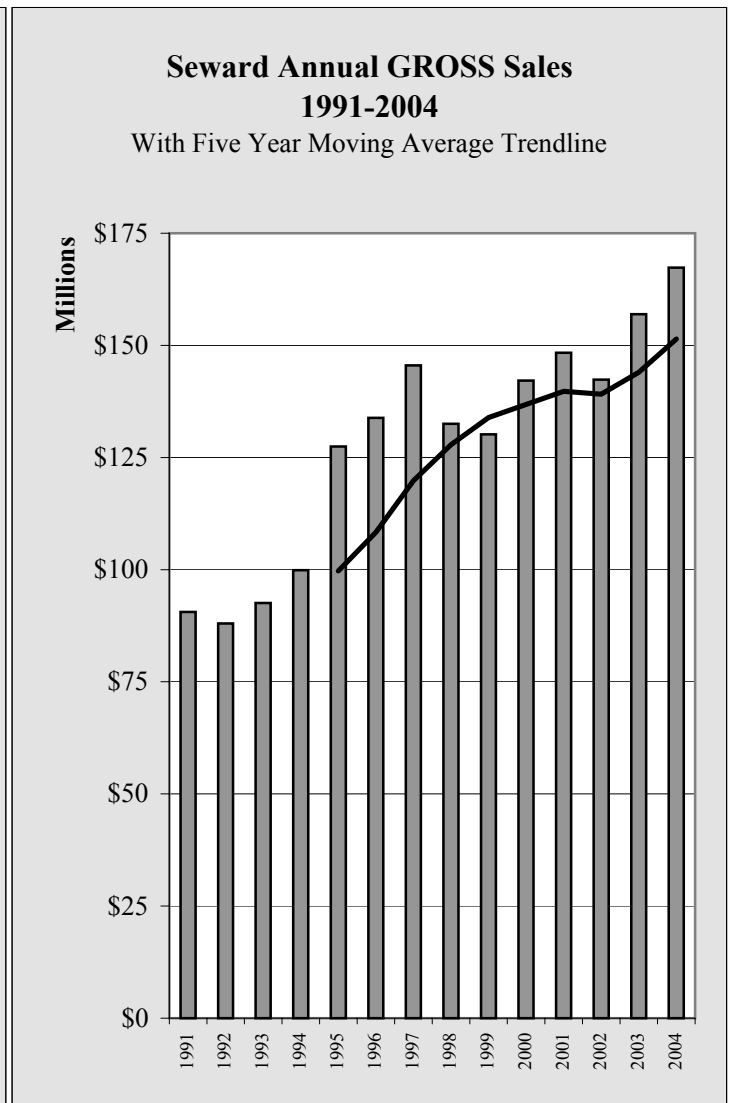

Chart 5.6

Seward Sales

Seward Annual TAXABLE Sales by Industry - 1998-2004 - in \$								
	1998	1999	2000	2001	2002	2003	2004	Annual Change
AFF	190,979	126,681	240,141	170,624	114,521	217,323	227,337	4.6%
Min	221	1,444	500	0	0	3,455	0	NA
Const	709,318	718,945	671,326	567,626	565,290	683,590	738,180	8.0%
Manu	505,430	585,005	639,366	962,382	988,659	629,648	590,158	-6.3%
TCPU	3,826,559	3,801,591	3,991,338	2,936,725	2,916,215	2,921,669	2,668,486	-8.7%
Whole	382,361	128,287	141,551	135,396	107,027	119,020	107,918	-9.3%
Retail	33,478,522	35,539,902	37,600,377	38,191,615	39,040,960	40,270,165	42,330,069	5.1%
FIRE	1,604,043	1,662,085	1,583,364	1,665,703	1,780,596	1,593,083	1,586,041	-0.4%
Service	26,580,831	28,908,259	29,115,463	29,595,520	30,085,428	29,937,785	31,391,735	4.9%
Total	67,278,264	71,472,199	73,983,426	74,225,591	75,598,696	76,375,738	79,639,924	4.3%
Annual Change		6.2%	3.5%	0.3%	1.8%	1.0%	4.3%	

Table 5.4

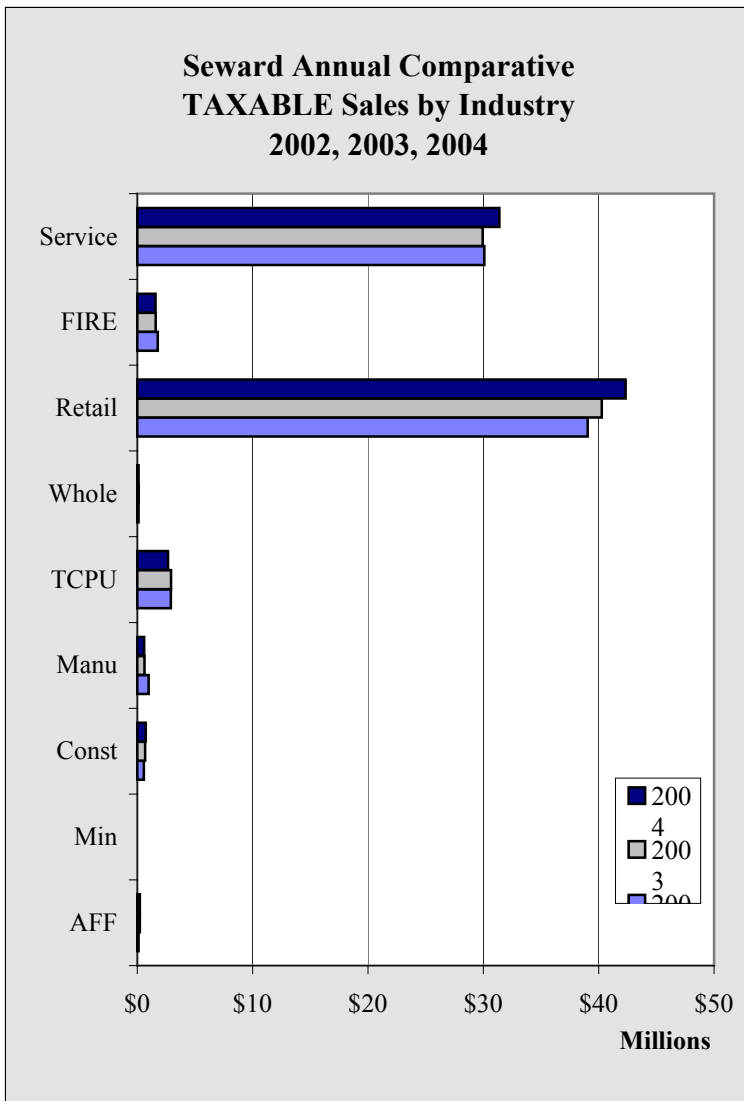

Chart 5.7

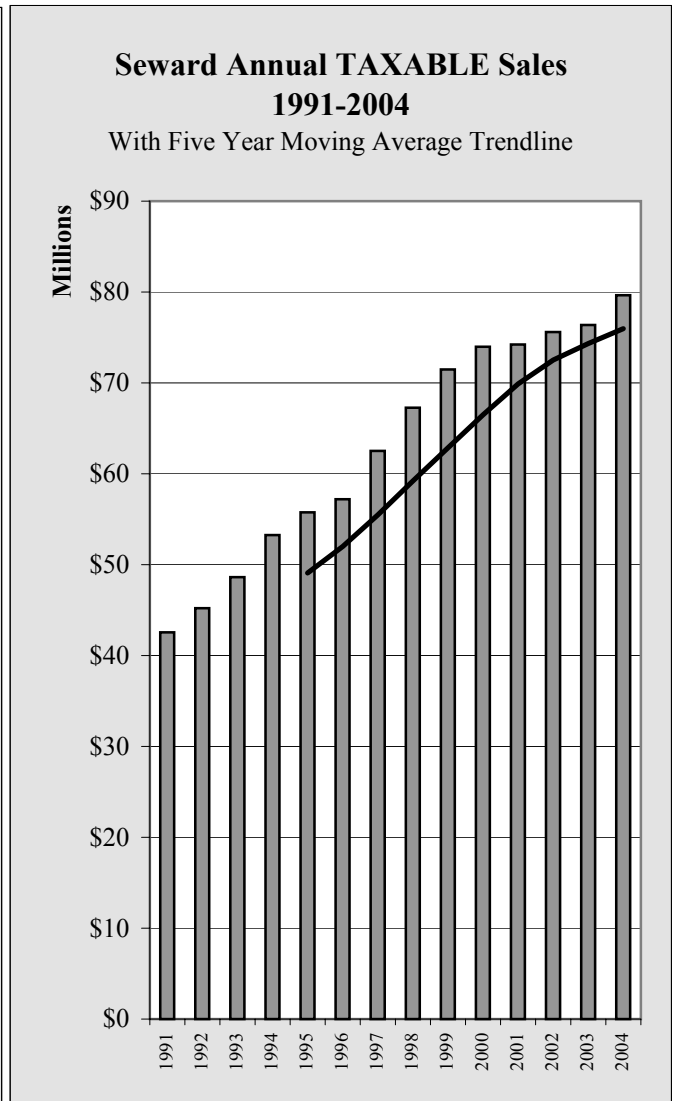

Chart 5.8

Seward Sales

Seward GROSS Sales by Industry by Quarter - 2001-2004 - in \$					
	1st Quarter	2nd Quarter	3rd Quarter	4th Quarter	Total
2001					
AFF	27,525	170,823	181,243	58,049	437,640
Min	63,891	105,401	129,526	32,041	330,859
Const	3,865,008	8,043,831	7,349,494	1,824,093	21,082,426
Manu	2,314,947	3,697,117	4,172,900	1,838,613	12,023,577
TCPU	2,321,975	3,524,903	4,717,487	2,276,587	12,840,952
Whole	361,455	671,328	816,708	382,240	2,231,731
Retail	6,972,958	15,137,856	20,218,997	8,078,507	50,408,318
FIRE	1,089,430	1,147,228	2,602,544	1,494,179	6,333,381
Service	3,514,083	11,953,791	22,684,750	4,519,045	42,671,669
Govt	0	0	0	0	0
Total	20,531,272	44,452,278	62,873,649	20,503,354	148,360,553
2002					
AFF	20,810	153,308	99,235	24,693	298,046
Min	48,952	131,150	133,354	63,985	377,441
Const	3,040,364	2,363,700	2,223,341	3,456,899	11,084,304
Manu	1,974,606	3,261,062	3,854,201	2,450,766	11,540,635
TCPU	2,253,103	3,404,989	5,193,908	2,174,323	13,026,323
Whole	386,897	671,893	755,749	394,120	2,208,659
Retail	7,932,221	15,310,055	21,049,806	8,308,672	52,600,754
FIRE	1,790,625	2,345,636	2,473,329	986,236	7,595,826
Service	5,506,435	12,743,583	20,938,726	4,446,394	43,635,138
Govt	0	0	0	0	0
Total	22,954,013	40,385,376	56,721,649	22,306,088	142,367,126
2003					
AFF	35,450	180,817	233,386	39,444	489,097
Min	67,921	49,589	49,094	23,151	189,755
Const	3,401,454	10,116,956	9,666,381	5,696,421	28,881,212
Manu	1,468,277	3,785,614	2,466,178	2,726,812	10,446,881
TCPU	2,084,901	3,313,681	5,201,510	2,369,763	12,969,855
Whole	385,079	682,756	888,555	644,189	2,600,579
Retail	7,796,709	14,977,089	21,297,449	9,521,774	53,593,021
FIRE	1,394,159	2,106,421	2,068,760	1,987,789	7,557,129
Service	4,299,310	11,771,230	19,836,458	4,325,071	40,232,069
Govt	0	0	0	0	0
Total	20,933,260	46,984,153	61,707,771	27,334,414	156,959,598
2004					
AFF	54,549	271,027	248,373	77,769	651,718
Min	24,996	78,789	89,202	35,416	228,403
Const	3,306,762	4,487,357	6,884,443	16,717,558	31,396,120
Manu	892,586	1,922,115	3,515,011	861,235	7,190,947
TCPU	2,592,442	3,233,313	3,387,400	2,304,768	11,517,923
Whole	544,648	910,240	1,199,749	1,298,948	3,953,585
Retail	8,616,690	17,930,784	24,109,491	9,245,748	59,902,713
FIRE	1,407,043	1,663,066	2,516,118	2,189,044	7,775,271
Service	4,622,534	12,656,829	21,621,536	5,830,750	44,731,649
Govt	0	0	0	0	0
Total	22,062,250	43,153,520	63,571,323	38,561,236	167,348,329

Table 5.5

Seward Sales

Seward TAXABLE Sales by Industry by Quarter - 2001-2004 - in \$					
	1st Quarter	2nd Quarter	3rd Quarter	4th Quarter	Total
2001					
AFF	3,990	69,770	81,902	14,962	170,624
Min	0	0	0	0	0
Const	130,066	160,218	146,352	130,990	567,626
Manu	124,810	312,269	402,392	122,911	962,382
TCPU	652,774	795,756	886,366	601,829	2,936,725
Whole	29,309	41,804	53,518	10,765	135,396
Retail	5,326,126	10,866,501	16,023,761	5,975,227	38,191,615
FIRE	363,832	433,701	481,279	386,891	1,665,703
Service	2,442,586	8,873,245	15,515,763	2,763,926	29,595,520
Govt	0	0	0	0	0
Total	9,073,493	21,553,264	33,591,333	10,007,501	74,225,591
2002					
AFF	6,729	57,747	39,602	10,443	114,521
Min	0	0	0	0	0
Const	128,807	140,758	155,433	140,292	565,290
Manu	115,801	299,221	451,494	122,143	988,659
TCPU	560,857	780,744	991,036	583,578	2,916,215
Whole	12,026	38,741	39,460	16,800	107,027
Retail	5,387,940	11,179,774	16,466,497	6,006,749	39,040,960
FIRE	354,630	488,696	593,326	343,944	1,780,596
Service	2,484,254	9,190,793	15,601,212	2,809,169	30,085,428
Govt	0	0	0	0	0
Total	9,051,044	22,176,474	34,338,060	10,033,118	75,598,696
2003					
AFF	11,673	70,505	116,949	18,196	217,323
Min	0	1,754	1,701	0	3,455
Const	126,874	190,057	174,588	192,071	683,590
Manu	144,853	157,138	183,847	143,810	629,648
TCPU	588,465	806,530	941,349	585,325	2,921,669
Whole	15,297	40,058	49,420	14,245	119,020
Retail	5,598,838	11,465,828	16,898,663	6,306,836	40,270,165
FIRE	330,069	415,752	530,822	316,440	1,593,083
Service	2,473,272	8,931,959	15,812,543	2,720,011	29,937,785
Govt	0	0	0	0	0
Total	9,289,341	22,079,581	34,709,882	10,296,934	76,375,738
2004					
AFF	11,923	77,870	129,744	7,800	227,337
Min	0	0	0	0	0
Const	167,430	198,782	187,781	184,187	738,180
Manu	131,626	162,634	163,756	132,142	590,158
TCPU	581,778	758,614	826,027	502,067	2,668,486
Whole	23,473	34,969	34,753	14,723	107,918
Retail	5,826,218	11,944,392	18,160,048	6,399,411	42,330,069
FIRE	297,198	396,148	564,636	328,059	1,586,041
Service	2,455,335	9,413,007	16,817,312	2,706,081	31,391,735
Govt	0	0	0	0	0
Total	9,494,981	22,986,416	36,884,057	10,274,470	79,639,924

Table 5.6

Seward Construction Permitting

Seward 4th Quarter Permit Values by Type - 1998-2004 - in \$								
	1998	1999	2000	2001	2002	2003	2004	Annual Change
Residential New	0	123,000	0	300,000	0	0	0	NA
Residential Alter/Add	34,500	15,000	339,400	105,000	19,800	50,000	8,000	-84.0%
Commercial New	260,000	240,000	200,000	0	2,100,000	5,000	0	-100.0%
Commercial Alter/Add	5,100	125,000	80,000	587,000	113,000	517,500	251,350	-51.4%
Total	299,600	503,000	619,400	992,000	2,232,800	572,500	259,350	-54.7%
Annual Change		67.9%	23.1%	60.2%	125.1%	-74.4%	-54.7%	

Table 5.7

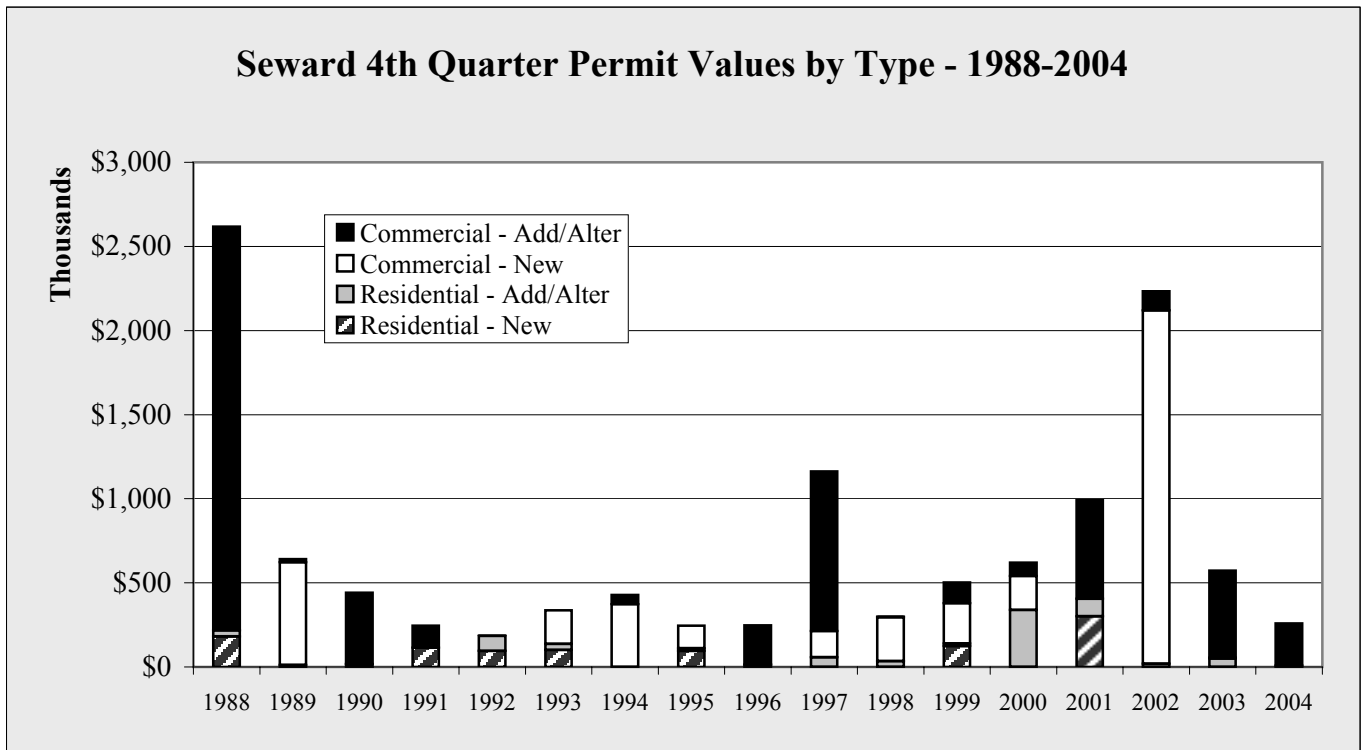

Chart 5.9



Chart 5.10

Seward Construction Permitting

Seward 4th Quarter Permit Volume by Type - 1998-2004

	1998	1999	2000	2001	2002	2003	2004	Annual Change
Residential New	0	1	0	2	0	0	0	NA
Residential Alter/Add	5	2	4	2	4	1	1	0.0%
Commercial New	1	1	1	0	3	1	0	-100.0%
Commercial Alter/Add	1	6	4	5	4	9	6	-33.3%
Total	7	10	9	9	11	11	7	-36.4%
Annual Change		42.9%	-10.0%	0.0%	22.2%	0.0%	-36.4%	

Table 5.8

Seward 4th Quarter Permit Volume by Type - 1988-2004

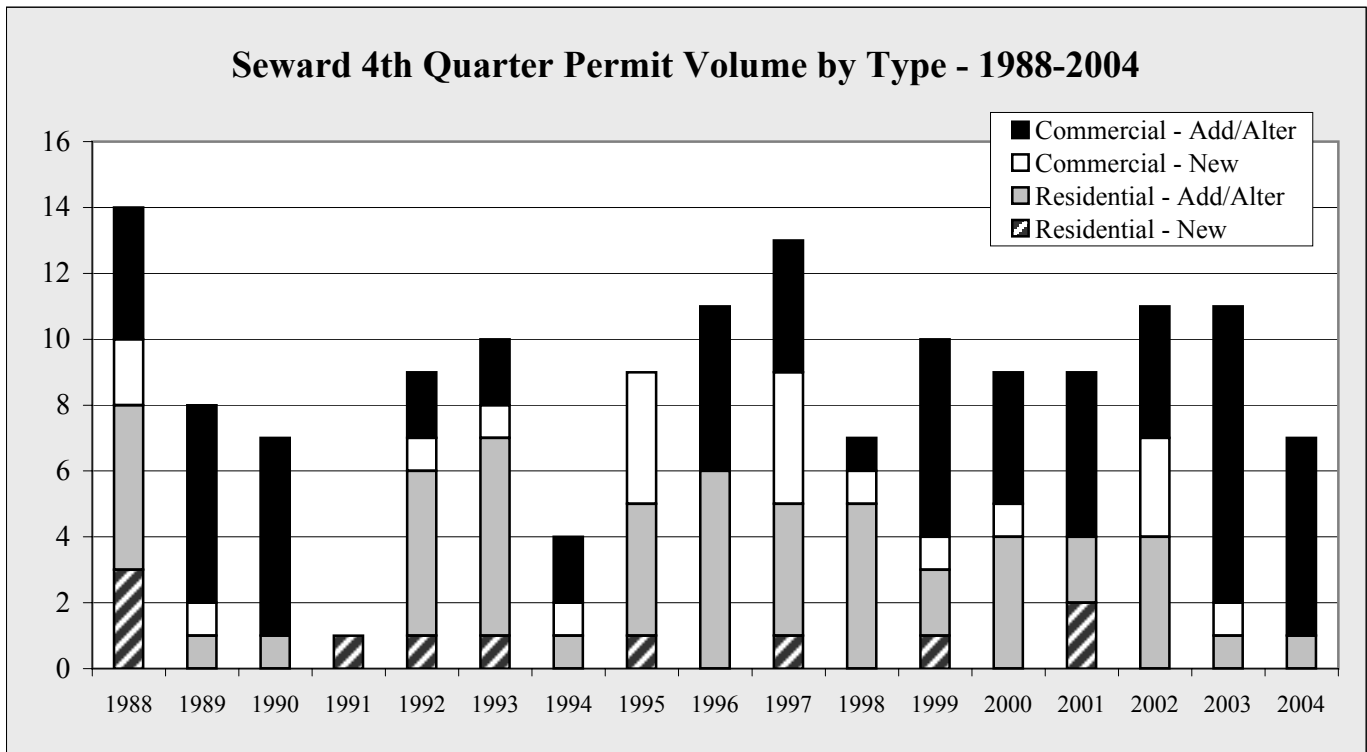

Chart 5.11

Seward 4th Quarter Permit Volume Percent by Type - 2004

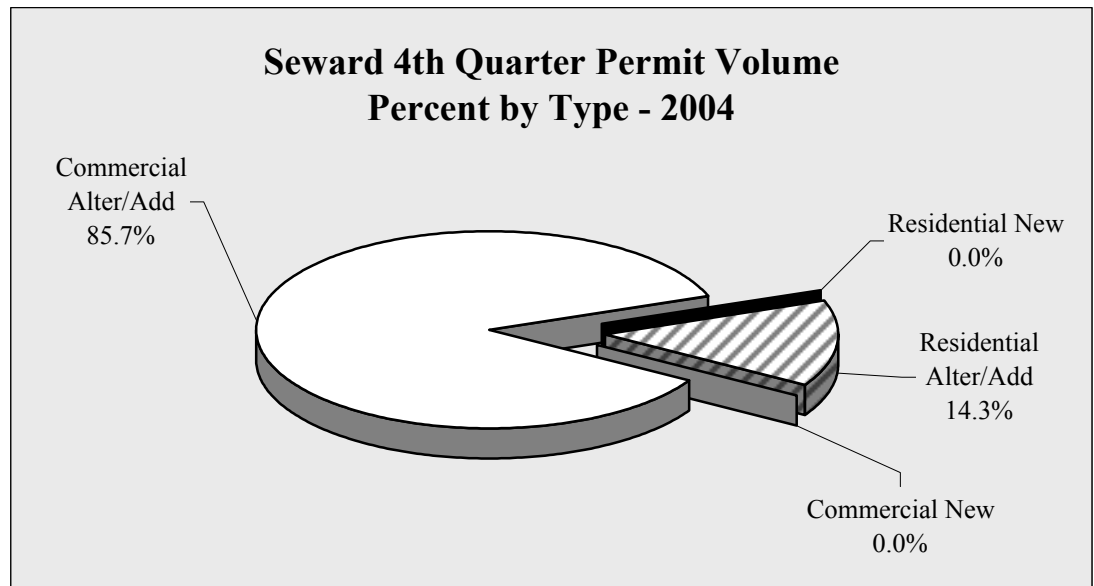

Chart 5.12

Seward Construction Permitting

Seward Annual Permit Values by Type - 1998-2004 - in \$

	1998	1999	2000	2001	2002	2003	2004	Annual Change
Residential New	1,145,000	1,217,400	1,023,000	450,000	725,000	1,077,500	2,130,000	97.7%
Residential Alter/Add	240,543	256,600	446,000	344,214	242,008	294,500	500,400	69.9%
Commercial New	4,925,232	1,393,275	825,000	486,028	6,144,730	4,290,000	13,018,800	203.5%
Commercial Alter/Add	437,086	1,374,138	1,157,565	1,436,739	798,965	2,320,765	2,061,950	-11.2%
Total	6,747,861	4,241,413	3,451,565	2,716,981	7,910,703	7,982,765	17,711,150	121.9%
Annual Change		-37.1%	-18.6%	-21.3%	191.2%	0.9%	121.9%	

Table 5.9

Seward Annual Permit Values by Type - 1988-2004

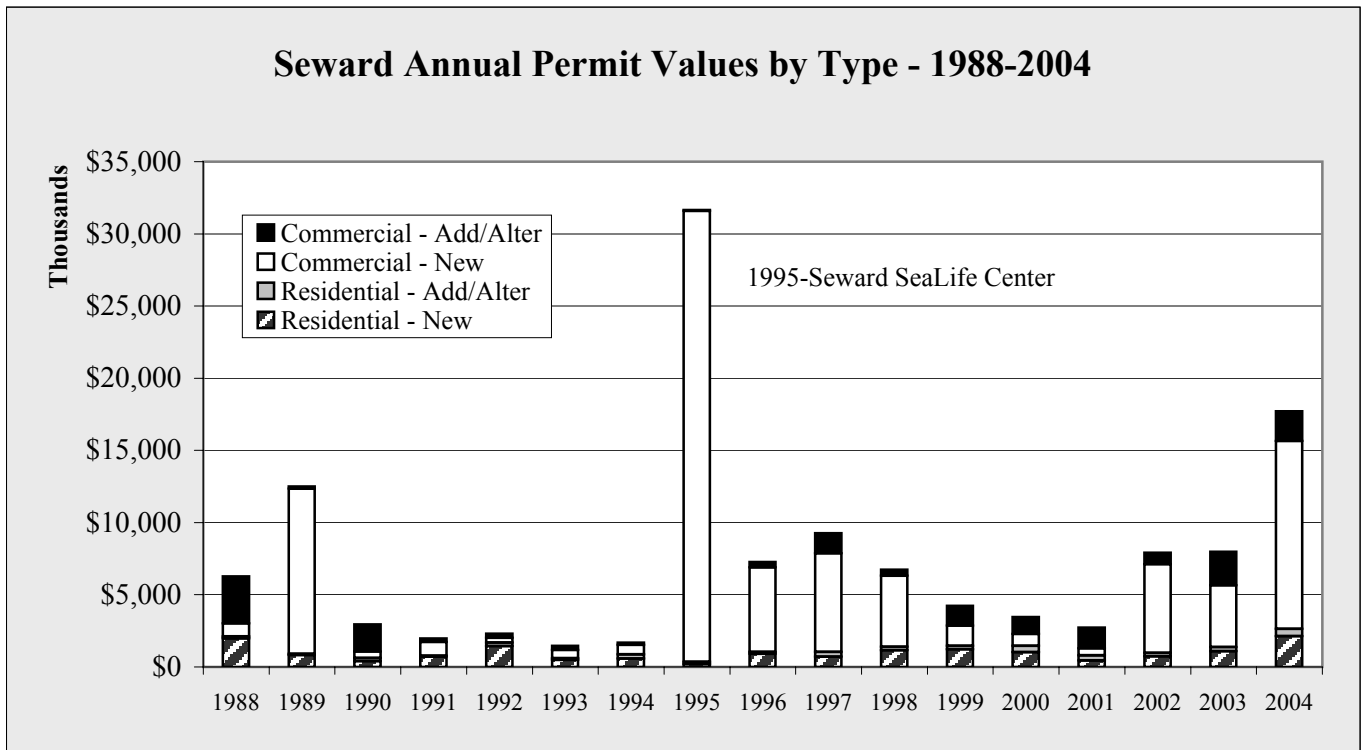

Chart 5.13

Seward Annual Permit Values Percent by Type - 2004

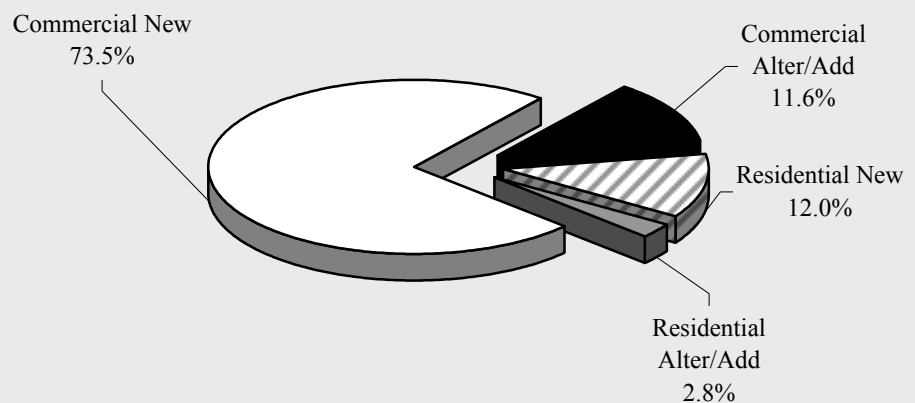

Chart 5.14

Seward Construction Permitting

Seward Annual Permit Volume by Type - 1998-2004								
	1998	1999	2000	2001	2002	2003	2004	Annual Change
Residential New	9	10	5	3	4	8	12	50.0%
Residential Alter/Add	18	15	19	18	25	11	15	36.4%
Commercial New	10	7	8	6	8	7	4	-42.9%
Commercial Alter/Add	12	24	19	21	27	24	23	-4.2%
Total	49	56	51	48	64	50	54	8.0%
Annual Change		14.3%	-8.9%	-5.9%	33.3%	-21.9%	8.0%	

Table 5.10

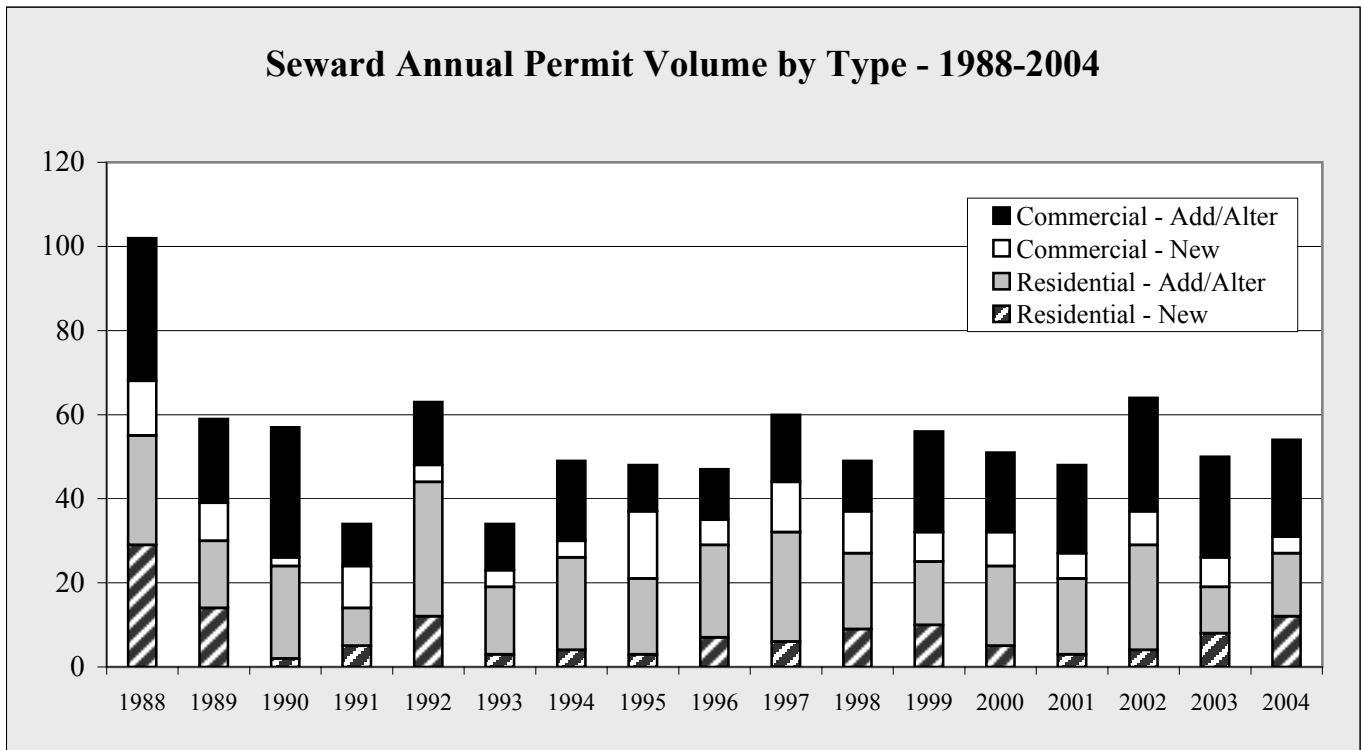

Chart 5.15

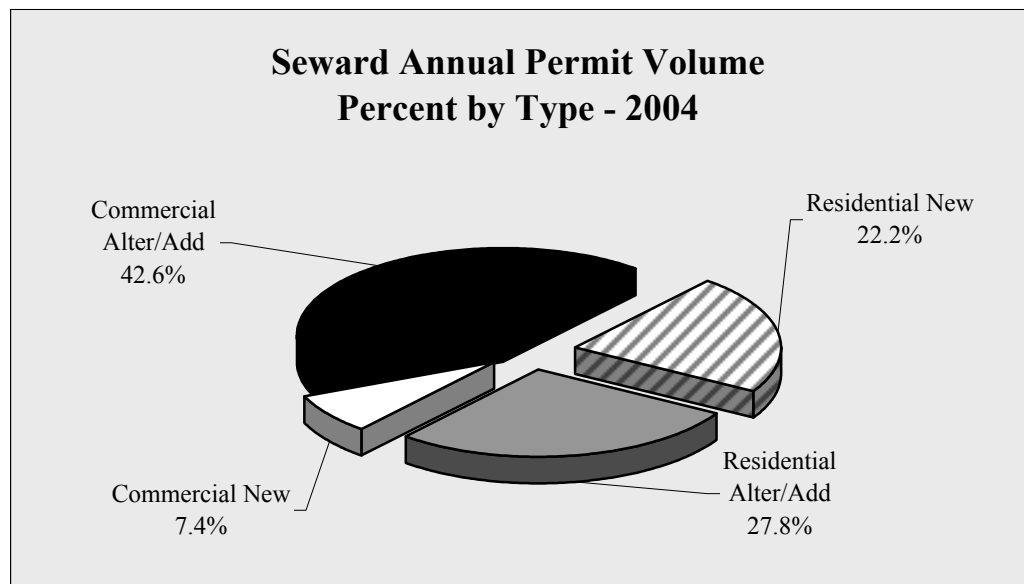

Chart 5.16

Seward Construction Permitting

Seward Annual Permit Values by Type by Quarter - 1997-2004 - in \$					
	1st Quarter	2nd Quarter	3rd Quarter	4th Quarter	Total
1997					
Residential - New	0	628,750	78,000	0	706,750
Residential - Add/Alter	0	164,492	110,500	57,300	332,292
Commercial - New	4,675,000	1,609,800	388,000	156,000	6,828,800
Commercial - Add/Alter	87,300	91,186	266,400	948,419	1,393,305
TOTAL	4,762,300	2,494,228	842,900	1,161,719	9,261,147
1998					
Residential - New	85,000	643,000	417,000	0	1,145,000
Residential - Add/Alter	25,043	122,000	59,000	34,500	240,543
Commercial - New	536,232	75,000	4,054,000	260,000	4,925,232
Commercial - Add/Alter	56,800	119,000	256,186	5,100	437,086
TOTAL	703,075	959,000	4,786,186	299,600	6,747,861
1999					
Residential - New	0	585,000	509,400	123,000	1,217,400
Residential - Add/Alter	5,200	164,500	71,900	15,000	256,600
Commercial - New	0	250,000	903,275	240,000	1,393,275
Commercial - Add/Alter	1,035,350	82,614	131,174	125,000	1,374,138
TOTAL	1,040,550	1,082,114	1,615,749	503,000	4,241,413
2000					
Residential - New	230,000	530,000	263,000	0	1,023,000
Residential - Add/Alter	0	67,600	39,000	339,400	446,000
Commercial - New	85,000	210,000	330,000	200,000	825,000
Commercial - Add/Alter	40,300	957,800	79,465	80,000	1,157,565
TOTAL	355,300	1,765,400	711,465	619,400	3,451,565
2001					
Residential - New	0	0	150,000	300,000	450,000
Residential - Add/Alter	30,200	73,000	136,014	105,000	344,214
Commercial - New	0	155,000	331,028	0	486,028
Commercial - Add/Alter	386,500	438,239	25,000	587,000	1,436,739
TOTAL	416,700	666,239	642,042	992,000	2,716,981
2002					
Residential - New	120,000	400,000	205,000	0	725,000
Residential - Add/Alter	25,496	169,157	27,555	19,800	242,008
Commercial - New	0	3,294,730	750,000	2,100,000	6,144,730
Commercial - Add/Alter	335,944	25,000	325,021	113,000	798,965
TOTAL	481,440	3,888,887	1,307,576	2,232,800	7,910,703
2003					
Residential - New	118,000	215,000	744,500	0	1,077,500
Residential - Add/Alter	57,500	100,000	87,000	50,000	294,500
Commercial - New	72,000	3,313,000	900,000	5,000	4,290,000
Commercial - Add/Alter	1,657,855	44,010	101,400	517,500	2,320,765
TOTAL	1,905,355	3,672,010	1,832,900	572,500	7,982,765
2004					
Residential - New	0	873,000	1,257,000	0	2,130,000
Residential - Add/Alter	48,000	144,900	299,500	8,000	500,400
Commercial - New	7,500,000	5,000,000	518,800	0	13,018,800
Commercial - Add/Alter	193,600	1,426,000	191,000	251,350	2,061,950
TOTAL	7,741,600	7,443,900	2,266,300	259,350	17,711,150

Table 5.11

Seward Construction Permitting

Seward Annual Permit Volume by Type by Quarter - 1997-2004					
	1st Quarter	2nd Quarter	3rd Quarter	4th Quarter	Total
1997					
Residential - New	0	4	1	1	6
Residential - Add/Alter	0	13	9	4	26
Commercial - New	2	3	3	4	12
Commercial - Add/Alter	6	3	3	4	16
TOTAL	8	23	16	13	60
1998					
Residential - New	1	6	2	0	9
Residential - Add/Alter	4	4	5	5	18
Commercial - New	2	3	4	1	10
Commercial - Add/Alter	2	7	2	1	12
TOTAL	9	20	13	7	49
1999					
Residential - New	0	5	4	1	10
Residential - Add/Alter	1	7	5	2	15
Commercial - New	0	1	5	1	7
Commercial - Add/Alter	4	5	9	6	24
TOTAL	5	18	23	10	56
2000					
Residential - New	1	2	2	0	5
Residential - Add/Alter	0	8	7	4	19
Commercial - New	1	3	3	1	8
Commercial - Add/Alter	3	7	5	4	19
TOTAL	5	20	17	9	51
2001					
Residential - New	0	0	1	2	3
Residential - Add/Alter	4	3	9	2	18
Commercial - New	0	3	3	0	6
Commercial - Add/Alter	7	8	1	5	21
TOTAL	11	14	14	9	48
2002					
Residential - New	1	1	2	0	4
Residential - Add/Alter	3	15	3	4	25
Commercial - New	0	4	1	3	8
Commercial - Add/Alter	6	9	8	4	27
TOTAL	10	29	14	11	64
2003					
Residential - New	1	2	5	0	8
Residential - Add/Alter	2	3	5	1	11
Commercial - New	1	4	1	1	7
Commercial - Add/Alter	7	4	4	9	24
TOTAL	11	13	15	11	50
2004					
Residential - New	0	4	8	0	12
Residential - Add/Alter	2	7	5	1	15
Commercial - New	1	1	2	0	4
Commercial - Add/Alter	4	9	4	6	23
TOTAL	7	21	19	7	54

Table 5.12

Soldotna Sales

Soldotna 4th Quarter GROSS Sales by Industry - 1998-2004 - in \$								
	1998	1999	2000	2001	2002	2003	2004	Annual Change
AFF	122,431	217,744	262,358	269,662	461,273	757,548	975,098	28.7%
Min	1,135,353	81,064	100,575	53,304	119,470	118,724	165,250	39.2%
Const	6,231,433	6,309,023	6,093,210	4,897,000	5,990,804	6,126,857	9,593,692	56.6%
Manu	726,600	651,359	1,433,479	1,261,012	1,321,057	1,468,244	806,641	-45.1%
TCPU	3,724,804	4,480,636	3,990,606	3,904,674	3,782,935	4,587,100	5,014,865	9.3%
Whole	5,161,109	7,569,235	4,719,082	6,765,030	12,251,677	6,942,427	6,752,679	-2.7%
Retail	40,355,055	41,728,045	45,263,100	49,356,300	45,511,862	49,751,591	52,266,759	5.1%
FIRE	1,646,315	2,068,526	2,355,055	2,910,221	2,632,224	2,902,737	3,048,089	5.0%
Service	7,490,625	7,470,400	7,788,219	8,184,608	8,105,750	9,491,364	14,059,758	48.1%
Govt	2,426	3,577	2,215	1,200	3,730	8,526	2,674	-68.6%
Total	66,596,151	70,579,609	72,007,899	77,603,011	80,180,782	82,155,118	92,685,505	12.8%
Annual Change		6.0%	2.0%	7.8%	3.3%	2.5%	12.8%	

Table 6.1

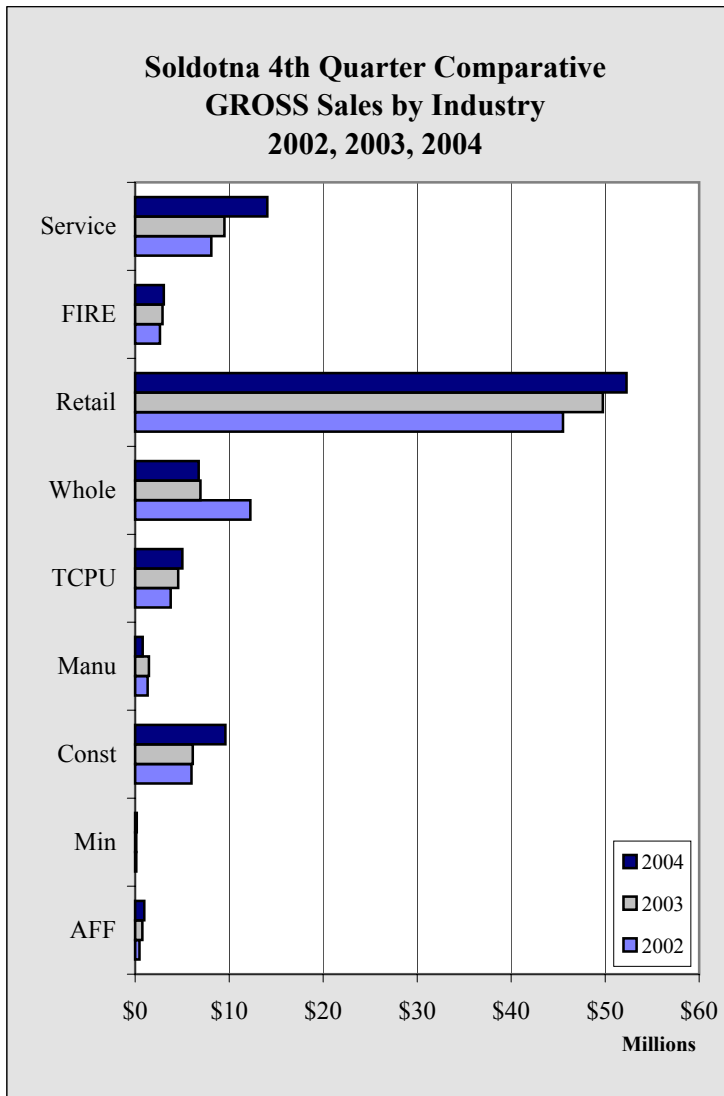

Chart 6.1

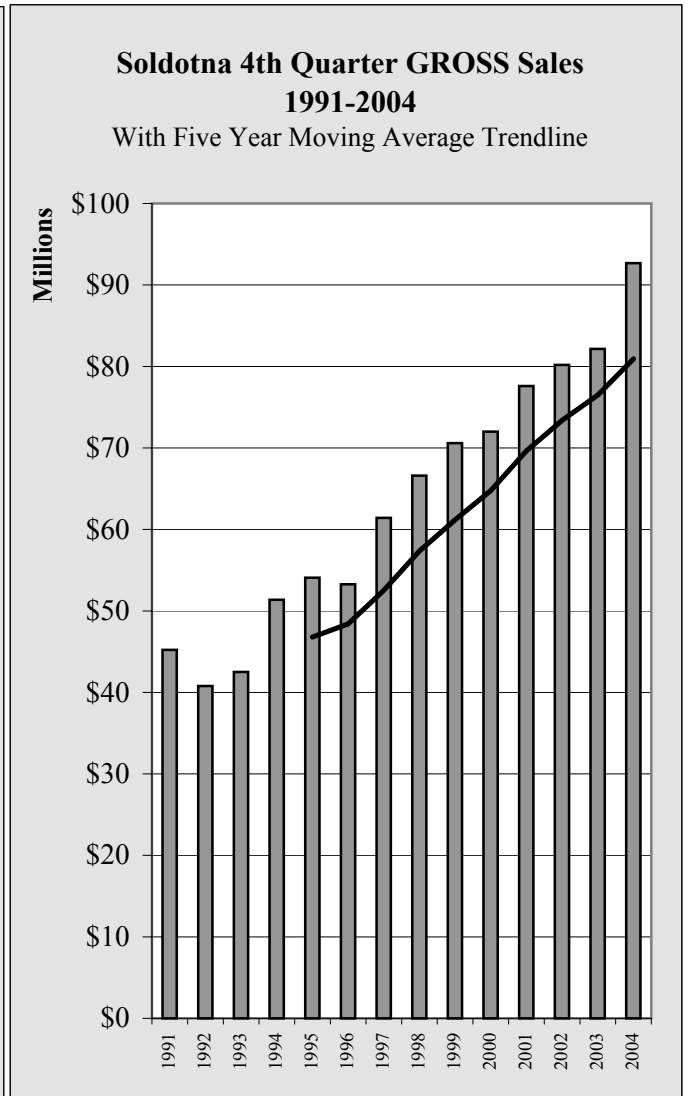

Chart 6.2

Soldotna Sales

Soldotna 4th Quarter TAXABLE Sales by Industry - 1998-2004 - in \$								
	1998	1999	2000	2001	2002	2003	2004	Annual Change
AFF	114,886	183,590	199,729	206,673	178,474	253,747	186,296	-26.6%
Min	1,500	1,460	1,238	8,264	11,581	8,407	4,793	-43.0%
Const	339,593	363,792	297,506	283,797	335,538	393,003	380,580	-3.2%
Manu	259,176	266,663	243,232	296,404	314,430	278,591	314,965	13.1%
TCPU	2,414,900	2,791,437	2,518,338	2,696,919	2,861,745	3,152,320	3,146,788	-0.2%
Whole	62,801	82,528	141,739	128,503	145,509	196,331	133,454	-32.0%
Retail	29,417,311	31,010,280	32,397,826	34,350,723	33,338,606	37,680,413	37,982,870	0.8%
FIRE	906,894	879,930	1,243,047	1,361,487	1,339,492	982,621	1,003,076	2.1%
Service	3,314,622	3,223,778	3,437,039	3,534,769	3,719,598	3,604,381	3,568,874	-1.0%
Govt	2,426	3,577	2,215	1,200	3,730	8,526	2,674	-68.6%
Total	36,834,109	38,807,035	40,481,909	42,868,739	42,248,703	46,558,340	46,724,370	0.4%
Annual Change		5.4%	4.3%	5.9%	-1.4%	10.2%	0.4%	

Table 6.2

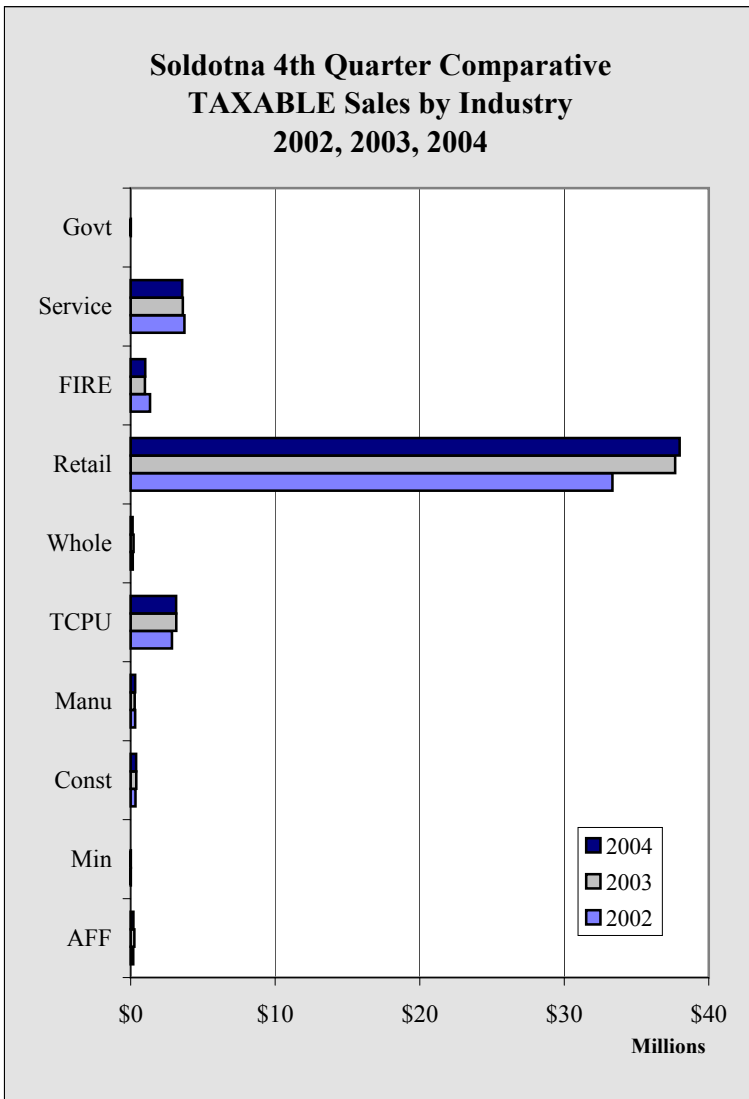

Chart 6.3

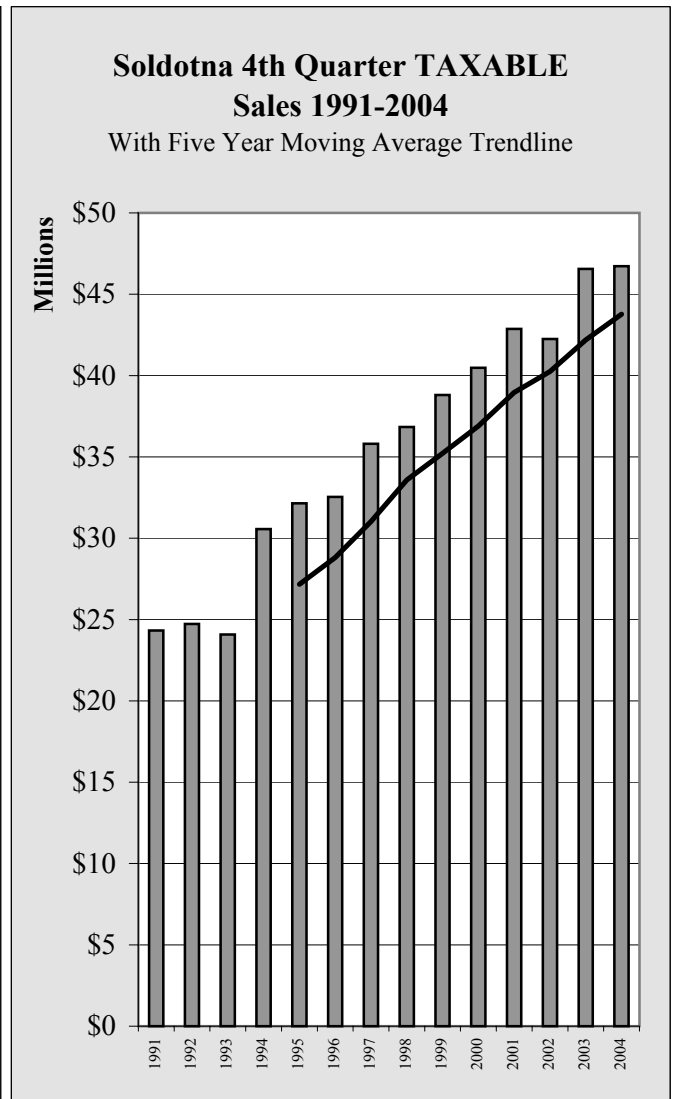

Chart 6.4

Soldotna Sales

Soldotna Annual GROSS Sales by Industry - 1998-2004 - in \$								
	1998	1999	2000	2001	2002	2003	2004	Annual Change
AFF	689,389	954,143	1,727,448	1,664,917	1,853,591	2,523,473	3,220,701	27.6%
Min	2,729,541	306,689	305,525	305,091	410,684	450,504	548,472	21.7%
Const	20,205,240	17,075,443	20,761,485	19,395,458	22,467,091	20,813,302	27,675,084	33.0%
Manu	3,192,979	3,210,218	5,446,988	5,938,040	6,301,658	7,729,281	4,340,723	-43.8%
TCPU	14,308,591	17,467,668	15,708,998	17,799,215	15,900,605	16,342,600	20,220,101	23.7%
Whole	14,626,150	32,515,047	32,610,279	31,467,653	40,201,769	34,368,869	28,767,290	-16.3%
Retail	157,774,054	166,898,488	170,201,586	187,606,859	191,944,180	204,741,275	216,019,818	5.5%
FIRE	7,365,455	8,509,983	10,210,170	10,232,574	10,465,959	10,733,557	11,861,966	10.5%
Service	29,884,044	30,622,659	32,265,770	34,689,321	36,330,903	40,028,395	48,149,446	20.3%
Govt	18,221	28,399	17,062	19,103	22,579	41,717	20,979	-49.7%
Total	250,793,664	277,588,737	289,255,311	309,118,231	325,899,019	337,772,973	360,824,580	6.8%
Annual Change		10.7%	4.2%	6.9%	5.4%	3.6%	6.8%	

Table 6.3

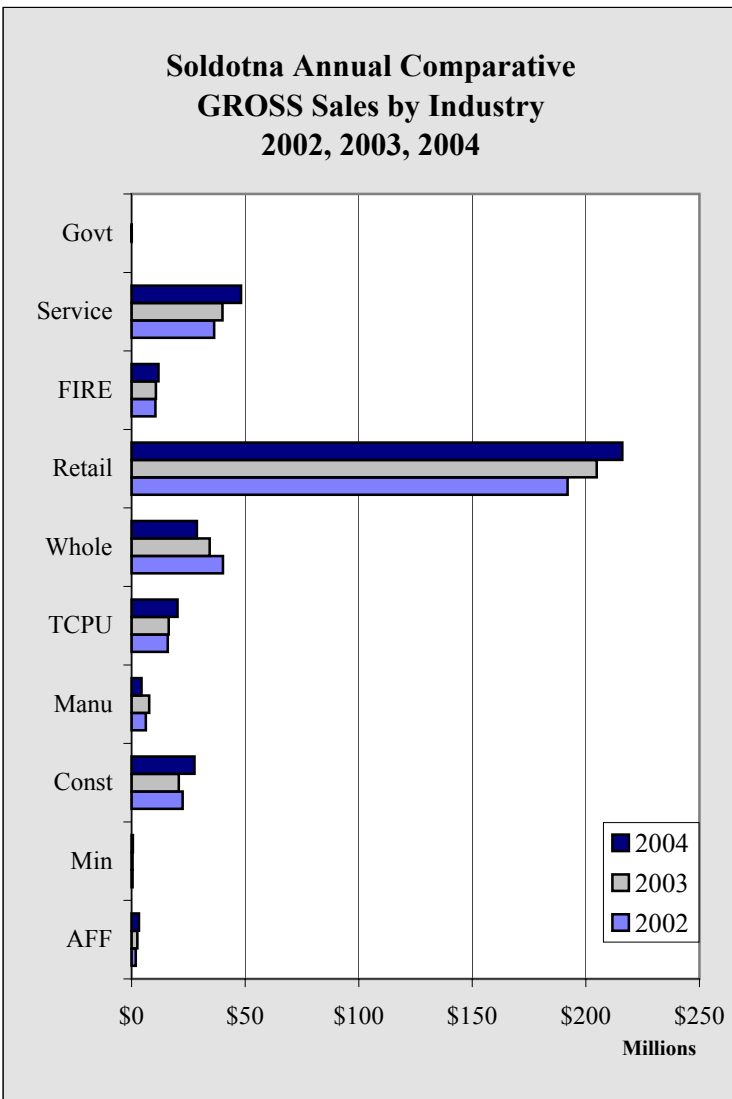

Chart 6.5

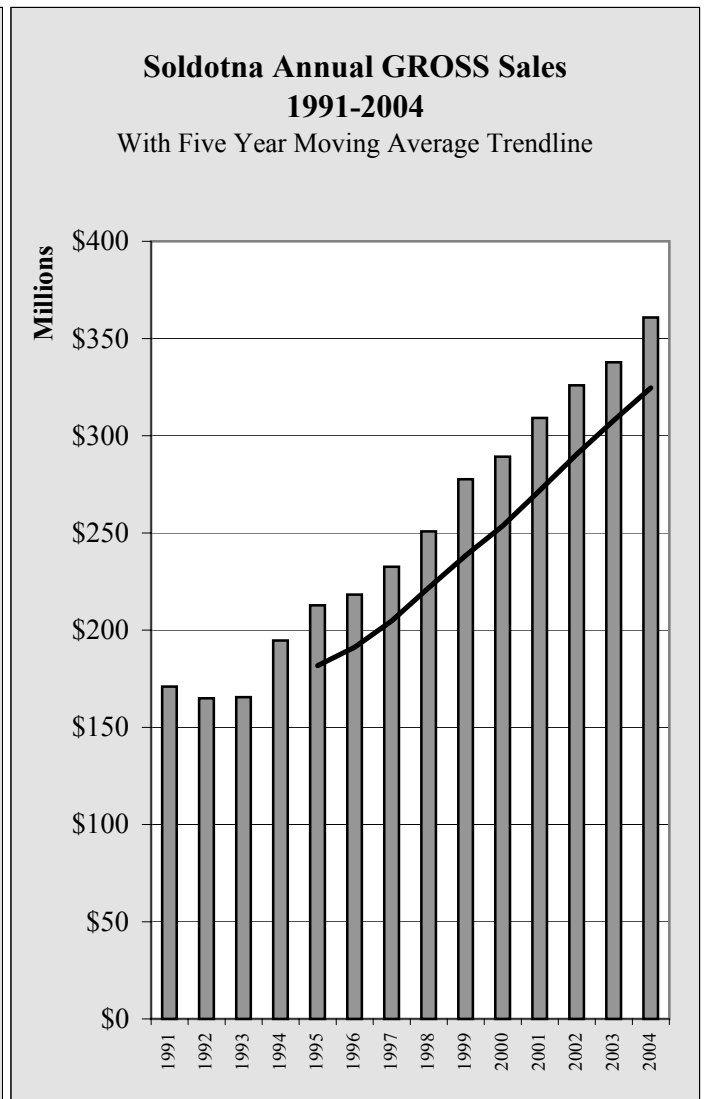

Chart 6.6

Soldotna Sales

Soldotna Annual TAXABLE Sales by Industry - 1998-2004 - in \$								
	1998	1999	2000	2001	2002	2003	2004	Annual Change
AFF	466,912	697,062	921,908	1,117,793	1,043,812	1,176,634	1,120,573	-4.8%
Min	8,010	5,675	11,333	35,080	33,278	33,067	20,326	-38.5%
Const	1,320,297	1,471,239	1,233,755	1,173,265	1,317,838	1,590,497	1,443,242	-9.3%
Manu	1,439,440	1,467,864	1,567,147	1,638,254	1,635,572	1,674,325	1,692,628	1.1%
TCPU	9,374,360	10,378,566	10,311,502	10,527,433	11,178,060	12,295,182	12,419,692	1.0%
Whole	369,062	322,925	715,161	786,443	763,236	997,320	805,376	-19.2%
Retail	115,732,671	122,401,180	124,618,575	136,194,643	138,178,507	151,168,576	159,047,903	5.2%
FIRE	3,662,452	3,776,435	4,545,775	5,207,613	5,279,203	4,435,121	4,380,319	-1.2%
Service	15,398,236	15,403,419	15,493,910	15,718,811	17,525,783	17,204,443	18,184,630	5.7%
Govt	18,221	28,399	17,062	19,103	22,579	41,717	20,979	-49.7%
Total	147,789,661	155,952,764	159,436,128	172,418,438	176,977,868	190,616,882	199,135,668	4.5%
Annual Change		5.5%	2.2%	8.1%	2.6%	7.7%	4.5%	

Table 6.4

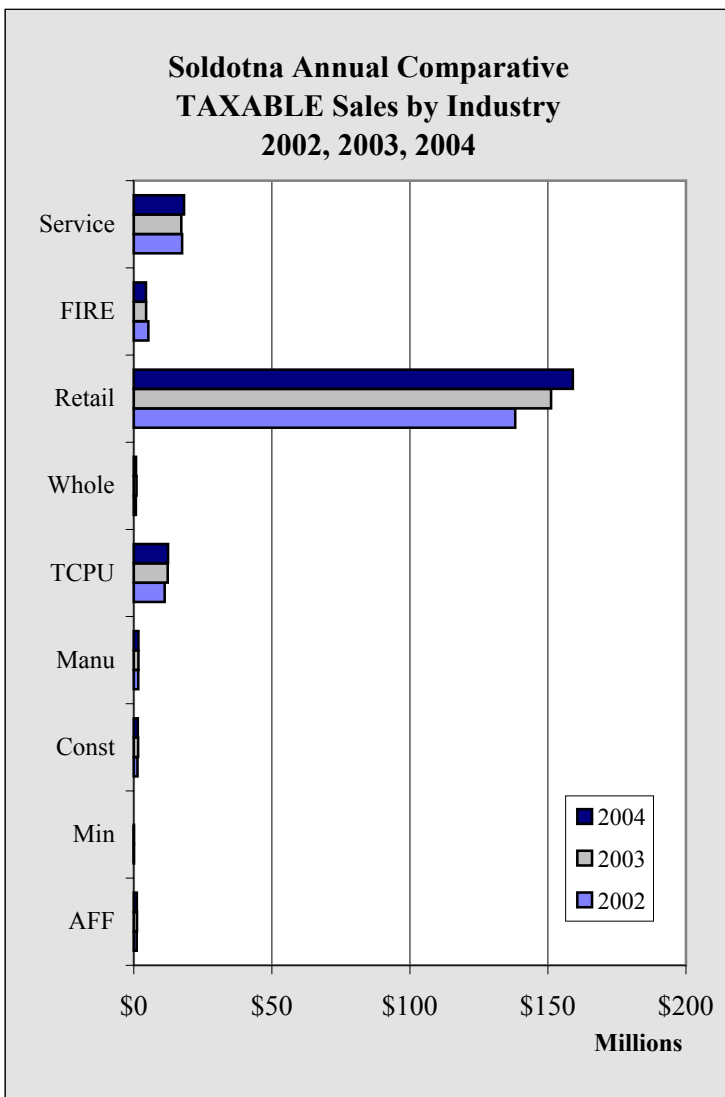

Chart 6.7

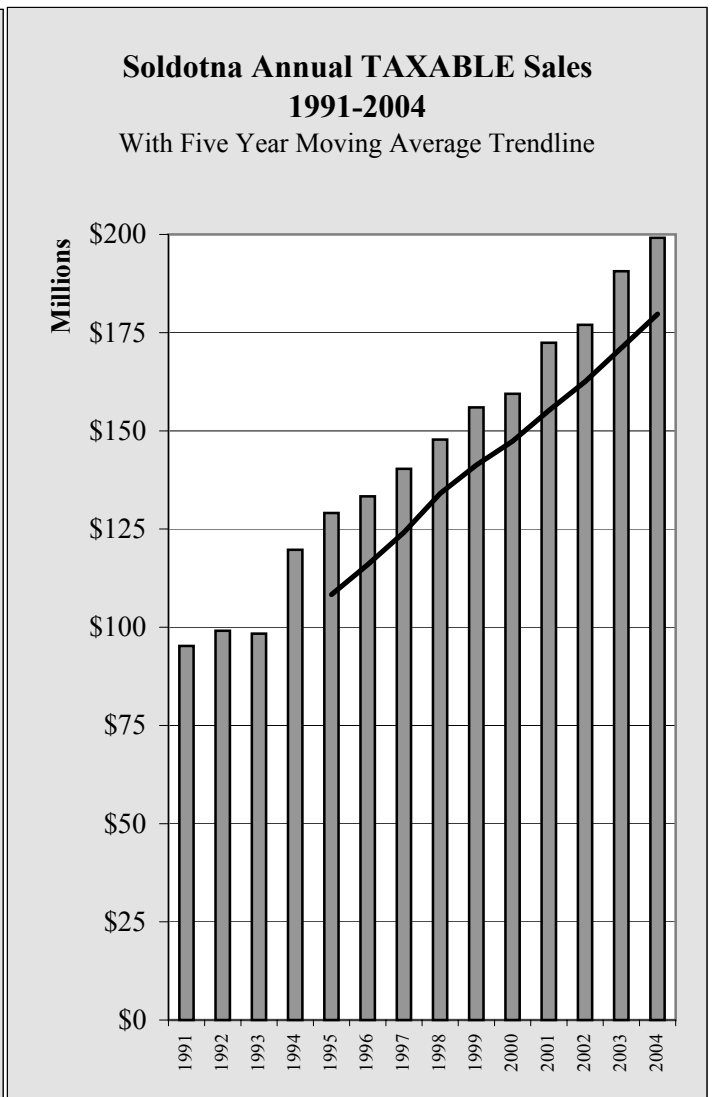

Chart 6.8

Soldotna Sales

Soldotna GROSS Sales by Industry by Quarter - 2000-2004 - in \$					
	1st Quarter	2nd Quarter	3rd Quarter	4th Quarter	Total
2000					
AFF	158,182	379,092	927,816	262,358	1,727,448
Min	71,262	80,235	53,453	100,575	305,525
Const	3,044,411	4,925,887	6,697,977	6,093,210	20,761,485
Manu	641,545	1,149,365	2,222,599	1,433,479	5,446,988
TCPU	4,039,609	3,684,195	3,994,588	3,990,606	15,708,998
Whole	7,278,779	8,721,917	11,890,501	4,719,082	32,610,279
Retail	31,528,136	42,547,382	50,862,968	45,263,100	170,201,586
FIRE	1,976,395	2,743,036	3,135,684	2,355,055	10,210,170
Service	6,456,290	8,278,327	9,742,934	7,788,219	32,265,770
Govt	7,287	5,779	1,781	2,215	17,062
Total	55,201,896	72,515,215	89,530,301	72,007,899	289,255,311
2001					
AFF	215,220	486,756	693,279	269,662	1,664,917
Min	49,472	77,886	124,429	53,304	305,091
Const	4,015,371	4,464,446	6,018,641	4,897,000	19,395,458
Manu	967,938	1,611,027	2,098,063	1,261,012	5,938,040
TCPU	4,764,455	4,573,146	4,556,940	3,904,674	17,799,215
Whole	6,827,062	6,981,240	10,894,321	6,765,030	31,467,653
Retail	34,715,249	45,690,237	57,845,073	49,356,300	187,606,859
FIRE	2,166,881	2,223,114	2,932,358	2,910,221	10,232,574
Service	7,074,122	8,929,421	10,501,170	8,184,608	34,689,321
Govt	6,507	5,238	6,158	1,200	19,103
Total	60,802,277	75,042,511	95,670,432	77,603,011	309,118,231
2002					
AFF	231,354	493,143	667,821	461,273	1,853,591
Min	98,101	106,949	86,164	119,470	410,684
Const	3,228,042	4,934,965	8,313,280	5,990,804	22,467,091
Manu	900,894	1,727,614	2,352,093	1,321,057	6,301,658
TCPU	3,685,725	3,531,451	4,900,494	3,782,935	15,900,605
Whole	8,072,050	7,353,520	12,524,522	12,251,677	40,201,769
Retail	36,487,247	49,060,629	60,884,442	45,511,862	191,944,180
FIRE	2,258,203	2,983,720	2,591,812	2,632,224	10,465,959
Service	7,363,434	9,561,798	11,299,921	8,105,750	36,330,903
Govt	6,700	7,859	4,290	3,730	22,579
Total	62,331,750	79,761,648	103,624,839	80,180,782	325,899,019
2003					
AFF	287,421	558,058	920,446	757,548	2,523,473
Min	110,629	122,012	99,139	118,724	450,504
Const	3,997,918	3,954,148	6,734,379	6,126,857	20,813,302
Manu	1,129,391	2,288,148	2,843,498	1,468,244	7,729,281
TCPU	4,211,327	3,827,252	3,716,921	4,587,100	16,342,600
Whole	7,309,289	9,554,591	10,562,562	6,942,427	34,368,869
Retail	36,787,701	52,189,612	66,012,371	49,751,591	204,741,275
FIRE	2,461,298	2,547,857	2,821,665	2,902,737	10,733,557
Service	7,926,425	10,128,839	12,481,767	9,491,364	40,028,395
Govt	12,319	8,680	12,192	8,526	41,717
Total	64,233,718	85,179,197	106,204,940	82,155,118	337,772,973
2004					
AFF	556,985	645,572	1,043,046	975,098	3,220,701
Min	92,181	154,892	136,149	165,250	548,472
Const	2,956,843	5,879,390	9,245,159	9,593,692	27,675,084
Manu	543,783	1,132,457	1,857,842	806,641	4,340,723
TCPU	4,796,956	4,716,238	5,692,042	5,014,865	20,220,101
Whole	9,720,151	8,967,548	3,326,912	6,752,679	28,767,290
Retail	39,606,915	54,023,404	70,122,740	52,266,759	216,019,818
FIRE	3,032,921	2,959,391	2,821,565	3,048,089	11,861,966
Service	9,492,190	11,834,460	12,763,038	14,059,758	48,149,446
Govt	6,904	8,521	2,880	2,674	20,979
Total	70,805,829	90,321,873	107,011,373	92,685,505	360,824,580

Table 6.5

Soldotna Sales

Soldotna TAXABLE Sales by Industry by Quarter - 2000-2004 - in \$					
	1st Quarter	2nd Quarter	3rd Quarter	4th Quarter	Total
2000					
AFF	148,104	227,222	346,853	199,729	921,908
Min	1,148	6,707	2,240	1,238	11,333
Const	316,000	290,180	330,069	297,506	1,233,755
Manu	194,558	412,829	716,528	243,232	1,567,147
TCPU	2,608,749	2,571,379	2,613,036	2,518,338	10,311,502
Whole	71,213	229,376	272,833	141,739	715,161
Retail	22,423,668	29,942,234	39,854,847	32,397,826	124,618,575
FIRE	860,411	1,066,696	1,375,621	1,243,047	4,545,775
Service	3,033,282	4,014,214	5,009,375	3,437,039	15,493,910
Govt	7,287	5,779	1,781	2,215	17,062
Total	29,664,420	38,766,616	50,523,183	40,481,909	159,436,128
2001					
AFF	183,856	314,053	413,211	206,673	1,117,793
Min	7,612	10,242	8,962	8,264	35,080
Const	234,518	301,807	353,143	283,797	1,173,265
Manu	199,966	465,257	676,627	296,404	1,638,254
TCPU	2,584,193	2,584,818	2,661,503	2,696,919	10,527,433
Whole	124,637	282,881	250,422	128,503	786,443
Retail	25,030,145	33,538,956	43,274,819	34,350,723	136,194,643
FIRE	1,072,034	1,222,567	1,551,525	1,361,487	5,207,613
Service	3,048,909	4,188,255	4,946,878	3,534,769	15,718,811
Govt	6,507	5,238	6,158	1,200	19,103
Total	32,492,377	42,914,074	54,143,248	42,868,739	172,418,438
2002					
AFF	185,252	286,565	393,521	178,474	1,043,812
Min	6,447	7,414	7,836	11,581	33,278
Const	283,099	329,803	369,398	335,538	1,317,838
Manu	181,486	429,327	710,329	314,430	1,635,572
TCPU	2,752,273	2,619,156	2,944,886	2,861,745	11,178,060
Whole	135,437	231,064	251,226	145,509	763,236
Retail	25,570,526	33,723,015	45,546,360	33,338,606	138,178,507
FIRE	1,170,633	1,266,667	1,502,411	1,339,492	5,279,203
Service	3,444,755	4,603,064	5,758,366	3,719,598	17,525,783
Govt	6,700	7,859	4,290	3,730	22,579
Total	33,736,608	43,503,934	57,488,623	42,248,703	176,977,868
2003					
AFF	167,593	297,426	457,868	253,747	1,176,634
Min	9,374	7,401	7,885	8,407	33,067
Const	301,760	430,437	465,297	393,003	1,590,497
Manu	219,705	436,364	739,665	278,591	1,674,325
TCPU	3,219,035	2,964,183	2,959,644	3,152,320	12,295,182
Whole	173,053	288,627	339,309	196,331	997,320
Retail	25,769,374	36,976,302	50,742,487	37,680,413	151,168,576
FIRE	1,141,419	1,151,616	1,159,465	982,621	4,435,121
Service	3,449,990	4,457,613	5,692,459	3,604,381	17,204,443
Govt	12,319	8,680	12,192	8,526	41,717
Total	34,463,622	47,018,649	62,576,271	46,558,340	190,616,882
2004					
AFF	219,231	270,912	444,134	186,296	1,120,573
Min	6,675	5,828	3,030	4,793	20,326
Const	316,960	377,000	368,702	380,580	1,443,242
Manu	197,841	375,725	804,097	314,965	1,692,628
TCPU	3,338,198	2,985,335	2,949,371	3,146,788	12,419,692
Whole	154,053	254,535	263,334	133,454	805,376
Retail	28,539,627	38,707,449	53,817,957	37,982,870	159,047,903
FIRE	961,092	1,132,365	1,283,786	1,003,076	4,380,319
Service	3,641,976	4,891,666	6,082,114	3,568,874	18,184,630
Govt	6,904	8,521	2,880	2,674	20,979
Total	37,382,557	49,009,336	66,019,405	46,724,370	199,135,668

Table 6.6

Soldotna Construction Permitting

Soldotna 4th QUARTER Permit VALUES by Type - 1998-2004 - in \$								
	1998	1999	2000	2001	2002	2003	2004	Annual Change
Residential New	175,000	225,888	270,668	0	176,000	526,191	294,860	-44.0%
Residential Alter/Add	11,660	0	39,500	51,148	11,500	5,000	57,454	1049.1%
Commercial New	300,000	281,905	970,484	0	0	281,491	501,601	78.2%
Commercial Alter/Add	272,500	2,000	122,300	111,500	70,000	60,363	3,850,000	6278.1%
Total	759,160	509,793	1,402,952	162,648	257,500	873,045	4,703,915	438.8%
Annual Change		-32.8%	175.2%	-88.4%	58.3%	239.0%	438.8%	

Table 6.7

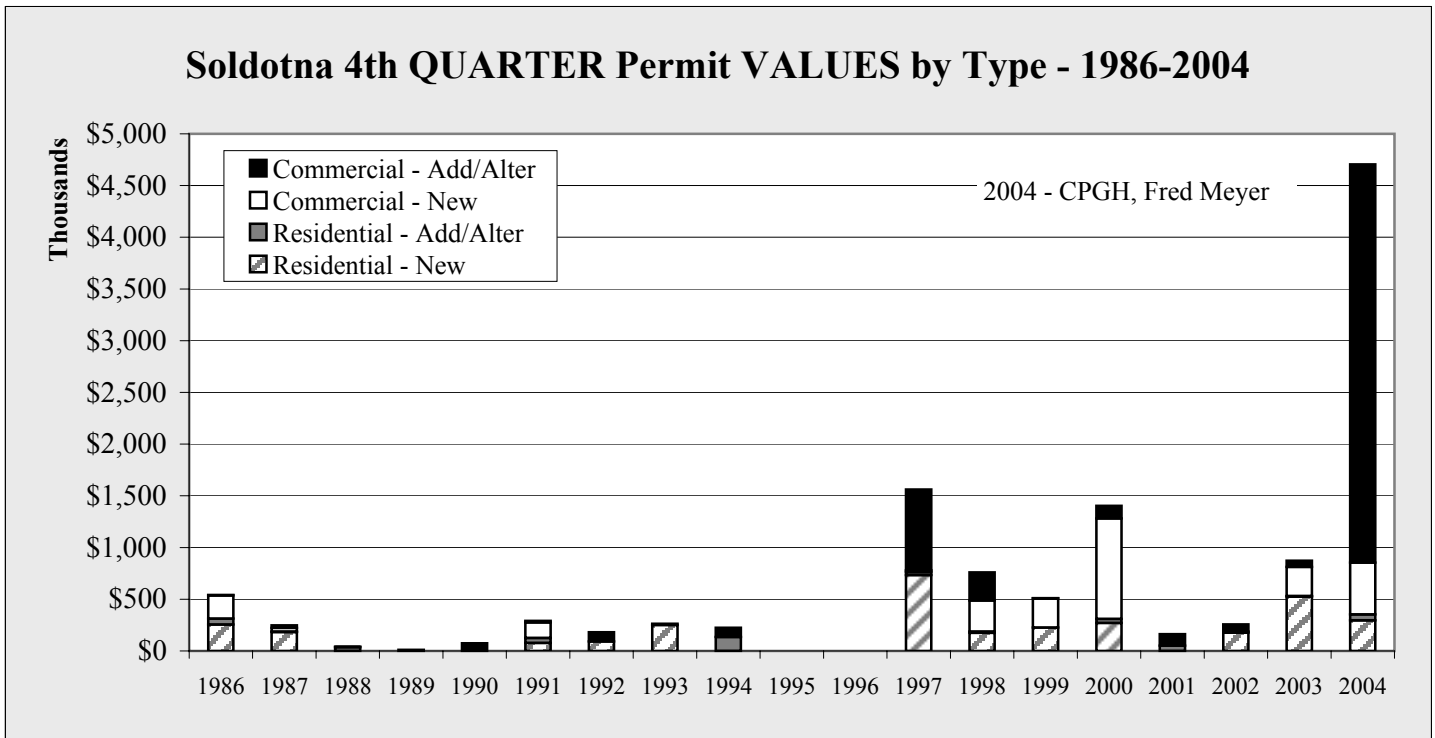

Chart 6.9

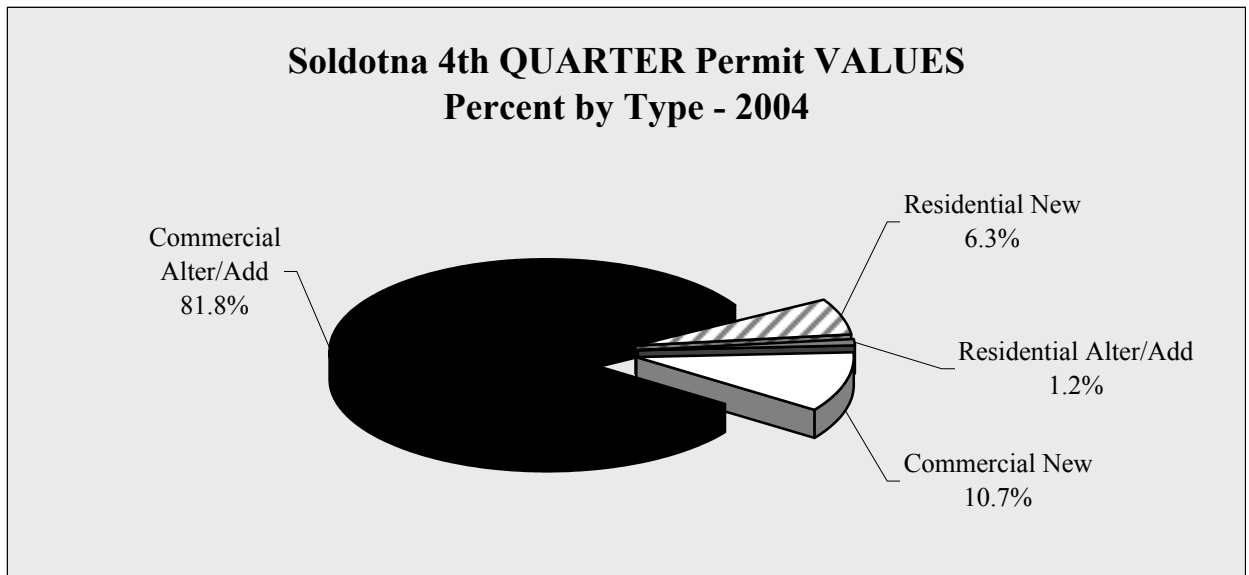

Chart 6.10

Soldotna Construction Permitting

Soldotna 4th QUARTER Permit VOLUME by Type - 1998-2004								
	1998	1999	2000	2001	2002	2003	2004	Annual Change
Residential New	1	2	2	0	1	5	1	-80.0%
Residential Alter/Add	5	0	3	4	2	1	3	200.0%
Commercial New	2	6	7	0	0	2	2	NA
Commercial Alter/Add	6	1	8	7	1	5	2	-60.0%
Total	14	9	20	11	4	13	8	-38.5%
Annual Change		-35.7%	122.2%	-45.0%	-63.6%	225.0%	-38.5%	

Table 6.8

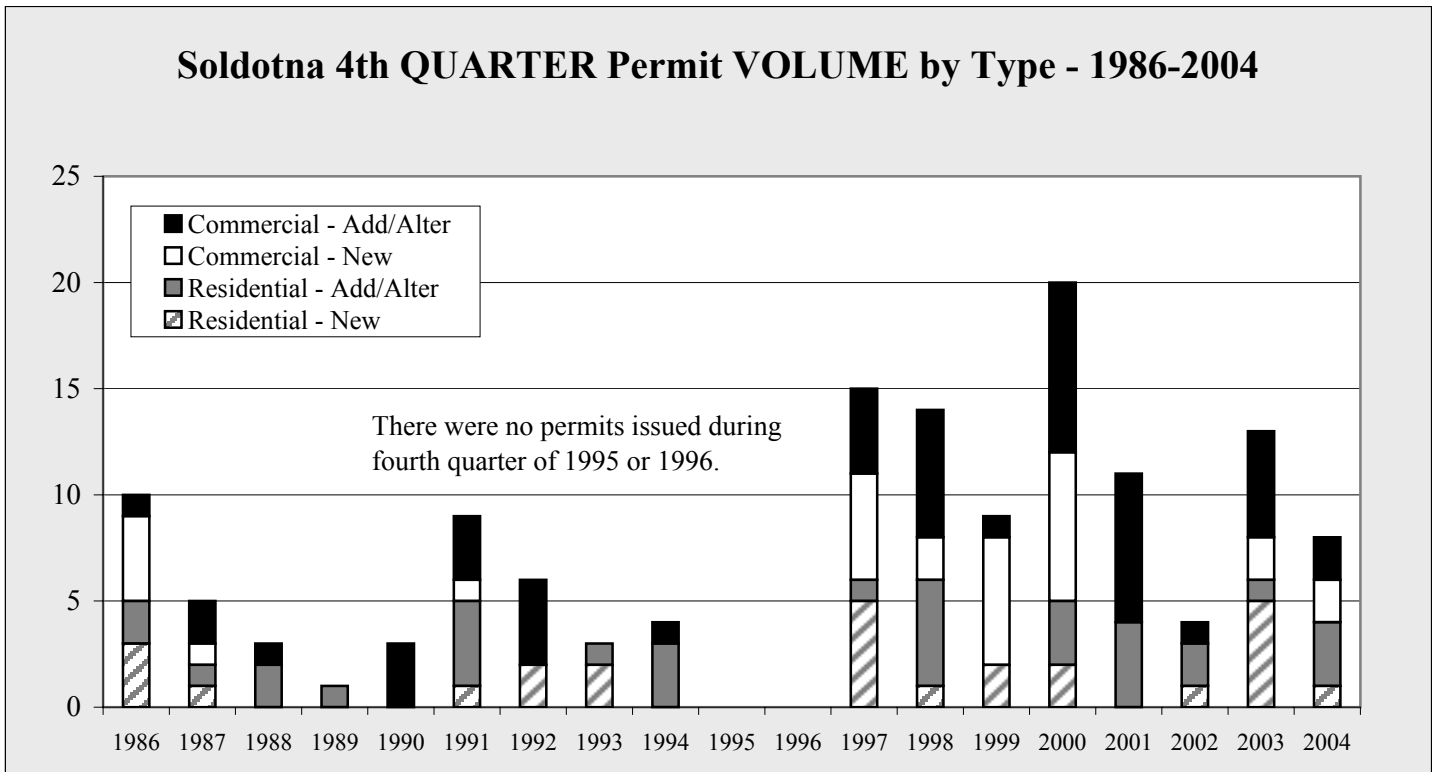

Chart 6.11

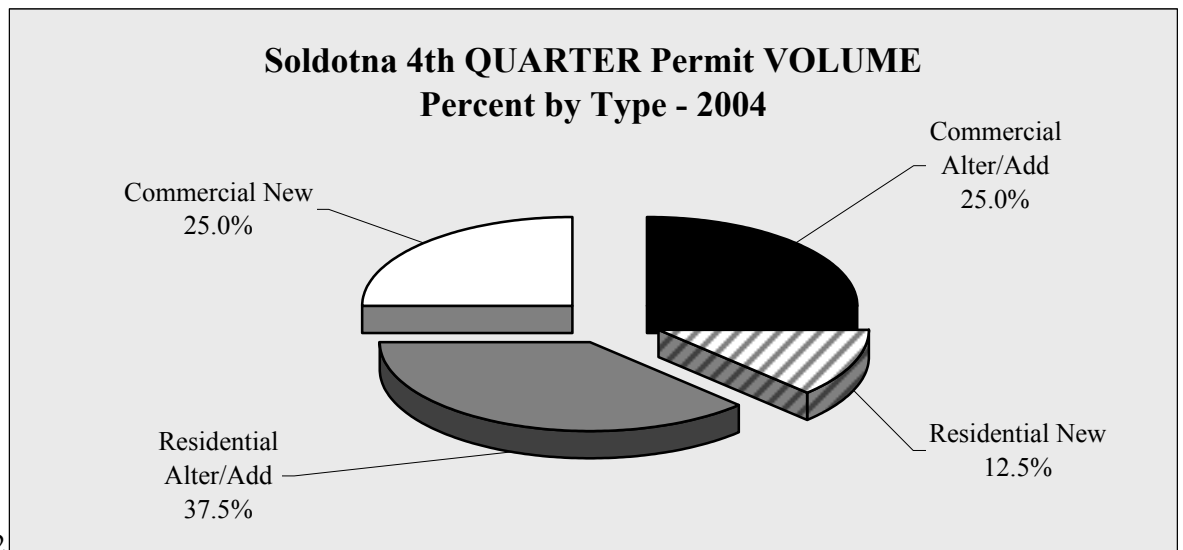

Chart 6.12

Soldotna Construction Permitting

Soldotna ANNUAL Permit VALUES by Type - 1998-2004 - in \$								
	1998	1999	2000	2001	2002	2003	2004	Annual Change
Residential New	2,347,000	3,048,462	2,709,018	3,873,853	3,181,344	3,073,933	3,881,344	26.3%
Residential Alter/Add	237,060	377,228	365,239	357,495	755,187	263,629	277,984	5.4%
Commercial New	5,890,665	5,501,539	3,924,064	3,288,822	4,397,059	3,769,181	28,329,025	651.6%
Commercial Alter/Add	1,147,092	577,891	1,169,099	1,434,802	2,830,304	845,554	4,808,573	468.7%
Total	9,621,817	9,505,120	8,167,420	8,954,972	11,163,894	7,952,297	37,296,926	369.0%
Annual Change		-1.2%	-14.1%	9.6%	24.7%	-28.8%	369.0%	

Table 6.9

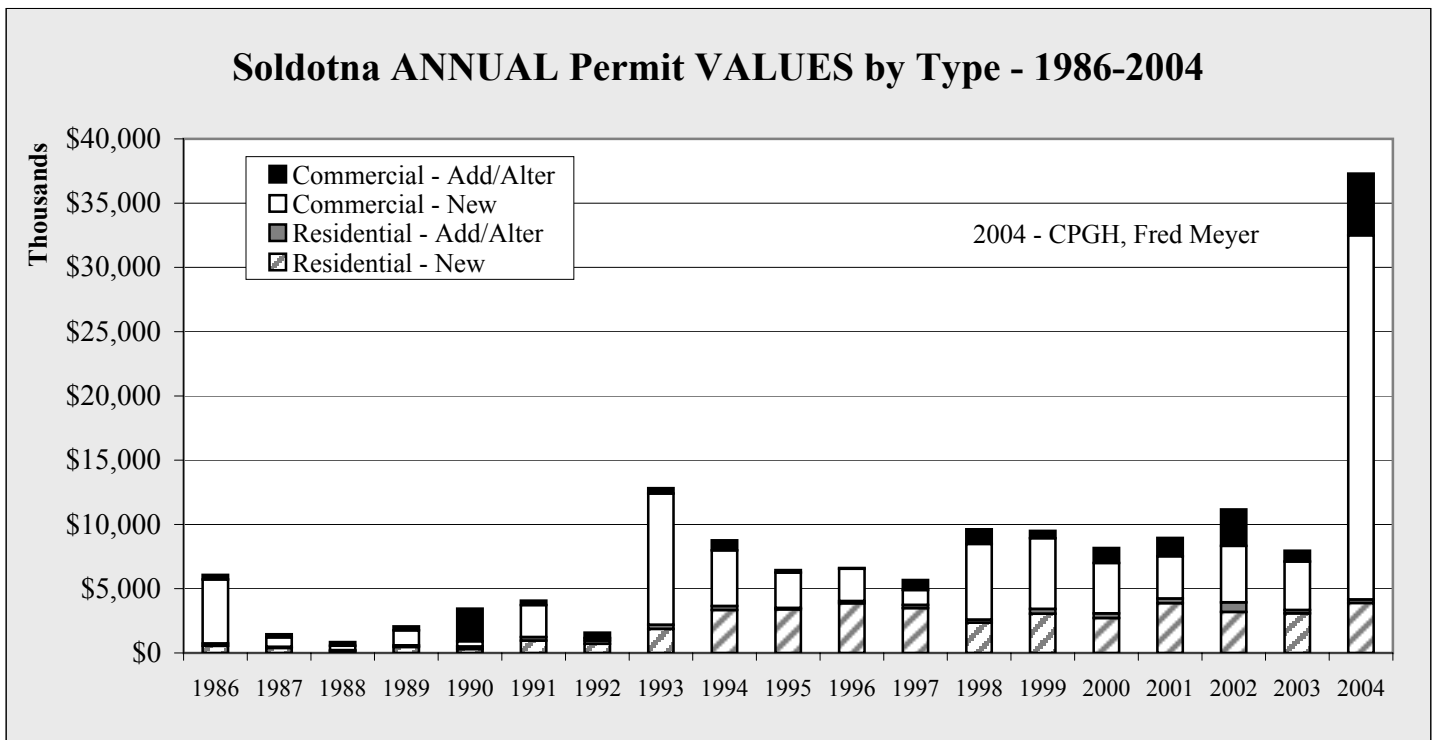

Chart 6.13

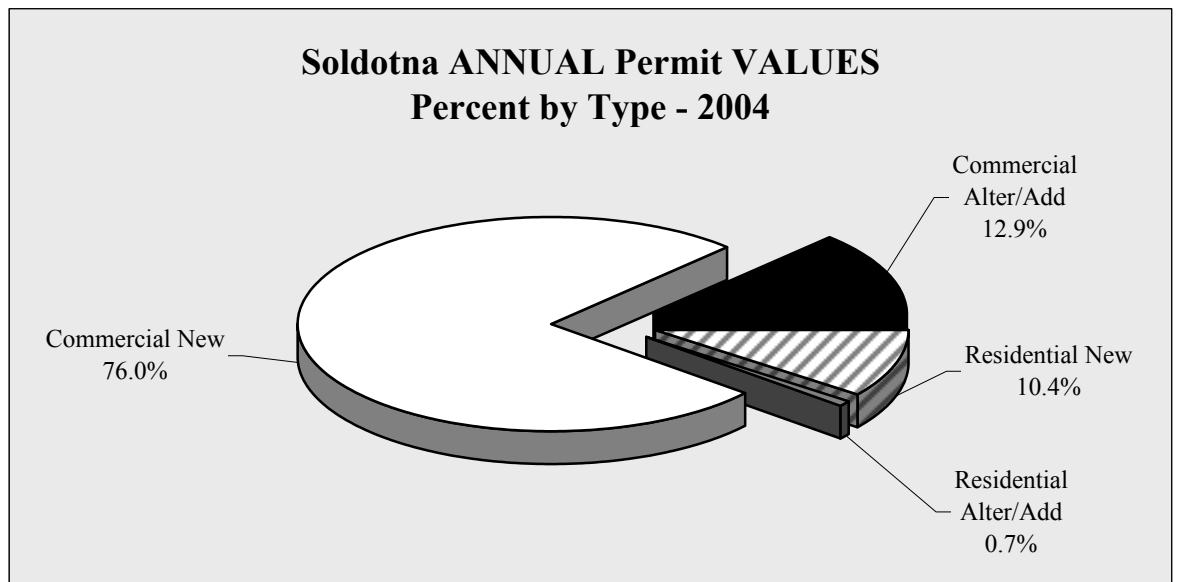

Chart 6.14

Soldotna Construction Permitting

Soldotna ANNUAL Permit VOLUME by Type - 1998-2004

	1998	1999	2000	2001	2002	2003	2004	Annual Change
Residential New	15	19	19	24	24	24	19	-20.8%
Residential Alter/Add	16	16	19	23	20	16	17	6.3%
Commercial New	25	20	18	10	18	16	13	NA
Commercial Alter/Add	21	22	32	36	29	18	18	0.0%
Total	77	77	88	93	91	74	67	-9.5%
Annual Change		0.0%	14.3%	5.7%	-2.2%	-18.7%	-9.5%	

Table 6.10

Soldotna ANNUAL Permit VOLUME by Type - 1986-2004

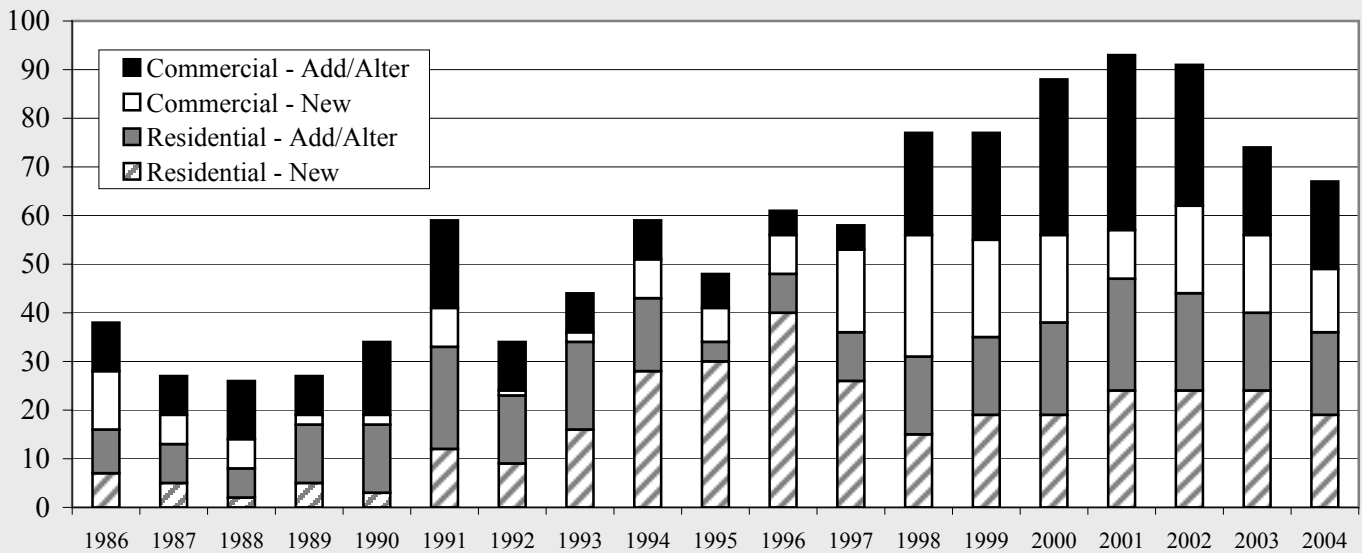

Chart 6.15

**Soldotna ANNUAL Permit VOLUME
Percent by Type - 2004**

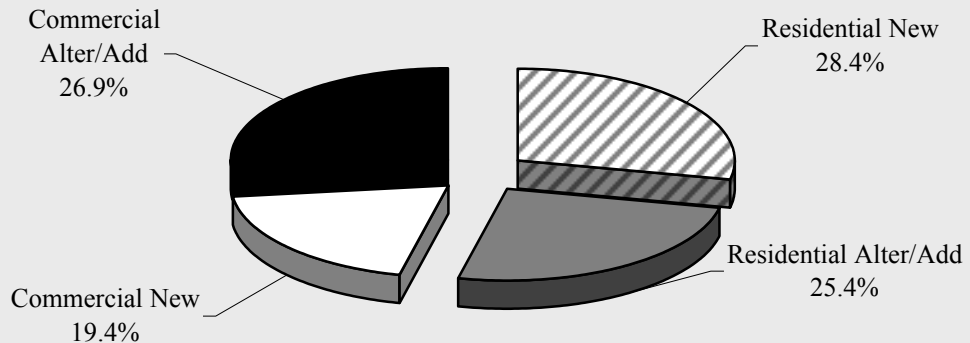

Chart 6.16

Soldotna Construction Permitting

Soldotna Annual Permit VALUES by Type by Quarter - 1997-2004 - in \$					
	1st Quarter	2nd Quarter	3rd Quarter	4th Quarter	Total
1997					
Residential - New	200,000	2,031,205	525,251	733,300	3,489,756
Residential - Add/Alter	70,000	30,900	111,000	30,000	241,900
Commercial - New	28,000	209,500	910,000	16,650	1,164,150
Commercial - Add/Alter	3,000	0	0	780,500	783,500
TOTAL	301,000	2,271,605	1,546,251	1,560,450	5,679,306
1998					
Residential - New	145,000	965,000	1,062,000	175,000	2,347,000
Residential - Add/Alter	0	122,000	103,400	11,660	237,060
Commercial - New	6,552	2,333,400	3,250,713	300,000	5,890,665
Commercial - Add/Alter	78,542	73,000	723,050	272,500	1,147,092
TOTAL	230,094	3,493,400	5,139,163	759,160	9,621,817
1999					
Residential - New	0	1,453,674	1,368,900	225,888	3,048,462
Residential - Add/Alter	54,000	181,361	141,867	0	377,228
Commercial - New	0	2,723,818	2,495,816	281,905	5,501,539
Commercial - Add/Alter	29,696	426,199	119,996	2,000	577,891
TOTAL	83,696	4,785,052	4,126,579	509,793	9,505,120
2000					
Residential - New	373,929	1,520,491	543,930	270,668	2,709,018
Residential - Add/Alter	0	224,674	101,065	39,500	365,239
Commercial - New	434,273	1,583,642	935,665	970,484	3,924,064
Commercial - Add/Alter	270,000	680,549	96,250	122,300	1,169,099
TOTAL	1,078,202	4,009,356	1,676,910	1,402,952	8,167,420
2001					
Residential - New	0	2,363,001	1,510,852	0	3,873,853
Residential - Add/Alter	105,160	151,039	50,148	51,148	357,495
Commercial - New	2,658,578	0	630,244	0	3,288,822
Commercial - Add/Alter	287,480	717,150	318,672	111,500	1,434,802
TOTAL	3,051,218	3,231,190	2,509,916	162,648	8,954,972
2002					
Residential - New	240,849	2,075,293	689,202	176,000	3,181,344
Residential - Add/Alter	86,935	339,286	317,466	11,500	755,187
Commercial - New	714,806	2,601,575	1,080,678	0	4,397,059
Commercial - Add/Alter	163,000	1,987,304	610,000	70,000	2,830,304
TOTAL	1,205,590	7,003,458	2,697,346	257,500	11,163,894
2003					
Residential - New	0	1,899,354	648,388	526,191	3,073,933
Residential - Add/Alter	57,827	130,080	70,722	5,000	263,629
Commercial - New	0	2,116,490	1,371,200	281,491	3,769,181
Commercial - Add/Alter	369,191	88,000	328,000	60,363	845,554
TOTAL	427,018	4,233,924	2,418,310	873,045	7,952,297
2004					
Residential - New	539,297	1,777,087	1,270,100	294,860	3,881,344
Residential - Add/Alter	0	74,809	145,721	57,454	277,984
Commercial - New	4,465,026	1,366,297	21,996,101	501,601	28,329,025
Commercial - Add/Alter	60,000	530,380	368,193	3,850,000	4,808,573
TOTAL	5,064,323	3,748,573	23,780,115	4,703,915	37,296,926

Table 6.11

Soldotna Construction Permitting

Soldotna Annual Permit VOLUME by Type by Quarter - 1997-2004					
	1st Quarter	2nd Quarter	3rd Quarter	4th Quarter	Total
1997					
Residential - New	1	16	4	5	26
Residential - Add/Alter	2	2	5	1	10
Commercial - New	2	3	7	5	17
Commercial - Add/Alter	1	0	0	4	5
TOTAL	6	21	16	15	58
1998					
Residential - New	1	6	7	1	15
Residential - Add/Alter	0	6	5	5	16
Commercial - New	2	11	10	2	25
Commercial - Add/Alter	5	4	6	6	21
TOTAL	8	27	28	14	77
1999					
Residential - New	0	10	7	2	19
Residential - Add/Alter	4	8	4	0	16
Commercial - New	0	8	6	6	20
Commercial - Add/Alter	6	9	6	1	22
TOTAL	10	35	23	9	77
2000					
Residential - New	2	10	5	2	19
Residential - Add/Alter	0	9	7	3	19
Commercial - New	1	3	7	7	18
Commercial - Add/Alter	5	12	7	8	32
TOTAL	8	34	26	20	88
2001					
Residential - New	0	14	10	0	24
Residential - Add/Alter	3	10	6	4	23
Commercial - New	3	0	7	0	10
Commercial - Add/Alter	4	13	12	7	36
TOTAL	10	37	35	11	93
2002					
Residential - New	1	17	5	1	24
Residential - Add/Alter	2	6	10	2	20
Commercial - New	4	9	5	0	18
Commercial - Add/Alter	4	19	5	1	29
TOTAL	11	51	25	4	91
2003					
Residential - New	0	15	4	5	24
Residential - Add/Alter	3	8	4	1	16
Commercial - New	0	6	8	2	16
Commercial - Add/Alter	3	7	3	5	18
TOTAL	6	36	19	13	74
2004					
Residential - New	2	9	7	1	19
Residential - Add/Alter	0	8	6	3	17
Commercial - New	4	3	4	2	13
Commercial - Add/Alter	3	6	7	2	18
TOTAL	9	26	24	8	67

Table 6.12

Soldotna Cost of Food Survey

Cost of food data is collected by the University of Alaska, Fairbanks Cooperative Extension. Each quarter the Cooperative Extension surveys up to three grocers in communities throughout the state to determine the cost of food for one week. Specific guidelines are presented to the surveyors regarding item size and sale price for 104 items. It has been determined that separation of Kenai and Soldotna data would be meaningless therefore data presented relates to both communities.

SOLDOTNA/KENAI									
	Dec-97	Dec-98	Dec-99	Dec-00	Dec-01	Dec-02	Dec-03	Dec-04	Annual Change
Sales Tax (in percent)	5.0	5.0	5.0	5.0	5.0	5.0	5.0	5.0	
Percent of Food Unavailable	0.0	0.0	0.0	0.0	0.0	1.0	0.0	0.0	
Child, 1 year	15.60	16.15	16.16	16.34	17.91	17.78	19.25	18.98	-1.4%
Child, 2 years	0.00	0.00	0.00	0.00	17.91	17.78	18.88	18.79	-0.5%
Children 3-5 years of age	17.10	17.60	17.69	17.92	19.66	19.53	20.73	20.63	-0.5%
Children 6-8 years of age	22.69	23.50	23.52	23.87	26.11	26.03	27.88	27.77	-0.4%
Children 9-11 years of age	25.79	26.57	26.66	27.06	29.63	29.50	31.32	31.20	-0.4%
Males 12-14 years of age	29.16	29.99	30.13	30.49	33.51	33.32	35.30	35.24	-0.2%
Males 15-19 years of age	30.06	30.84	30.97	31.41	34.57	34.37	36.36	36.30	-0.2%
Males 20-50 years of age	29.84	30.67	30.80	31.24	34.39	34.29	36.46	36.42	-0.1%
Males 51 and older	28.52	29.22	29.28	29.83	32.72	32.62	34.95	34.91	-0.1%
Females 12-19 years of age	25.11	25.89	25.89	26.31	28.91	28.72	30.63	30.59	-0.1%
Females 20-50 years of age	26.21	26.83	26.82	27.39	29.97	29.94	31.85	31.85	0.0%
Females 51 and older	25.39	26.06	26.15	26.64	29.28	29.16	30.98	31.01	0.1%
Family of 2, 20-50 years of age	61.66	63.22	63.38	64.49	70.79	70.65	75.14	75.09	-0.1%
Family of 2, 51 years and older	59.30	60.83	61.01	62.11	68.20	67.97	72.53	72.50	0.0%
Family of 4, children 1-5 years	88.74	91.25	91.48	92.89	101.92	101.54	107.93	107.69	-0.2%
Family of 4, children 6-11 years	104.52	107.57	107.81	109.57	122.09	119.76	127.52	127.24	-0.2%
Electricity, 1000 kWh	111.00	120.65	119.34	113.17	122.05	126.11	113.87	121.35	6.6%
Gasoline, auto, 55 gal	76.95	73.87	79.75	97.35	80.12	89.10	100.65	117.15	16.4%
Lumber, 2X4X8'	3.76	3.10	3.69	3.26	3.13	3.28	2.92	3.37	15.4%
Propane, 100 lb. refill	39.48	36.68	37.52	42.24	43.42	43.42	48.14	56.64	17.7%
Sewer & Water, monthly	41.29	41.00	NA	NA	NA	NA	NA	NA	NA

Table 6.13

Soldotna Cost of Food Survey

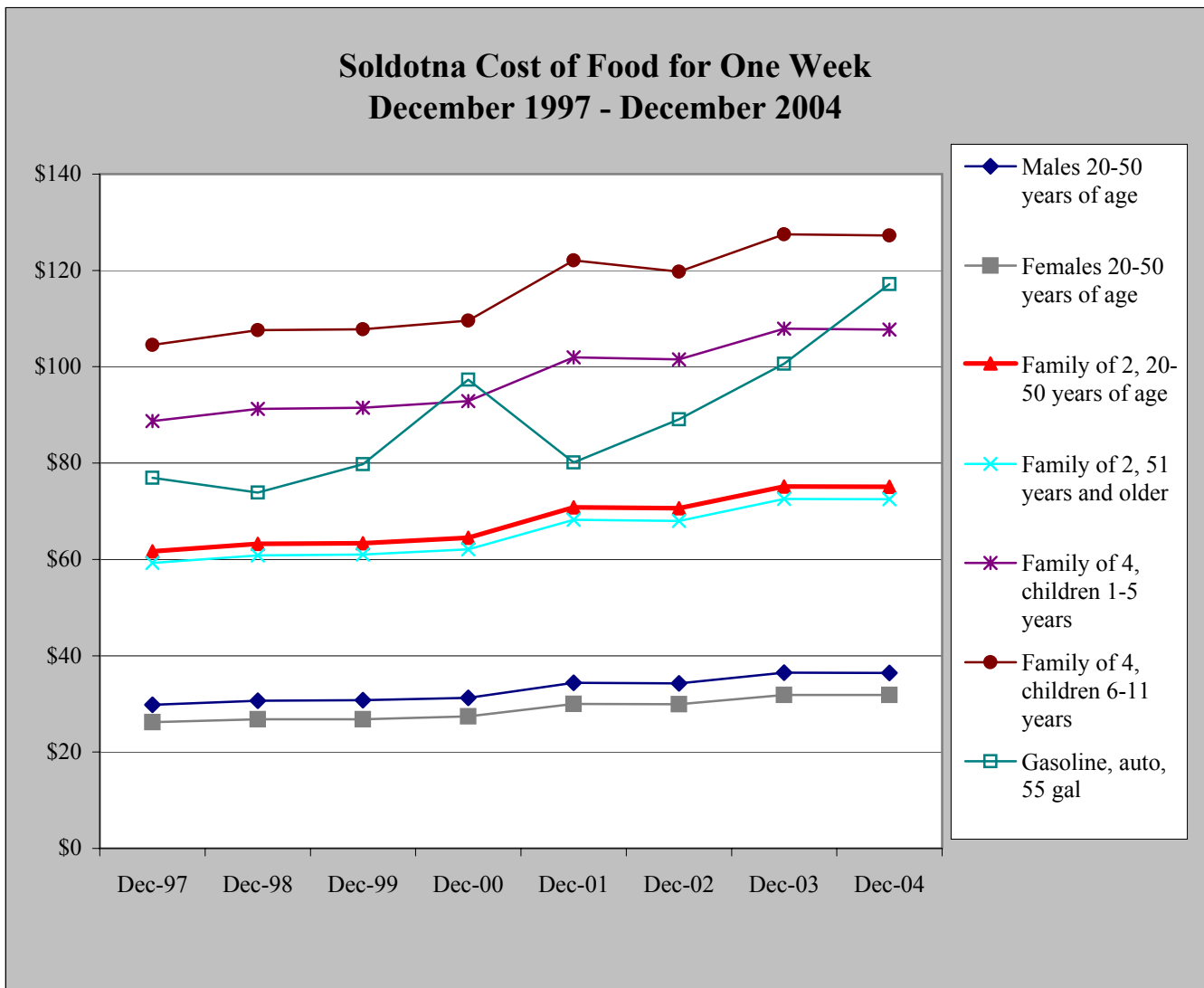

Chart 6.17

KPB Unincorporated Area Sales

KPB Unincorporated 4th Quarter GROSS Sales by Industry - 1998-2004 - in \$								
	1998	1999	2000	2001	2002	2003	2004	Annual Change
AFF	954,784	487,509	598,868	609,830	1,070,350	748,173	2,515,251	236.2%
Min	47,910,745	31,346,369	36,917,017	35,575,897	22,118,005	30,124,765	50,095,736	66.3%
Const	28,821,474	25,024,193	25,851,991	38,492,085	35,349,350	31,126,092	54,103,063	73.8%
Manu	26,647,655	34,645,835	16,081,645	109,743,267	69,309,105	52,415,011	26,651,749	-49.2%
TCPU	18,207,994	20,201,622	17,957,230	20,376,126	14,919,023	14,985,232	26,183,814	74.7%
Whole	23,358,913	23,270,604	23,543,846	25,730,353	26,084,924	28,308,359	32,015,910	13.1%
Retail	29,811,129	30,507,754	31,304,983	37,894,700	35,878,257	37,223,237	37,220,563	0.0%
FIRE	3,967,408	2,701,521	3,084,732	3,240,404	3,638,778	3,892,151	6,667,386	71.3%
Service	13,411,428	14,084,496	16,847,479	18,399,162	15,727,026	15,582,063	20,719,243	33.0%
Govt	285	0	0	0	0	0	1,063	NA
Total	193,091,815	182,269,903	172,187,791	290,061,824	224,094,818	214,405,083	256,173,778	19.5%
Annual Change		-5.6%	-5.5%	68.5%	-22.7%	-4.3%	19.5%	

Table 7.1

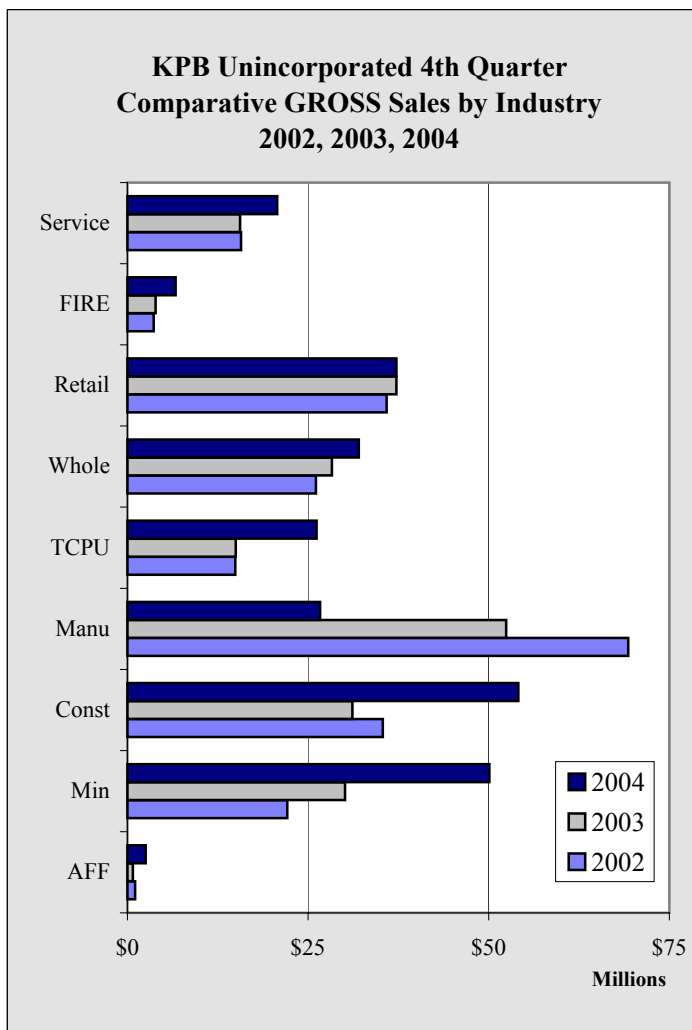

Chart 7.1

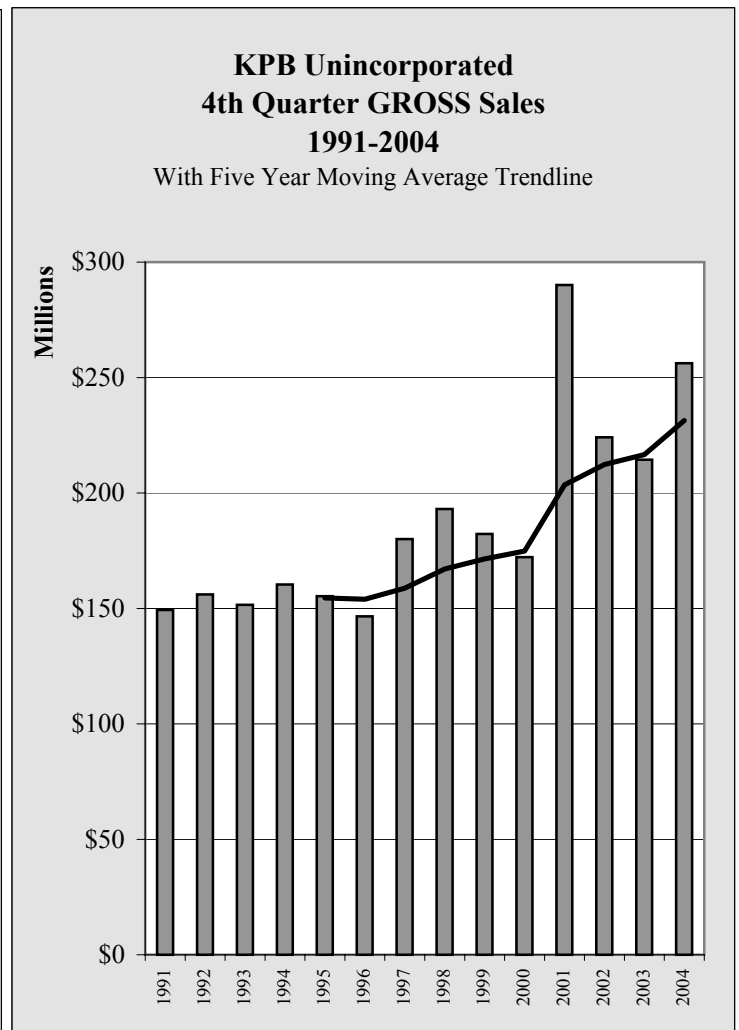

Chart 7.2

KPB Unincorporated Area Sales

KPB Unincorporated 4th Quarter TAXABLE Sales by Industry - 1998-2004 - in \$								
	1998	1999	2000	2001	2002	2003	2004	Annual Change
AFF	320,559	317,244	427,648	354,923	404,614	426,974	458,631	7.4%
Min	1,032,762	1,055,672	1,212,813	1,558,640	1,267,664	1,098,061	1,390,099	26.6%
Const	1,516,259	1,437,474	1,429,921	1,517,251	1,635,784	1,543,865	1,720,962	11.5%
Manu	580,152	589,398	521,819	544,363	464,417	510,322	474,534	-7.0%
TCPU	9,157,762	10,261,420	10,174,859	11,558,896	9,076,753	9,309,842	10,877,910	16.8%
Whole	2,374,713	2,983,283	3,015,555	3,424,874	2,858,282	3,098,926	3,433,552	10.8%
Retail	16,269,944	17,242,257	17,391,414	19,585,581	18,764,270	19,301,155	18,530,848	-4.0%
FIRE	1,296,652	1,200,176	1,301,511	1,508,259	1,434,144	1,483,254	1,524,310	2.8%
Service	6,224,248	5,898,827	6,492,397	6,708,483	6,255,727	6,163,300	6,223,767	1.0%
Govt	285	0	0	0	0	0	1,063	NA
Total	38,773,336	40,985,751	41,967,937	46,761,270	42,161,655	42,935,699	44,635,676	4.0%
Annual Change		5.7%	2.4%	11.4%	-9.8%	1.8%	4.0%	

Table 7.2

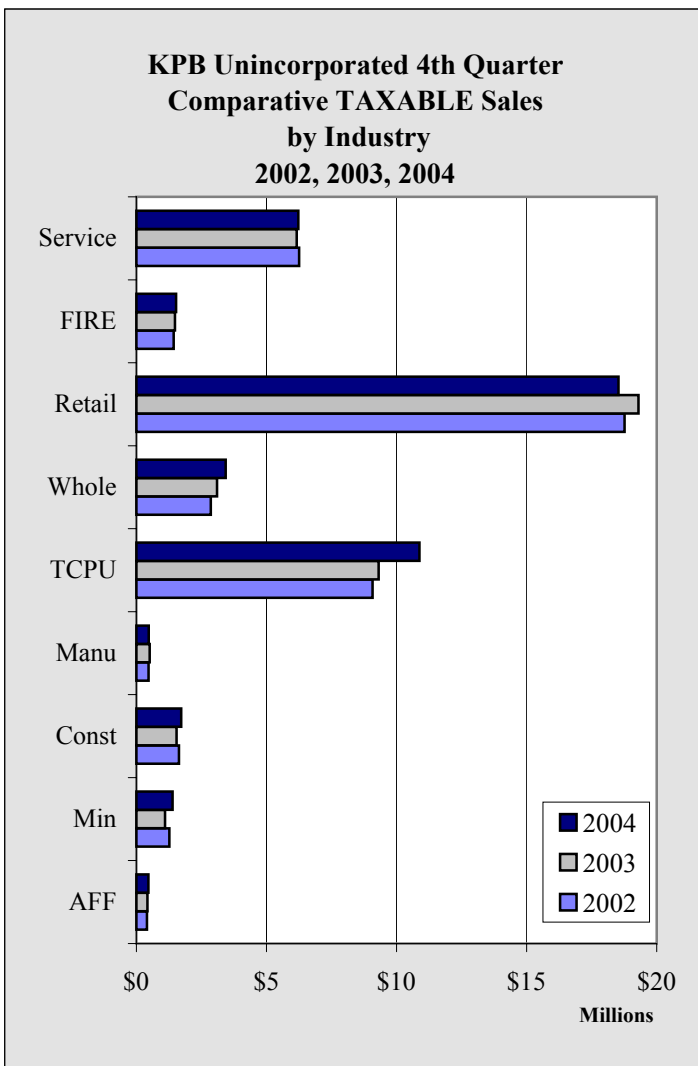

Chart 7.3

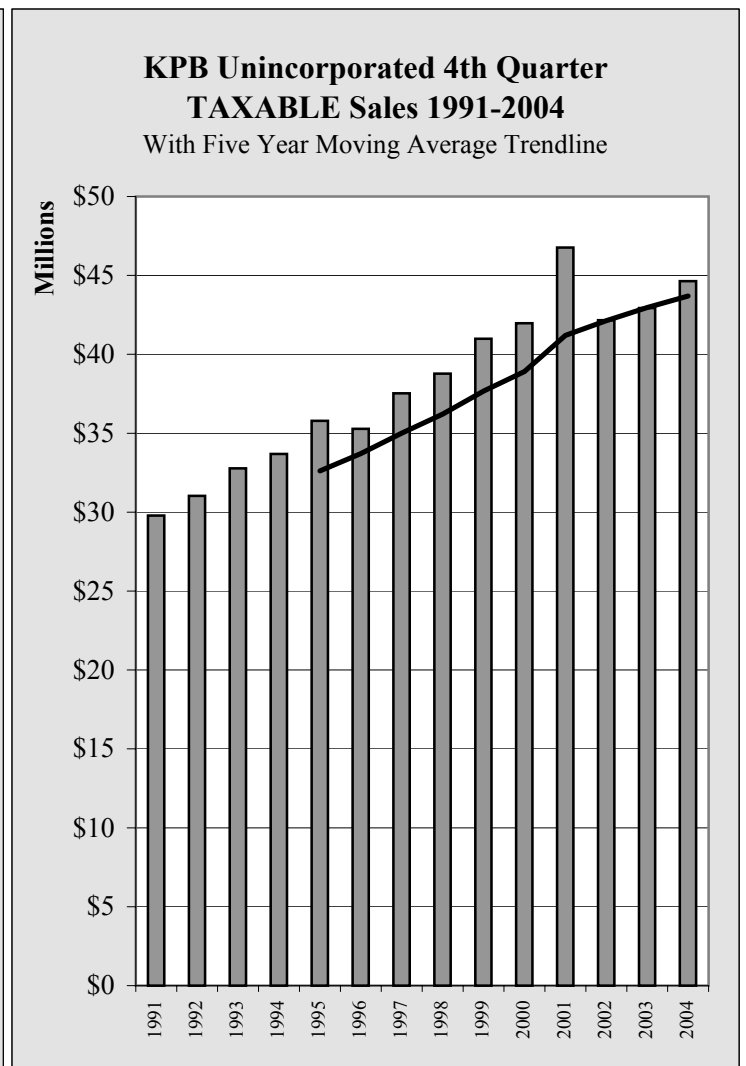

Chart 7.4

KPB Unincorporated Area Sales

KPB Unincorporated Annual GROSS Sales by Industry - 1998-2004 - in \$								
	1998	1999	2000	2001	2002	2003	2004	Annual Change
AFF	6,119,386	2,812,823	2,875,629	3,242,403	4,090,590	4,814,409	5,834,961	21.2%
Min	187,521,559	113,163,554	115,625,431	123,091,789	108,808,400	101,004,267	154,048,838	52.5%
Const	88,142,507	87,808,495	88,853,048	136,499,774	131,261,695	133,880,351	129,235,725	-3.5%
Manu	112,671,455	132,512,994	85,638,574	250,593,511	164,076,655	159,471,272	143,512,989	-10.0%
TCPU	73,567,609	78,647,818	66,837,538	77,388,092	73,138,015	63,786,231	78,080,021	22.4%
Whole	101,466,620	91,041,042	101,310,365	104,710,505	108,334,825	115,986,698	118,470,594	2.1%
Retail	128,963,750	128,644,968	138,967,225	153,029,767	155,130,975	166,755,991	167,178,895	0.3%
FIRE	15,909,441	15,194,140	13,106,195	15,680,221	14,436,076	16,408,311	19,169,921	16.8%
Service	78,651,481	83,322,595	95,090,680	100,412,737	102,659,177	98,547,914	113,940,339	15.6%
Govt	6,585	0	0	0	0	0	13,732	NA
Total	793,020,393	733,148,429	708,304,685	964,648,799	861,936,408	860,655,444	929,486,015	8.0%
Annual Change		-7.5%	-3.4%	36.2%	-10.6%	-0.1%	8.0%	

Table 7.3

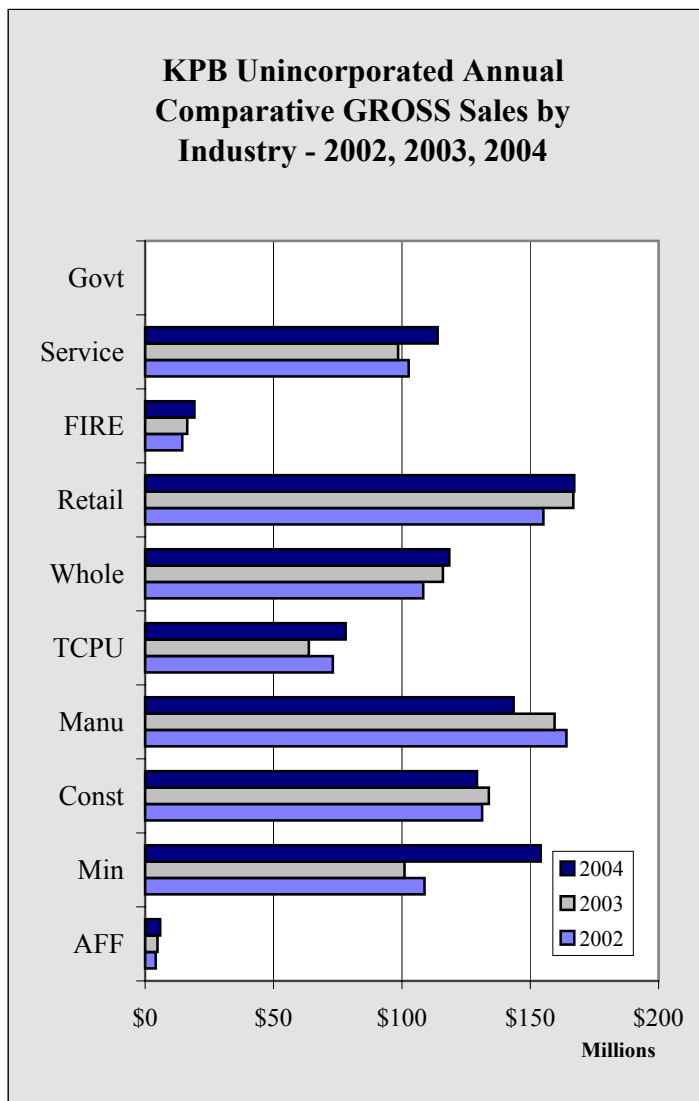

Chart 7.5

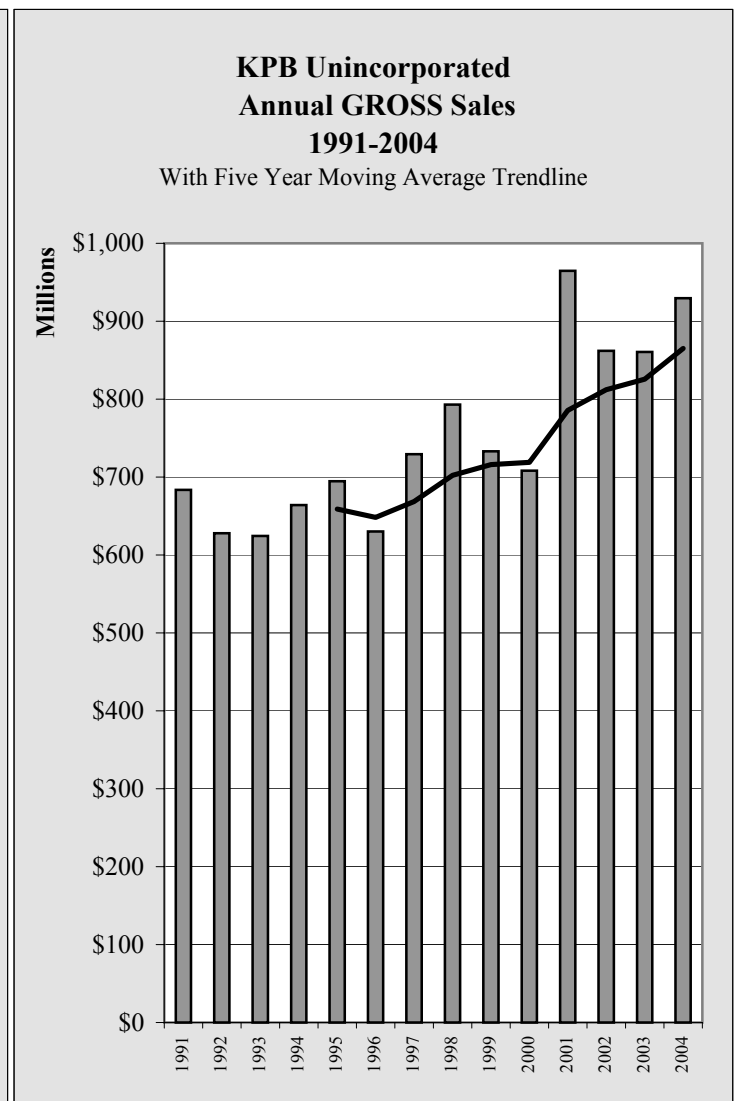

Chart 7.6

KPB Unincorporated Area Sales

KPB Unincorporated Annual TAXABLE Sales by Industry - 1998-2004 - in \$								
	1998	1999	2000	2001	2002	2003	2004	Annual Change
AFF	1,722,929	1,738,057	1,945,844	2,016,782	2,152,460	2,281,300	2,518,234	10.4%
Min	5,144,815	3,724,685	4,434,095	5,598,954	5,598,990	4,655,675	5,215,907	12.0%
Const	5,738,513	5,621,785	5,735,340	6,115,447	6,566,858	6,598,840	6,753,555	2.3%
Manu	3,388,424	3,021,658	3,084,591	3,041,030	2,944,959	2,626,320	2,843,526	8.3%
TCPU	35,992,074	39,160,283	39,092,526	42,147,135	41,606,993	37,098,365	40,090,191	8.1%
Whole	8,733,322	9,868,388	11,100,421	11,675,046	11,425,901	11,820,885	12,654,161	7.0%
Retail	72,533,481	75,119,590	80,838,970	85,853,411	86,150,313	89,695,084	88,439,190	-1.4%
FIRE	5,494,477	5,585,421	5,678,461	6,363,047	6,509,160	7,017,830	6,627,471	-5.6%
Service	40,794,714	43,554,212	47,432,032	48,734,123	47,390,646	47,504,072	51,727,346	8.9%
Govt	6,585	0	0	0	0	0	13,667	NA
Total	179,549,334	187,394,079	199,342,280	211,544,975	210,346,280	209,298,371	216,883,248	3.6%
Annual Change		4.4%	6.4%	6.1%	-0.6%	-0.5%	3.6%	

Table 7.4

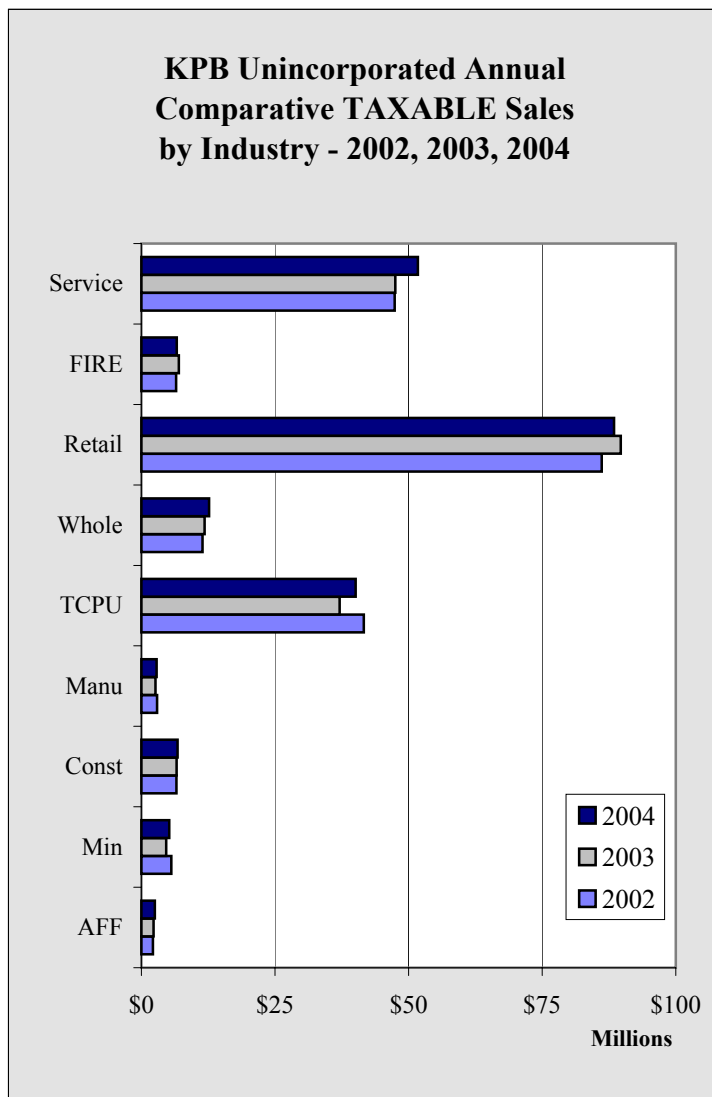

Chart 7.7

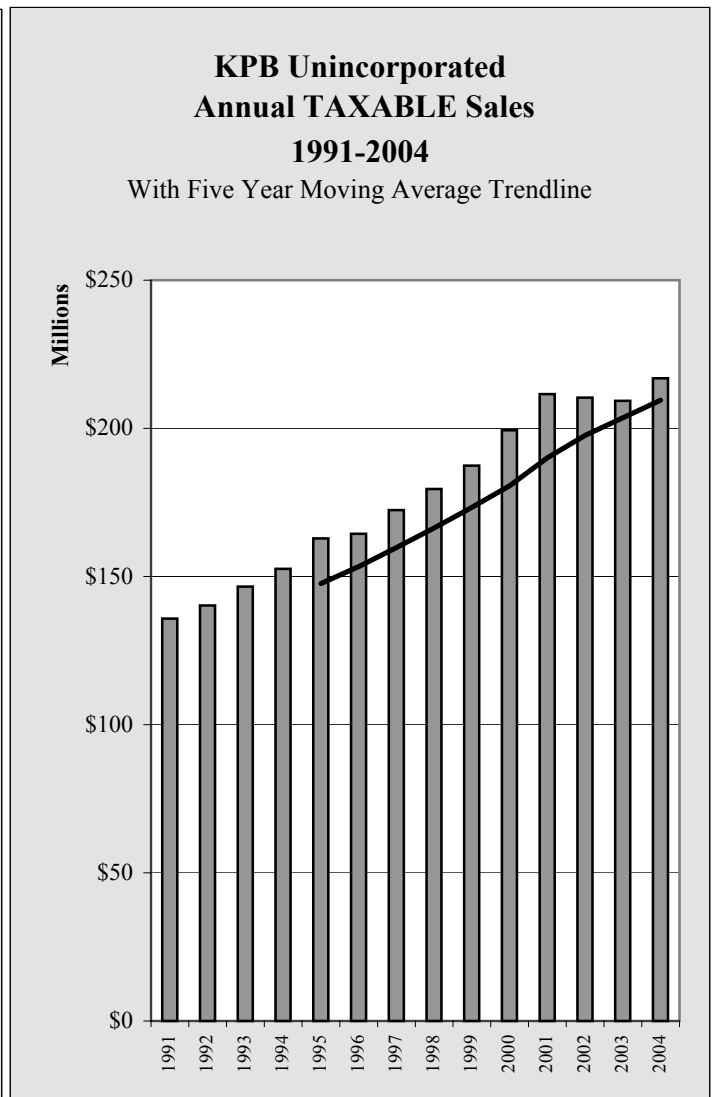

Chart 7.8

KPB Unincorporated Area Sales

KPB Unincorporated GROSS Sales by Industry by Quarter - 2000-2004 - in \$					
	1st Quarter	2nd Quarter	3rd Quarter	4th Quarter	Total
2000					
Ag, Forestry, Fishing	352,282	895,333	1,029,146	598,868	2,875,629
Mining	18,280,459	25,208,965	35,218,990	36,917,017	115,625,431
Construction	12,148,240	20,599,714	30,253,103	25,851,991	88,853,048
Manufacturing	19,962,580	26,397,183	23,197,166	16,081,645	85,638,574
Trans, Comm, Pub Utility	15,686,890	15,437,379	17,756,039	17,957,230	66,837,538
Wholesale	19,617,188	26,003,440	32,145,891	23,543,846	101,310,365
Retail	25,988,141	37,452,274	44,221,827	31,304,983	138,967,225
FIRE	3,038,933	3,698,979	3,283,551	3,084,732	13,106,195
Services	11,590,268	28,284,250	38,368,683	16,847,479	95,090,680
Government	0	0	0	0	0
Total	126,664,981	183,977,517	225,474,396	172,187,791	708,304,685
2001					
Ag, Forestry, Fishing	545,478	1,133,165	953,930	609,830	3,242,403
Mining	27,248,851	25,603,580	34,663,461	35,575,897	123,091,789
Construction	21,706,616	26,755,464	49,545,609	38,492,085	136,499,774
Manufacturing	41,056,398	46,327,693	53,466,153	109,743,267	250,593,511
Trans, Comm, Pub Utility	16,720,929	17,129,688	23,161,349	20,376,126	77,388,092
Wholesale	20,272,119	25,989,525	32,718,508	25,730,353	104,710,505
Retail	27,173,506	41,399,338	46,562,223	37,894,700	153,029,767
FIRE	3,268,311	4,648,250	4,523,256	3,240,404	15,680,221
Services	12,558,002	28,661,264	40,794,309	18,399,162	100,412,737
Government	0	0	0	0	0
Total	170,550,210	217,647,967	286,388,798	290,061,824	964,648,799
2002					
Ag, Forestry, Fishing	447,651	1,142,492	1,430,097	1,070,350	4,090,590
Mining	32,299,252	29,103,164	25,287,979	22,118,005	108,808,400
Construction	24,605,950	30,778,098	40,528,297	35,349,350	131,261,695
Manufacturing	14,954,570	34,871,253	44,941,727	69,309,105	164,076,655
Trans, Comm, Pub Utility	18,420,972	18,167,731	21,630,289	14,919,023	73,138,015
Wholesale	21,943,141	28,469,316	31,837,444	26,084,924	108,334,825
Retail	28,752,133	40,486,870	50,013,715	35,878,257	155,130,975
FIRE	3,214,862	3,704,383	3,878,053	3,638,778	14,436,076
Services	14,742,430	28,996,481	43,193,240	15,727,026	102,659,177
Government	0	0	0	0	0
Total	159,380,961	215,719,788	262,740,841	224,094,818	861,936,408
2003					
Ag, Forestry, Fishing	445,085	2,042,231	1,578,920	748,173	4,814,409
Mining	18,139,022	24,039,296	28,701,184	30,124,765	101,004,267
Construction	22,023,933	35,946,701	44,783,625	31,126,092	133,880,351
Manufacturing	31,662,293	22,050,431	53,343,537	52,415,011	159,471,272
Trans, Comm, Pub Utility	14,598,070	15,634,861	18,568,068	14,985,232	63,786,231
Wholesale	20,948,522	29,652,374	37,077,443	28,308,359	115,986,698
Retail	30,773,844	46,326,072	52,432,838	37,223,237	166,755,991
FIRE	2,801,512	4,574,602	5,140,046	3,892,151	16,408,311
Services	12,971,156	27,700,199	42,294,496	15,582,063	98,547,914
Government	0	0	0	0	0
Total	154,363,437	207,966,767	283,920,157	214,405,083	860,655,444
2004					
Ag, Forestry, Fishing	435,620	1,254,547	1,629,543	2,515,251	5,834,961
Mining	37,672,228	29,692,204	36,588,670	50,095,736	154,048,838
Construction	15,137,343	22,803,329	37,191,990	54,103,063	129,235,725
Manufacturing	21,943,272	7,606,427	87,311,541	26,651,749	143,512,989
Trans, Comm, Pub Utility	14,951,439	16,729,008	20,215,760	26,183,814	78,080,021
Wholesale	21,934,390	28,341,745	36,178,549	32,015,910	118,470,594
Retail	30,044,115	45,752,419	54,161,798	37,220,563	167,178,895
FIRE	3,743,613	3,931,162	4,827,760	6,667,386	19,169,921
Services	14,093,546	31,322,894	47,804,656	20,719,243	113,940,339
Government	6,365	0	6,304	1,063	13,732
Total	159,961,931	187,433,735	325,916,571	256,173,778	929,486,015

Table 7.5

KPB Unincorporated Area Sales

KPB Unincorporated TAXABLE Sales by Industry by Quarter - 2000-2004 - in \$					
	1st Quarter	2nd Quarter	3rd Quarter	4th Quarter	Total
2000					
Ag, Forestry, Fishing	296,108	688,139	533,949	427,648	1,945,844
Mining	869,838	1,046,589	1,304,855	1,212,813	4,434,095
Construction	946,521	1,500,309	1,858,589	1,429,921	5,735,340
Manufacturing	347,573	935,882	1,279,317	521,819	3,084,591
Trans, Comm, Pub Utility	9,905,033	9,290,261	9,722,373	10,174,859	39,092,526
Wholesale	2,513,184	2,624,808	2,946,874	3,015,555	11,100,421
Retail	14,473,470	22,911,114	26,062,972	17,391,414	80,838,970
FIRE	1,230,682	1,494,929	1,651,339	1,301,511	5,678,461
Services	5,113,952	14,713,026	21,112,657	6,492,397	47,432,032
Government	0	0	0	0	0
Total	35,696,361	55,205,057	66,472,925	41,967,937	199,342,280
2001					
Ag, Forestry, Fishing	343,834	755,318	562,707	354,923	2,016,782
Mining	1,159,787	1,265,086	1,615,441	1,558,640	5,598,954
Construction	1,078,729	1,568,794	1,950,673	1,517,251	6,115,447
Manufacturing	408,113	892,944	1,195,610	544,363	3,041,030
Trans, Comm, Pub Utility	10,437,988	9,844,493	10,305,758	11,558,896	42,147,135
Wholesale	2,580,662	2,722,910	2,946,600	3,424,874	11,675,046
Retail	15,269,638	24,014,664	26,983,528	19,585,581	85,853,411
FIRE	1,327,960	1,692,258	1,834,570	1,508,259	6,363,047
Services	5,448,548	15,114,615	21,462,477	6,708,483	48,734,123
Government	0	0	0	0	0
Total	38,055,259	57,871,082	68,857,364	46,761,270	211,544,975
2002					
Ag, Forestry, Fishing	396,517	780,587	570,742	404,614	2,152,460
Mining	1,424,074	1,417,403	1,489,849	1,267,664	5,598,990
Construction	1,132,055	1,657,737	2,141,282	1,635,784	6,566,858
Manufacturing	396,651	881,441	1,202,450	464,417	2,944,959
Trans, Comm, Pub Utility	12,140,823	11,314,077	9,075,340	9,076,753	41,606,993
Wholesale	2,865,394	2,743,971	2,958,254	2,858,282	11,425,901
Retail	16,309,155	23,266,764	27,810,124	18,764,270	86,150,313
FIRE	1,506,676	1,626,536	1,941,804	1,434,144	6,509,160
Services	5,633,539	13,671,993	21,829,387	6,255,727	47,390,646
Government	0	0	0	0	0
Total	41,804,884	57,360,509	69,019,232	42,161,655	210,346,280
2003					
Ag, Forestry, Fishing	360,151	859,055	635,120	426,974	2,281,300
Mining	1,190,125	1,114,615	1,252,874	1,098,061	4,655,675
Construction	1,144,079	1,888,309	2,022,587	1,543,865	6,598,840
Manufacturing	355,143	792,161	968,694	510,322	2,626,320
Trans, Comm, Pub Utility	9,916,712	9,184,673	8,687,138	9,309,842	37,098,365
Wholesale	2,716,115	2,861,811	3,144,033	3,098,926	11,820,885
Retail	16,136,823	25,345,609	28,911,497	19,301,155	89,695,084
FIRE	1,452,777	1,841,058	2,240,741	1,483,254	7,017,830
Services	5,055,788	14,212,739	22,072,245	6,163,300	47,504,072
Government	0	0	0	0	0
Total	38,327,713	58,100,030	69,934,929	42,935,699	209,298,371
2004					
Ag, Forestry, Fishing	400,257	913,942	745,404	458,631	2,518,234
Mining	977,166	1,018,997	1,829,645	1,390,099	5,215,907
Construction	1,180,160	1,735,881	2,116,552	1,720,962	6,753,555
Manufacturing	367,901	785,263	1,215,828	474,534	2,843,526
Trans, Comm, Pub Utility	10,257,135	8,918,293	10,036,853	10,877,910	40,090,191
Wholesale	3,269,436	2,795,501	3,155,672	3,433,552	12,654,161
Retail	16,098,382	24,688,232	29,121,728	18,530,848	88,439,190
FIRE	1,481,302	1,678,637	1,943,222	1,524,310	6,627,471
Services	4,980,414	15,603,491	24,919,674	6,223,767	51,727,346
Government	6,300	0	6,304	1,063	13,667
Total	39,018,453	58,138,237	75,090,882	44,635,676	216,883,248

Table 7.6

KPB Local Officials Directory

Officials of the various governing bodies within the Kenai Peninsula Borough are listed on the following pages.

The officials listed are those who held office at the time of printing of the report. Annual elections for public officials are held each October. For information regarding current public officials, check the appropriate website.

Kenai Peninsula Borough - <http://www.borough.kenai.ak.us/>

Kenai Peninsula Borough School District - <http://www.kpbsd.k12.ak.us/>

City of Homer – <http://www.ci.homer.ak.us/>

City of Kenai – <http://www.ci.kenai.ak.us/>

City of Seldovia – <http://www.xyz.net/~seldovia/>

City of Seward – <http://www.cityofseward.net/>

City of Soldotna - <http://www.ci.soldotna.ak.us/>

KPB Local Officials Directory

Kenai Peninsula Borough Mayors

Kenai Peninsula Borough

Mayor Dale Bagley
144 North Binkley
Soldotna, AK 99669
907-262-4441

City of Homer

Mayor Jack Cushing
491 East Pioneer Ave.
Homer, AK 99603
907-235-8121

City of Kachemak

Mayor Philemon Morris
PO Box 598
Homer, AK 99603
907-235-8897

City of Kenai

Mayor Pat Porter
210 Fidalgo Street, Suite 200
Kenai, AK 99611
907-283-7535

City of Seldovia

Mayor Dick Wyland
Drawer B
Seldovia, AK 99663
907-234-7643

City of Seward

Mayor Vanta Shafer
PO Box 167
Seward, AK 99664
907-224-4046

City of Soldotna

Mayor Dave Carey
177 North Birch
Soldotna, AK 99669
907-262-9107

KPB Local Officials Directory

Kenai Peninsula Borough Mayor & Assembly

144 N. Binkley - Soldotna, Alaska 99669

Phone 907-262-4441

Administration Fax: 907-262-1892 - Assembly/Clerk Fax: 907-262-8615

Assembly e-mail: assemblyclerk@borough.kenai.ak.us

Office/District	Name/Address	Phone/Fax/e-mail	Term Expires	Previously Elected
Borough Mayor	Dale Bagley 144 N. Binkley Soldotna, AK 99669	714-2150 W 262-3160 H 262-8616 Fax dbagley@borough.kenai.ak.us	2005	1999, 2002
Assembly 1 - Kalifornsky	Dan Chay 37306 Cetacea Lane Kenai, AK 99611	283-9227 H 283-7588 Fax chay@alaska.com	2006	2003
Assembly 2 - Kenai	Betty Glick POB 528 Kenai, AK 99611-8823	283-7644 H bjg@alaska.net	2005	2002
Assembly 3 - Nikiski	Gary Superman - President POB 8425 Nikiski, AK 99635	776-8448 H 776-8098 Fax gsuperman@gci.net	2007	2001, 2004
Assembly 4 - Soldotna	Pete Sprague 188 Farnsworth Blvd. Soldotna, AK 99669	262-4073 H 262-4073 Fax psprague@alaska.net	2007	1998, 2001, 2002
Assembly 5 - Sterling/ Funny River	Grace Merkes P.O. Box 8 Sterling, AK 99672	262-9811 H merkes@ptialaska.net	2005	1991, 1992, 1993, 1996, 1999, 2002
Assembly 6 - East Peninsula	Ron Long - Vice President P.O. Box 2464 Seward, AK 99664	224-7068 H 224-5707 Fax rlms@ptialaska.net	2006	2000, 2003
Assembly 7 - Central	Paul Fischer P.O. Box 889 Kasilof, AK 99610	262-9269 H 262-4902 Fax akfischer@alaska.com	2007	1998, 2001, 2002,
Assembly 8 - Homer	Chris Moss P.O. Box 115 Homer, Alaska 99603	235-8053 H 235-8053 Fax cmoss@xyz.net	2005	1999, 2002
Assembly 9 - South Peninsula	Milli Martin PO Box 2652. Homer, AK 99603	235-6652 H 235-6652 Fax millimom@xyz.net	2006	2000, 2002, 2003
Borough Attorney	Colette Thompson 144 N. Binkley Soldotna, AK 99669	714-2120 262-8686 Fax		
Borough Clerk	Linda S. Murphy 144 N. Binkley Soldotna, AK 99669	714-2161 262-8615 Fax assemblyclerk@borough.kenai.ak.us		

KPB Local Officials Directory

KENAI PENINSULA BOROUGH PLANNING COMMISSION MEMBERS

2004

Member	Contact Information	Term Expires
CHAIRMAN		
Philip Bryson P.O. Box 1041 Kenai, Alaska 99611-1041	283-4672 work 283-4428 home	Kenai City Term Expires July 31, 2007
VICE CHAIRMAN		
Tom Clark P.O. Box 962 Anchor Point, Alaska 99556-0962	235-2887 home	Anchor Point/Ninilchik Term Expires July 31, 2007
PARLIAMENTARIAN		
Patricia Hartley 144 North Binkley Soldotna, Alaska 99669	714-2215 - work	Planning Administrative Assistant
Dick Troeger 372 Lupine Street Soldotna, Alaska 99669	262-5387 - home	Soldotna City Term Expires July 31, 2005
Dr. Rick Foster P.O. Box 3328 Homer, AK 99603-3328	235-9100 - home	Homer City Term Expires July 31, 2007
Mari Anne Gross 57485 Clover Avenue Homer, Alaska 99603	235-7330 - home	Southwest Borough Term Expires July 31, 2005
Lynn Hohl P.O. Box 333 Seward, Alaska 99664-0333	224-7300 - home	Seward City Term Expires July 31, 2005
William Hutchinson P.O. Box 2585 Soldotna, Alaska 99669-2585	262-5256 - home	Ridgeway Term Expires July 31, 2007
James Isham P.O. Box 51 Soldotna, Alaska 99669-0051	262-9200 - home	Sterling Term Expires July 31, 2006
Brent Johnson 20773 Porcupine Lane Clam Gulch, Alaska 99568-9713	262-4763 - home	Kasilof/Clam Gulch Term Expires July 31, 2006
Blair Martin P.O. Box 1776 Soldotna, Alaska 99669-1776	283-5227 - home	Kalifornsky Beach Term Expires July 31, 2006
Mark Massion P.O. Box 203 Seldovia, Alaska 99663-0278	234-7575 - home	Seldovia City Term Expires July 31, 2006
Todd Petersen P.O. Box 651 Seward, Alaska 99664-0651	288-5050 - home 224-3350 - work 224-2388 - work fax	East Peninsula Term Expires July 31, 2007
Ray Tauriainen P.O. Box 8678 Nikiski, Alaska 99635-8678	776-8885 - home	Northwest Borough Term Expires July 31, 2005

Email address for the Planning Commission: planning@borough.kenai.ak.us

Fax Number for the Planning Commission: 907-262-8618

KPB Local Officials Directory

Kenai Peninsula Borough School District

148 North Binkley Street
Soldotna, AK 99669
907-262-5846

Board of Education

Lorraine Crawford, President	36615 Chinula Drive Kenai, AK 99611	907-283-9271	Term Expires 2007
Sandra Wassilie, Vice President	PO Box 1576 Seward, AK 99664	907-224-3950	Term Expires 2007
Debra Mullins, Clerk	53630 Redoubt Drive Kenai, AK 99611	907-776-5250	Term Expires 2005
Margaret Gilman, Treasurer	216 Susianna St. Kenai, AK 99611	907-283-0860	Term Expires 2006
Marty Anderson	P.O. Box 1388 Sterling, AK 99672	907-260-7500	Term Expires 2006
Nels Anderson, MD	303 Diane Lane Soldotna, AK 99669	907-262-3280	Term Expires 2005
Debbie Brown	P.O. Box 592 Kasilof, AK 99610	907-262-4551	Term Expires 2005
Deborah Germano	P.O. Box 1511 Homer, AK 99603	907-235-2538	Term Expires 2006
Sunni Hilts	P.O. Box 144 Seldovia, AK 99663	907-234-7692	Term Expires 2007
Student Representative DJ Tyson	Kenai Central High School 9853 Kenai Spur Hwy Kenai, AK 99611		Term Expires 2005

Administration

Dr. Donna Peterson, Superintendent of Schools
Sam Stewart, Assistant Superintendent
Gary Whiteley, Assistant Superintendent of Instruction
Melody Douglas, Chief Financial Officer
Tim Peterson, Director of Human Resources

KPB Local Officials Directory

Kenai Peninsula Borough Department Directors

Switchboard	262-4441
Assessing	Shane Horan
Capital Projects	Rob Robson
Clerk	Linda Murphy
Finance	Scott Holt
Legal	Colette Thompson
Maintenance	Dave Tressler
Resource Planning	Max Best
Road Maintenance	Gary Davis
Solid Waste	Cathy Mayer

Kenai Peninsula Borough Economic Development Agencies

KPB Community & Economic Development Division - CEDD

Jack Brown – Business Manager
43335 Kalifornsky Beach Road, Suite 16
Soldotna, AK 99669
907-714-2336

KP Economic Development District - EDD

14790 Kenai Spur Highway, Ste. 106A
Kenai, AK 99611
907-283-3335

Kenai Peninsula Tourism Marketing Council

14790 Kenai Spur Highway, Ste. 103A
Kenai, AK 99611
907-262-5229

KP Resource Conservation and Development, Inc.

Trading Bay Plaza, Suite 150
PO Box 800, Kenai, AK 99611
907-283-7493