



KENAI PENINSULA BOROUGH
QUARTERLY REPORT
OF KEY ECONOMIC INDICATORS

For Fiscal Quarter Ending December 30, 2007
Published April, 2008

John J. Williams
Borough Mayor

Compiled and Produced By
Jeanne Camp, Economic Analyst
144 North Binkley Street
Soldotna, Alaska 99669
Phone – 907-714-2336

See this document on the web – <http://www.borough.kenai.ak.us>
Using the 'Economic Development' link

Index

	Page #
Introduction-----	2
Executive Summary-----	4
Kenai Peninsula Borough	
Sales – KPB Finance Department-----	13
Construction – Cities of Homer, Kenai, Seldovia, Seward and Soldotna -----	27
Employment – State of Alaska Department of Labor & Workforce Development--	36
Demographics – U.S. Census Bureau, AK Dept of Labor & Workforce Dev. -----	38
Homer	
Sales – KPB Finance Department-----	45
Construction – City of Homer -----	55
Kenai	
Sales – KPB Finance Department-----	61
Construction – City of Kenai -----	71
Seldovia	
Sales – KPB Finance Department-----	77
Construction – City of Seldovia -----	87
Seward	
Sales – KPB Finance Department-----	93
Construction – City of Seward-----	103
Soldotna	
Sales – KPB Finance Department-----	109
Construction – City of Soldotna -----	119
Other	
Sales – KPB Finance Department-----	125
Directory of Local Officials-----	135

Data Sources are listed in each subsection.

Introduction

Kenai Peninsula Borough (KPB) staff develops quarterly reports presenting regional economic data for use by businesses, agencies, and other entities to aid in planning and management decisions.

The publication is divided into eight sections: Kenai Peninsula Borough, Homer, Kenai, Seldovia, Seward, Soldotna, Other KPB and a Local Officials Directory.

To provide unity within the document, certain conventions are applied:

- In the real estate section, the following abbreviations apply:
 - RN - Residential New
 - RA - Residential Alteration/Addition
 - CN - Commercial New
 - CA - Commercial Alteration/Addition

Public projects are included in the commercial categories while permits issued for signs are not presented in this publication.

Due to concerns of releasing proprietary sales information, lines of business (LOB) have been grouped into fewer categories than presented in recent documents. LOB category abbreviations, and LOB's included in each are listed below.

RSRC	Resource Production	Agriculture, Forestry, Fishing & Hunting Mining - (Includes oil and gas exploration, production, gravel) Timbering
SALES	Sales	Restaurant & Bar Retail
CONST	Construction	Construction
PROP	Rentals	Rental Commercial Property Rental Residential Property Rental Personal Property Rental Non-residential Properties Trailer Court
TOUR	Tourism	Arts, Entertainment & Recreation Guiding Land Guiding Water Accommodation, Food Services
SERV	Services	Administration, Support, Waste Management & Remediation Educational Services Finance & Insurance Information Other Services Remediation Services Telecommunications
PROF	Professional	Health & Social Services Management of Companies & Enterprises Professional, Scientific & Technical
UTIL	Utilities	Utilities
TRAN	Transport/ Warehouse	Transportation & Warehousing
MFG	Manufacturing	Manufacturing - (Includes oil and gas manufacturing, fish processing)
WHSL	Wholesale	Wholesale
GOV	Public Administration	Public Administration - (Includes Native Organizations)

- Information sources for each section of the publication are listed in the index.
- General information applicable to all sections is provided in the KPB section.
- Percentages of parts may not total 100%, due to rounding.

Information presented assists in decision-making by providing economic and demographic information in graphic, table and text form. Data is used by local and state government officials; local, state and federal agencies; businesses within the KPB and elsewhere; and private citizens.

Data is received from various sources and is subject to change as updates, revisions and corrections are received. The KPB makes no claims to accuracy or completeness of information provided. Only summary information is published. For further detail, contact Jeanne Camp, Economic Analyst, Kenai Peninsula Borough, 907-714-2336, or the data source listed in the index.

Reports are available electronically at <http://www.borough.kenai.ak.us>. Select the Economic Development link in the left hand column, then Publications. Select the publication of interest.

To add or delete your name to the distribution list that alerts interested parties to the availability of new data, please email jcamp@borough.kenai.ak.us or call 907-714-2336. Be certain to identify yourself and the complete email address to be added or deleted. The distribution list is used for notification of website updates, website availability of quarterly data and the annual *Situations and Prospects* in pdf format, and notification of data corrections. The list will not be used for any purpose other than the three stated above.

Kenai Peninsula Borough staff appreciates contributions from the entities listed below, each of which provided data for this publication.

Alaska Department of Labor and Workforce Development (AK DOLWD)
City of Homer
City of Kenai
City of Seldovia
City of Seward
City of Soldotna
KPB Finance Department, Sales Tax Division

The writer wishes to thank those persons who gave of their time to review this document, finding errors and making suggestions that result in a more professional and accurate document. Those individuals include Betty Glick, former KPB Assembly member; Jane Stein, former Soldotna City Council Member and Sylvia Vinson, KPB Planning Department staff.

Executive Summary

Briefly. Fourth quarter taxable sales increased 2.8% while gross sales decreased 7.3% when compared to fourth quarter 2006. Construction permitting activity was slow in three of five communities but strength in Seward and Soldotna resulted in borough-wide values increasing 224.2% over 2006. Permit volume decreased 10.7%. Unemployment data, both fourth quarter and annual, report new bests with the largest annual monthly average labor force, the highest employment, the lowest annual unemployment, and the lowest unemployment rate since the calculation standard was modified in 2000. Unemployment detail is not an actual count, but rather an estimate based upon survey responses and calculations used in the standardized model.

Sales. Fourth quarter 2007 gross sales, \$858,142,418, were \$67,588,727 less than fourth quarter 2006 when the total reached \$925,731,145. Each of the four largest cities experienced decreasing gross sales. However, taxable sales continued to climb, reaching \$194,896,650, gaining \$5,391,051 over the 2006 fourth quarter total of \$189,505,599. Seward was the only KPB area with decreasing quarterly taxable sales.

Construction. Construction permit values gained 224.2% and totaled \$22,494,245 when compared to \$6,938,082 one year ago, easily the highest fourth quarter on record and third highest annual value on record. The recent annual record and second high values of \$84,041,457 in permit value was issued during 2004 while the 2006 total value reached \$80,230,660. The new Long Term Care Facility permitted in Seward accounted for 80.0% of total quarterly value. Fourth quarter activity yielded 56 permits, third highest volume since permitting began during 1988. There were 62 permits issued during 2003 and 61 permits were issued during 1997. During 2007 there were 334 permits issued, fourth highest behind 2002 when 351 were issued, 2005 with 338, and 2003 with 336 permits.

Unemployment. Four sets of unemployment data are estimated each month, based upon survey data which is entered into a federal standardized model. On a quarterly basis, all four measures marked improvement and, for the year, each set record bests. The annual monthly average labor force stood at 25,529, increasing by 111 persons over one year ago. Unemployment decreased from the annual monthly average of 2,101 persons to 1,967 during 2007. The corresponding annual average monthly unemployment rate dropped to 7.8% from the 2006 average of 8.3%. Lastly, employment increased to a 2007 monthly average of 23,563 persons from the 2006 annual monthly average estimate of 23,317.

The State of Alaska is planning its 50th Anniversary of Statehood celebration which provides an excellent opportunity for communities to draw visitors for special celebration activities. Three main events are planned. On May 28, 2008, Fairbanks will commemorate the date Congress passed the Alaska Statehood Act; on July 4, 2008, Juneau will celebrate the July 7th date President Eisenhower signed the Alaska Statehood Act into law; and Anchorage will hold a grand finale ball on January 3, 2009, celebrating the date President Eisenhower's signed the proclamation admitting Alaska

Executive Summary

into the United States of America. Seward has already begun their celebratory events with other KPB communities in planning stages of their activities.

ConocoPhillips still waits for federal approval of their application for a two year extension to their liquid natural gas export license which will expire during 2009 unless the extension is approved. Following negotiations, the State of Alaska is supporting the extension after ConocoPhillips agreed to several conditions for that support, including possible purchase of natural gas from other suppliers, development of additional gas reserves in Cook Inlet, and continuation of provision of natural gas in the event of local area gas shortages that may occur due to extended cold spells. All now wait for a decision at the federal level.

Agrium has determined that a proposed coal gasification plant is not economically feasible. Northern Dynasty continues to research the copper, gold and molybdenum deposit known as Pebble Mine. Construction of a natural gas pipeline from the North Slope continues to be discussed at various levels as only one company, headquartered in Canada, has met AGIA standards. ConocoPhillips has proposed a plan that does not meet AGIA standards, but one which it feels would more likely be a successful project due to taxation stability. ANGDA is considering development of a bullet line to supply gas to Alaskan residents, a pipeline that would have a smaller diameter, reducing cost, but also reducing the volume of gas that could be transported on a daily basis.

SALES

Sales data presented in this publication is accurate as of February 11, 2007. In order to avoid presentation of proprietary data, a change has been made in the number of lines of business (LOB) for which sales are noted. Sales are categorized according to NAICS LOB's selected by each establishment as license applications were completed.

A change in sales reporting requirements became effective as of April 2004 that allows businesses with less than \$6,000 in annual taxable sales, and meeting other reporting requirements, to prepare an annual report on the fourth quarter reporting timeline, thereby reporting on an annual rather than a quarterly basis. This skews quarterly gross sales data as fewer sales are reported during first, second and third quarter, but increased sales are reported during fourth quarter when annual sales reports are due. Additional reporting requirements have also been implemented which require businesses to report nontaxable sales and to indicate which exemption allows the exclusions. These changes may cause apparent sales increases when compared to prior periods; however, increases may be due to more complete, and therefore more accurate, reporting.

Executive Summary

Quarterly Sales

KPB gross sales decreased 7.3% to \$858,142,418 for the quarter, \$67,588,727 less than fourth quarter 2006 gross sales. Six of twelve LOB's marked gains, the other six marked decreased sales. Taxable sales grew by 2.8% to reach \$194,896,650, surpassing 2006 fourth quarter sales by \$5,391,051 as eight of the twelve LOB's experienced increased sales.

Gross by Line of Business. As six LOB's increased quarterly sales, the largest percentage gain, 10.8%, came as resource production increased from \$73,192,527 to \$81,092,098, gaining \$7,899,571. Transportation & warehousing gained 10.4% or \$4,245,305 to reach \$44,974,591. Both wholesale sales and services gained over 8% with sales of \$329,658,837, up \$24,593,859, and \$44,181,379, up \$3,401,278, respectively, when comparing fourth quarters of 2006 with 2007. Other LOB's with increased sales include retail sales that were up 6.5% to total \$160,715,101, and manufacturing sales that gained 4.5% to reach \$36,156,921.

After strong construction sales over the last three years, sales declined 61.1% or \$106,585,592 to \$67,785,218. Sale of professional services declined \$4,255,934 or 18.3% to \$18,985,195. Rentals and tourism sales each decreased by over \$2 million with sales of \$21,986,899 and \$17,101,518, respectively. Utility sales were down 5.3% to \$36,156,921 while government sales decreased by 45.6% to \$2,262,767. (See page 15 for detail.)

Taxable by Line of Business. Eight of twelve LOB's experienced increased sales when comparing fourth quarter 2006 and 2007 while KPB total taxable sales increased 2.8% to \$194,896,650 over fourth quarter 2006 sales of \$189,505,599. Retail sales had the largest monetary gain, \$6,674,790, to reach \$101,640,962, gaining 7.0%. Sale of wholesale goods increased 7.6%, or \$1,430,047, to \$20,168,464 while service sales increased by \$1,031,649 or 4.9% to \$22,066,117. Transportation & warehousing gained 19.3% with \$1,491,682 in sales. Other LOB's with increasing sales include resource production, up 13.1%; construction sales, up 6.0%; rentals, up 5.3%; services, up 4.9%; and professional service sales that were 2.1% above fourth quarter 2006 sales.

Four LOB's experienced declining quarterly sales when compared to 2006. Tourism sales dropped 12.2% or \$2,174,261 to \$15,675,516, down from \$17,849,777 a year ago. Government sales, which now include native groups, were down 49.1% or \$1,614,210 to \$1,676,692. Utility sales, which had a large increase a year ago, were down 4.6% or \$689,367 to \$14,397,718. Lastly, sale of manufactured goods decreased to \$1,316,736 from \$1,664,444, a 20.9% drop, a decrease of \$347,708 in sales. (See page 16 for detail.)

Executive Summary

Gross by Area. With KPB sales down 7.3%, only Seldovia and the Other KPB areas experienced increasing gross sales when comparing fourth quarter 2006 and 2007. Seldovia sales reached \$3,197,313, an increase of 136.0% or \$1,842,443. Sales outside the cities gained 1.6% to reach \$487,471,117, gaining \$7,586,661 over the 2006 total, \$479,884,456.

Kenai sales had the smallest decrease, 4.9%, down \$8,020,553 to \$154,344,262. Homer sales totaled \$76,234,220, down 17.4% or \$16,006,712 from fourth quarter sales of \$92,240,932 of 2006. With sales of \$106,496,374, Soldotna sales were down 23.9% from \$139,953,787 one year ago. Lastly, Seward sales of \$30,399,133 were 39.1% less than a year ago when sales totaled \$49,932,284. This decrease of \$19,533,151 is not surprising as 2006 fourth quarter sales were exceptionally high. (See detail on page 17.)

Taxable by Area. KPB fourth quarter 2007 taxable sales were 2.8% greater than fourth quarter of 2006 with five of six areas experiencing increased sales. With the largest percentage gain, 10.0%, Seldovia sales gained \$70,819 for a total of \$779,879. Kenai followed with a 6.2% increase and sales of \$39,715,404. This is \$2,301,593 greater than sales of \$37,413,811 during the same quarter of 2006. Soldotna sales were 5.1% above 2006 with sales totaling \$56,913,223, gaining \$2,740,483 over sales of \$54,172,740 one year ago. Homer sales grew by 0.03% to reach \$30,408,885, just \$9,802 more than the fourth quarter 2006 total of \$30,399,083. (See detail on page 18.)

Seward, the only city with decreased taxable sales, saw a 12.4% decrease from \$11,846,257 to \$10,374,314, a \$1,471,943 decrease.

Annual Sales

KPB 2007 gross sales increased 2.3% to \$2,762,730,576 from the 2006 total of \$2,701,347,858, gaining \$61,382,718. This follows 5.3% growth during 2006 and 9.9% during 2005.

Taxable sales increased 8.5% from 2006 to 2007 with sales reaching \$962,990,163, following a 7.5% increase from 2005 to the 2006 level of \$887,619,393, and a 5.7% gain from 2004 to 2005.

Gross by Line of Business. Eight of twelve LOB's experienced increased sales when comparing 2007 to 2006 with five LOB's having gains greater than \$30 million. Transportation & warehousing sales increased by 21.6% to reach \$214,474,327. This is a gain of \$38,040,662 over the \$214,474,327 in sales a year ago. Service sales also increased 21.6% as sales reached \$191,799,629. This is \$34,023,484 greater than \$157,776,145 in 2006 sales. Manufacturing sales increased \$34,006,084, a 19.2% gain over \$177,301,795, to total \$211,307,879. Retail sales of \$686,530,209 were

Executive Summary

\$34,469,810 or 5.3% greater than those of 2006 when sales reached \$652,060,399. Sale of wholesale goods increased 6.1% or \$30,416,099 to \$529,512,444, up from \$499,096,345 during 2006. With lesser numerical gains, utility sales increased by \$4,475,966 to reach \$125,492,246; tourism sales were up \$2,163,822 to \$163,664,654; and rental sales increased \$343,289 to \$89,892,272.

Construction sales have been strong the last several years but during 2007 sales of \$280,808,993 were \$81,646,008 less than those of 2006. This is 22.5% less than 2006 sales of \$362,455,001. Resource production sales dropped by 14.6% or \$32,424,180 from \$221,387,274 to \$188,963,094. Sale of professional services were down \$1,299,793 to \$65,785,646 while government sales were down \$1,186,517 to \$14,499,183. (See detail on page 19.)

Taxable by Line of Business. Taxable sales during 2007 were 8.5% greater than those of 2006 as government was the only LOB with decreasing sales. Total taxable sales of \$962,990,163 were \$75,370,770 more than during 2006 when total KPB sales were \$887,619,393.

Retail sales grew 8.2% or \$34,010,912 to total \$447,462,961. Transportation & warehousing sales rose 45.9% or \$11,838,132 to \$37,640,268 while service sales of \$95,821,995 were \$10,101,289 greater than during 2006, marking an 11.8% increase. Utility sales gained 15.7% to reach \$57,608,289 while resource production sales grew by 14.2% to \$6,294,070. Both property rentals and tourism sales increased approximately \$3.5 million. Property rentals increased 10.2% to \$37,128,954 while tourism sales gained 2.4% to \$149,466,513. Although construction gross sales dropped significantly from 2006 to 2007, taxable sales increased by 7.9% to \$12,094,817. Sale of professional services increased 4.9% to \$15,441,630, manufacturing sales grew by 3.9% to \$9,838,378, and sale of wholesale goods grew 3.8% to \$81,865,128. (Detail on page 20.)

Government sales was the only decreasing LOB, as sales were down 8.2% or \$1,106,379 to \$12,327,160.

Gross by Area. KPB gross sales increased in six areas as annual gross sales gained 2.3% to \$2,762,730,576. Kenai gross sales increased by \$57,475,719 to reach \$513,792,001, a 12.6% gain. Growth in transportation & warehousing along with increasing sale of wholesale goods led to Kenai's growth. Sales outside KPB cities reached \$1,281,491,850, gaining 2.5% or \$31,466,673. Strong sales in manufacturing, wholesale goods, services, retail sales and utilities overcame decreasing sales in resource production. Seldovia 2007 sales were 23.0% greater than those of 2006 and totaled \$9,303,996, up \$1,741,353, with strength in construction sales.

With declining sales, Seward sales were down 3.6% to \$191,373,024, dropping by \$7,192,259. Soldotna saw sales decrease 3.4%, or \$14,543,331, to \$418,070,734. Homer sales decreased 2.1% to \$348,698,971, down \$7,565,437. Construction sales

Executive Summary

accounted for the major portion of declining sales in each of the three cities. (See detail on page 21.)

Taxable by Area. Taxable sales increased in each reporting area when comparing 2007 sales with those of 2006 as annual sales increased 8.5% to \$962,990,163. The greatest percentage growth came in Seldovia, 16.5%, where sales reached \$4,271,802, gaining \$604,745 over the 2006 total of \$3,667,057. The Other KPB region saw sales increase 12.4%, or \$31,705,032, to \$288,225,171. The 2006 total was \$256,520,139. With sales gaining 10.4%, Seward sales reached \$100,489,096. This is \$9,462,486 greater than 2006 sales of \$91,026,610. Homer sales of \$164,285,716 were 7.2% above 2006 and were \$10,983,826 greater than the previous total, \$153,301,890. With 6.4% growth, Soldotna sales reached \$241,773,296, gaining \$14,488,513 over 2006 sales of \$227,284,783. While Kenai had the largest percentage gain in gross sales, taxable sales had the smallest annual gain, 5.2%. Sales of \$163,945,082 were \$8,126,168 greater than 2006 taxable sales of \$155,818,914. (See detail on page 22.)

CONSTRUCTION ACTIVITY

Quarterly Permitting

Construction permit values set a new record high, growing from \$6,938,082 one year ago to \$22,494,245 during fourth quarter of 2007. Total quarterly value is the highest fourth quarter on record as Seward permitted construction of a new Long Term Care Facility. Fourth quarter 2007 volume is third highest fourth quarter activity on record with 56 permits issued compared to 33 during fourth quarter 2006.

By Area, Value. Seward issued construction permits with a total value of \$18,139,500 during the quarter, 80.6% of the KPB total, issuing a permit for a new Long Term Care Facility and increasing from \$1,944,300 in permit value a year ago. Soldotna issued permits with a total value of \$2,292,045, up from \$632,882 during fourth quarter 2006. Homer's total, \$1,622,000, was down from \$2,555,000 while Kenai permit values totaled \$439,700, down from \$1,787,900. Seldovia added \$1,000, down from \$18,000. (See detail on page 28.)

By Area, Volume. Soldotna fourth quarter permitting increased from 7 permits to 16, while Homer grew from 5 permits a year ago to 16 during fourth quarter 2007. Kenai was stable at fourteen permits each of the past two years. Seward grew from six to nine permits while Seldovia issued one permit each of the last two fourth quarters. (See detail on page 28.)

By Type, Value. Fourth quarter total permit value of \$22,494,245 saw new commercial construction projects accounting for 88.7% of the total, \$19,955,112. Each of the other

Executive Summary

categories provided less than one million dollars toward the quarterly total. New residential permits provided \$933,000, followed by residential alteration permitting with a total value of \$876,365. Commercial alteration projects added the remaining \$729,768. (See detail on page 29.)

By Type, Volume. Fifty-six permits were issued during the quarter, increasing from 33 a year ago. Twenty-six permits were for residential alteration/additions, up from nine during fourth quarter 2006. Fifteen were issued for commercial alteration/additions, six more than fourth quarter 2006. Eight new commercial permits were issued, up from seven during 2006 fourth quarter. Seven new residential projects were approved, down from eight a year ago. (See detail on page 29.)

Annual Permitting

Construction permit values during 2004 totaled \$84,041,457, exceeding the previous high of 1995 when total value reached \$61,670,382. Activity during 2005 dropped to \$44,733,803, but 2006 nearly reached the 2004 level as \$80,230,660 in permit value was issued. The 2007 total, \$71,666,849, was less than 2006 but showed strength as it ranked third highest on record. Permits are required for projects within KPB cities but the KPB does not require building permits.

The 334 construction permits issued marked the fourth highest total behind 351 issued during 2002. The 2005 total volume was 338 permits, down from 2003 with 336 permits, second and third highest on record. There were 323 permits issued during 2006, eleven less than during 2007.

By Area, Value. KPB's 2007 total permitted value reached \$71,666,849, a 10.7% decrease from the 2006 total of \$80,230,660. Kenai, with a 2007 total permit value of \$22,398,000, accounted for 31.3% of KPB's annual total, and gained 102.2% over the city's 2006 total of \$11,076,154. Both new commercial permitting and commercial alteration/additions in Kenai passed the \$7 million mark while housing values totaled \$5.7 million. Seldovia saw a 154.7% gain to \$343,800 from \$135,000 during 2006 with strength in new residential permitting.

Seward's total, \$21,095,925 and 29.4% of the KPB total, was down 17.4% from 2006 with a total of \$25,537,249. Seward new commercial construction value of \$18 million included permitting of a Long Term Care facility. Homer added \$14,066,201, dropping 30.7% from the 2006 total, \$20,287,857. Soldotna followed with \$13,762,923, down 40.7% from a year earlier. Seward's strength came in new commercial permitting while Homer and Soldotna saw strong new residential permitting. (See detail on page 30.)

By Area, Volume. With 334 building permits issued for the year, 112 were issued in Kenai, 33.5% of the KPB total, one less permit than during 2006. Homer issued 87 permits, four more than a year ago, providing 26.0% of the KPB total. Soldotna added

Executive Summary

80 permits for 24.0%, up from 64 permits issued during 2006. Seward's 37 permits were 18 fewer than the 55 permits issued last year, and 11.1% of the KPB total. Lastly, Seldovia issued eighteen permits, up from eight issued during 2006, 5.4% of the KPB total. (See detail on page 30.)

By Type, Value. New commercial permitting provided 47.4% of 2007 annual permit value with \$33,961,168 of the \$71,666,849 KPB total. New commercial permitting was 22.8% less than 2006. New residential projects added \$22,612,367, down 13.9% from \$26,277,740 issued a year earlier. Commercial alteration/additions added \$10,986,874, up 39.4% from 2006, while residential alteration/addition activity added \$4,106,440, up 98.4% from a year earlier. (See detail on page 31.)

By Type, Volume. Construction permit volume gained 3.4% during 2007, with decreased activity in both new commercial and new residential activity. Residential alteration/addition permits increased from 86 to 119 for the year, a 38.4% increase over 2006. Sixty-eight permits were issued for commercial alteration/addition projects, identical to one year ago. There were 110 new homes permitted within KPB cities, down from 126 during 2006. Lastly, 37 new commercial permits were issued, down from 43 during 2006. (See detail on page 31.)

UNEMPLOYMENT

Monthly unemployment data are received from the AK DOL. Data are developed from a survey of residents across the region with survey results input into a nationwide model. The detail is not an actual count, but rather an estimate based upon survey responses and calculations used in the standardized model.

The October 2007 estimate of KPB's labor force was 24,564 persons, down 177 from 24,741 during October 2006. The November total of 24,678 was up from 24,605 a year ago. The December total, 24,760, was slightly less than the 24,773 of December 2006. The fourth quarter average labor force - 24,667 - was 106 persons less than the 2006 fourth quarter average. On an annual basis, the 2006 average labor force was 25,418 while during 2007 it was 25,529, a gain of 111 potential workers.

October 2007 saw 1,650 unemployed KPB residents, down from 1,740 one year ago. November unemployment increased to 1,988, a gain of two from a year earlier. The December 2007 count also increased, to 2,203, but remained less than the 2006 estimate, 2,256. The 2007 fourth quarter average unemployment, 1,947, was 47 persons less than fourth quarter 2006 when 1,994 persons were unemployed.

KPB's October 2007 unemployment rate of 6.7% was down from 7.0% during October 2006. The rate increased to 8.1% during November, identical to the November 2006 rate. It continued the annual upward trend during December to 8.9% but remained

Executive Summary

below the December 2006 rate of 9.1%. The fourth quarter average unemployment rate during 2007 was 7.9%, compared to an 8.1% average for the same period of 2006. For the year, the 2007 average rate was 7.8%, while the 2006 annual average was 8.3%.

October 2007 employment was estimated at 22,914, down from 23,001 during 2006. November employment increased to 22,690 from 22,619 a year earlier, gaining 71 persons. December saw employment at 22,557, up from 22,517 during 2006. The quarterly average employment increased by 8 workers from 22,712 during 2006 to 22,720 for fourth quarter 2007. The 2006 annual average monthly employment was estimated at 23,317. With a larger labor force and lower unemployment, the 2007 employment figure stood at 23,563, a gain of 245 persons employed. (See detail on pages 37 and 38.)

POPULATION

Population estimates for 2006 show the KPB population at 51,350 persons, a 0.2% increase for the year. Since Census 2000, KPB's natural increase (births minus deaths) has resulted in a gain of 1,659 persons, and in the past year, the natural increase added 82 persons. Other changes are due to in or out migration.

CDP's and cities with the greatest estimated change from 2005 to 2006 include Kalifornsky, with a gain of 166 persons and Kenai gaining 87. Bear Creek added 38 and Anchor Point grew by 36 persons. With decreasing population, Ridgeway saw a loss of 101 persons. Seldovia's population decreased by 67 persons while Soldotna was down 62. Fritz Creek was down 52 persons while Diamond Ridge lost 42 residents.

Since 2005 estimates, Homer gained 0.3% to 5,454 persons while Kachemak City gained 0.2% to a total of 458 persons. Kenai gained 1.3% to 6,864 residents. Seldovia City decreased 23.3% to 220 and Seward gained 0.8%, to 2,627 persons. Soldotna's population decreased 1.6% to 3,807. Alaska's 2006 population, estimated at 670,053, increased 0.1% from 663,253 during 2005. (See page 39 for detail.)

The 2006 median age is estimated at 33.5 years for Alaska and 39.7 years for the KPB. Comparing KPB with Alaska's largest boroughs, KPB has the oldest population. Juneau follows with a median age of 38.8 years. The Matanuska-Susitna Borough follows with an average age of 34.9 years while the Municipality of Anchorage stands at 32.4 years. Fairbanks has the youngest median age of Alaska's largest boroughs at 31.2 years.

KPB Sales

KPB sales information includes detail from Homer, Kenai, Seldovia, Seward, Soldotna and "Other" - which indicates KPB regions outside boundaries of the five incorporated cities. It also includes Kachemak City, which does not impose a sales tax. The 3% KPB sales tax is included in the city rates listed below. The balance is imposed by each city. KPB sales tax assessments increased from 2% to 3%, effective January 1, 2008. Proceeds will continue to be dedicated to the KPB school district.

Sales are reported by Line of Business (LOB) based upon the LOB listed on each establishment's business license, effective with this publication. This change is due to confusion between NAICS and LOB classification systems, and will provide consistent and timely reporting.

Sales data presented is accurate as of February 11, 2008

7.5%	7.0%	6.0%	5.0%	3.0%
Homer	Seward	Kenai	Seldovia	Other
Seldovia (April - September)		Soldotna	(October - March)	

Table 1.1

Gross and taxable sales data are received quarterly through Sales Tax Returns from KPB businesses. Exempt sales include the following:

- | | |
|-------------------------------|----------------------------------------|
| Sales outside the borough; | Sales to tax exempt organizations; and |
| Sales for resale; | Sales in excess of \$500. |
| Sales to government agencies; | |

Due to concerns of releasing proprietary information, similar LOB's have been grouped into categories.

LOB abbreviations and LOB's included in each are listed below.

RSRC	Resource Production	Agriculture, Forestry, Fishing and Hunting Mining - (Includes oil and gas exploration, Resource Production, gravel) Timbering
MFG	Manufacturing	Manufacturing - (Includes oil and gas manufacturing, fish processing)
CONST	Construction	Construction
SALES	Sales	Restaurant, Bar Retail
PROP	Rentals	Rental Commercial Property Rental Residential Property Rental Personal Property Rental Non-residential Properties Trailer Court
TOUR	Tourism	Arts, Entertainment, Recreation Guiding Land Guiding Water Accommodation, Food Services
SERV	Services	Administration, Support, Waste Management, Remediation Educational Services Finance and Insurance Information Other Services Remediation Services Telecommunications
PROF	Professional	Health and Social Services Management of Companies, Enterprises Professional, Scientific, Technical
UTIL	Utilities	Utilities
TRAN	Transport/ Warehouse	Transportation and Warehousing
WHSL	Wholesale	Wholesale
GOV	Public Administration	Public Administration - (Includes Native Organizations)

Table 1.2

KPB Sales

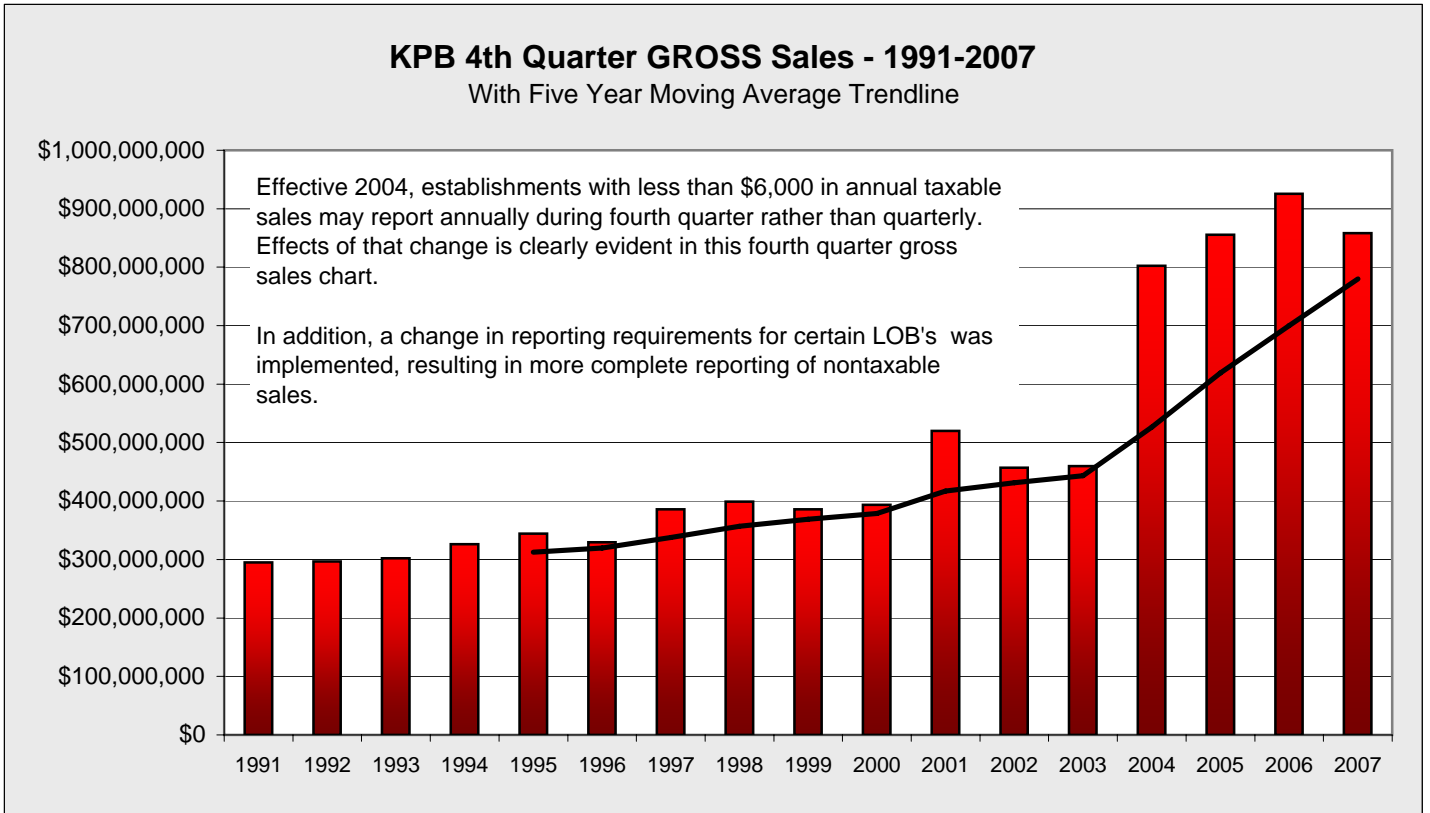

Chart 1.1

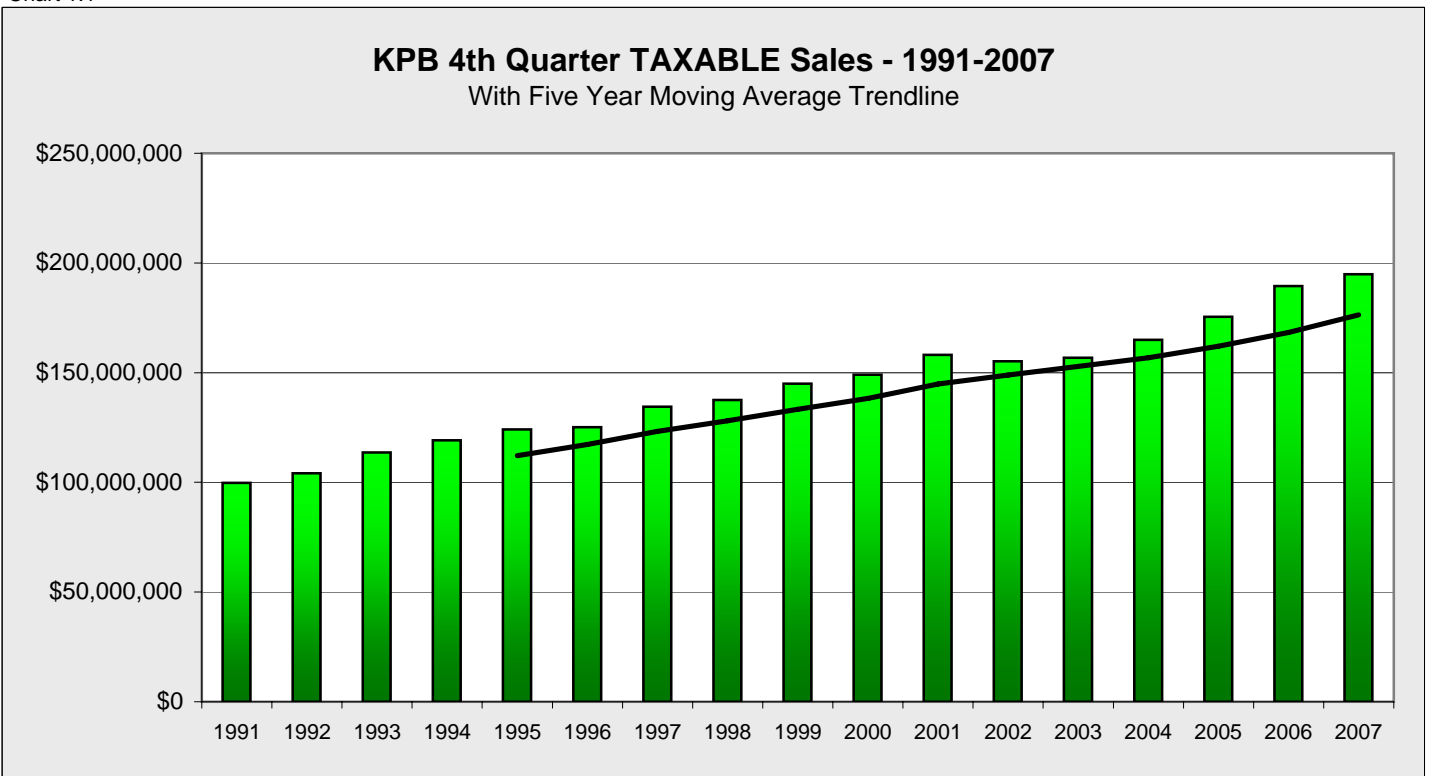

Chart 1.2

KPB Sales

KPB 4th Quarter GROSS Sales by Line of Business - 2002-2007 - in \$*

LOB	2002	2003	2004	2005	2006	2007	Annual Percent Change	Annual Amount Change
RSRC	83,966,913	57,304,082	148,051,876	122,190,206	73,192,527	81,092,098	10.8%	7,899,571
SALES	150,389,621	133,713,638	139,436,960	139,250,296	150,908,209	160,715,101	6.5%	9,806,892
CONST	59,151,688	61,306,115	95,902,592	111,048,336	174,370,810	67,785,218	-61.1%	-106,585,592
PROP	17,201,193	22,122,088	23,320,188	23,665,316	24,079,310	21,986,899	-8.7%	-2,092,411
TOUR	16,850,446	17,246,370	17,701,354	18,011,781	19,508,879	17,101,518	-12.3%	-2,407,361
SERV	26,364,595	26,629,763	41,607,086	35,864,223	40,780,101	44,181,379	8.3%	3,401,278
PROF	13,641,294	13,054,595	20,815,253	21,643,226	23,241,129	18,985,195	-18.3%	-4,255,934
UTIL	21,052,679	20,367,042	22,946,239	26,579,805	35,102,472	33,241,924	-5.3%	-1,860,548
MFG	17,546,027	34,629,796	33,856,320	42,020,585	34,596,361	36,156,921	4.5%	1,560,560
TRAN	6,872,136	8,336,441	14,550,650	41,143,504	40,729,256	44,974,561	10.4%	4,245,305
WHSL	40,954,584	61,122,592	239,906,785	269,933,998	305,064,978	329,658,837	8.1%	24,593,859
GOV	3,207,508	3,814,224	4,218,909	3,925,279	4,157,113	2,262,767	-45.6%	-1,894,346
TOTAL	457,198,684	459,646,746	802,314,212	855,276,555	925,731,145	858,142,418	-7.3%	-67,588,727
Annual Change		0.5%	74.6%	6.6%	8.2%	-7.3%		

Table 1.3

* - For complete Line of Business (LOB) listing, see page 13.

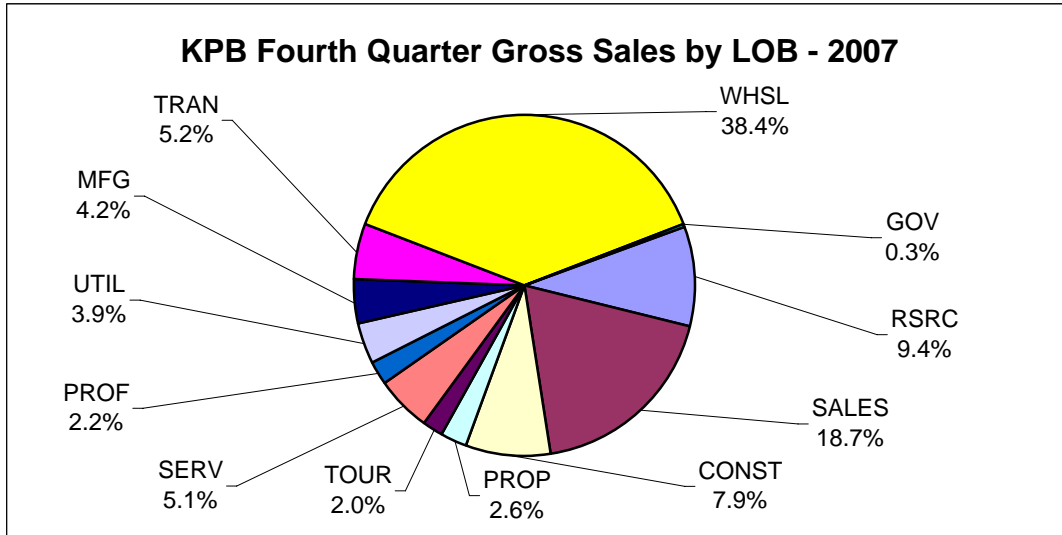

Chart 1.3

Gross Sales Five Year Change by Line of Business

LOB	2002	2007	Value Change	Percent Change
RSRC	83,966,913	81,092,098	-2,874,815	-3.4%
SALES	150,389,621	160,715,101	10,325,480	6.9%
CONST	59,151,688	67,785,218	8,633,530	14.6%
PROP	17,201,193	21,986,899	4,785,706	27.8%
TOUR	16,850,446	17,101,518	251,072	1.5%
SERV	26,364,595	44,181,379	17,816,784	67.6%
PROF	13,641,294	18,985,195	5,343,901	39.2%
UTIL	21,052,679	33,241,924	12,189,245	57.9%
MFG	17,546,027	36,156,921	18,610,894	106.1%
TRAN	6,872,136	44,974,561	38,102,425	554.4%
WHSL	40,954,584	329,658,837	288,704,253	704.9%
GOV	3,207,508	2,262,767	-944,741	-29.5%

Table 1.4

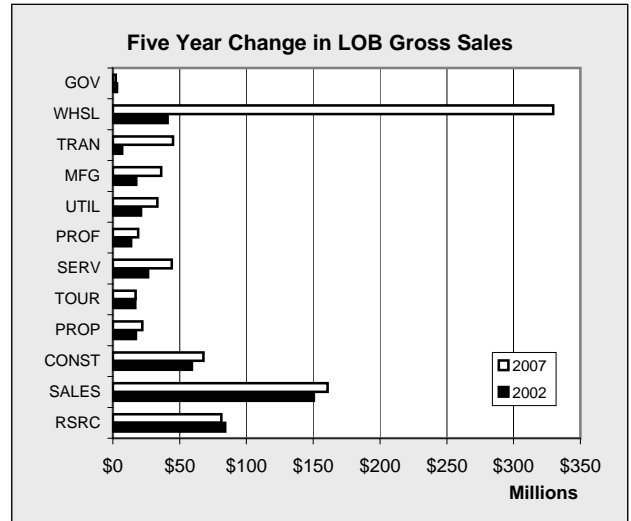

Chart 1.4

KPB Sales

KPB 4th Quarter TAXABLE Sales by Line of Business - 2002-2007 - in \$*								
LOB	2002	2003	2004	2005	2006	2007	Annual Percent Change	Annual Amount Change
RSRC	1,455,910	1,188,501	1,382,972	1,209,760	1,239,689	1,402,252	13.1%	162,563
SALES	84,888,997	84,529,720	84,659,273	88,920,396	94,966,172	101,640,962	7.0%	6,674,790
CONST	2,827,627	2,851,514	2,684,449	2,685,333	2,986,004	3,164,631	6.0%	178,627
PROP	7,529,817	7,080,489	7,365,935	7,588,590	8,144,390	8,572,733	5.3%	428,343
TOUR	15,623,313	15,995,377	16,144,641	16,730,636	17,849,777	15,675,516	-12.2%	-2,174,261
SERV	17,813,914	17,529,230	18,788,035	19,424,105	21,034,468	22,066,117	4.9%	1,031,649
PROF	3,091,493	2,931,724	3,022,875	3,043,975	3,254,240	3,323,147	2.1%	68,907
UTIL	8,841,956	9,122,766	9,802,497	11,116,084	15,087,085	14,397,718	-4.6%	-689,367
MFG	1,111,480	1,122,029	1,119,896	1,787,357	1,664,444	1,316,736	-20.9%	-347,708
TRAN	1,194,250	1,182,638	1,143,558	1,583,884	1,250,011	1,491,682	19.3%	241,671
WHSL	8,142,737	10,412,314	16,001,318	18,330,609	18,738,417	20,168,464	7.6%	1,430,047
GOV	2,646,461	2,803,462	2,879,524	3,094,913	3,290,902	1,676,692	-49.1%	-1,614,210
TOTAL	155,167,955	156,749,764	164,994,973	175,515,642	189,505,599	194,896,650	2.8%	5,391,051
Annual Change		1.0%	5.3%	6.4%	8.0%	2.8%		

Table 1.5

* - For complete Line of Business (LOB) listing, see page 13.

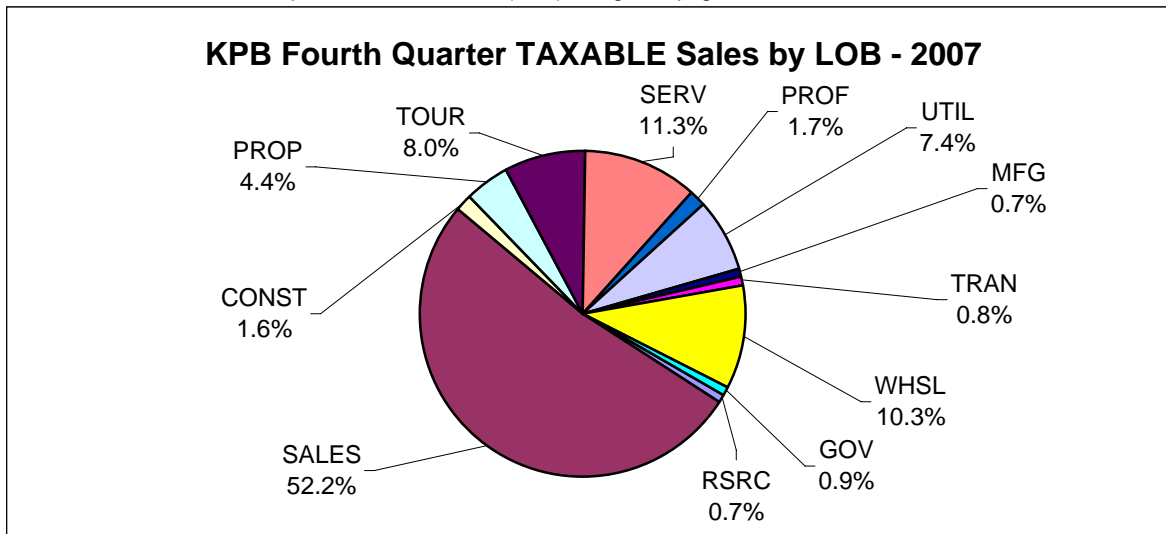

Chart 1.5

TAXABLE Sales Five Year Change by Line of Business				
LOB	2002	2007	Value Change	Percent Change
RSRC	1,455,910	1,402,252	-53,658	-3.7%
SALES	84,888,997	101,640,962	16,751,965	19.7%
CONST	2,827,627	3,164,631	337,004	11.9%
PROP	7,529,817	8,572,733	1,042,916	13.9%
TOUR	15,623,313	15,675,516	52,203	0.3%
SERV	17,813,914	22,066,117	4,252,203	23.9%
PROF	3,091,493	3,323,147	231,654	7.5%
UTIL	8,841,956	14,397,718	5,555,762	62.8%
MFG	1,111,480	1,316,736	205,256	18.5%
TRAN	1,194,250	1,491,682	297,432	24.9%
WHSL	8,142,737	20,168,464	12,025,727	147.7%
GOV	2,646,461	1,676,692	-969,769	-36.6%

Table 1.6

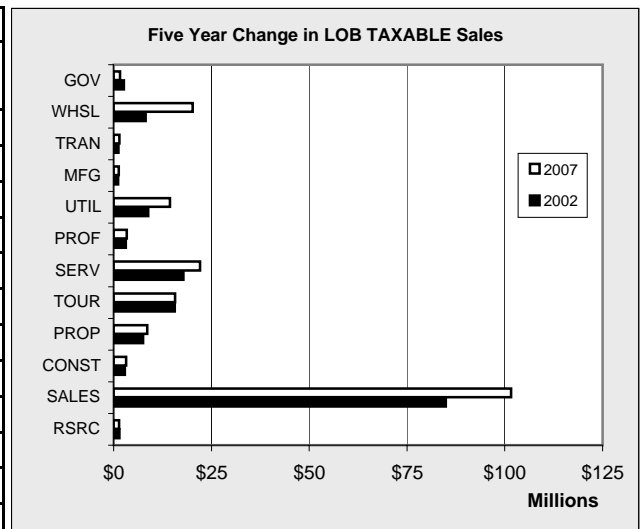

Chart 1.6

KPB Sales

KPB 4th Quarter GROSS Sales by Area - 2002-2007 - in \$

	2002	2003	2004	2005	2006	2007	Annual Percent Change	Annual Amount Change
Homer	60,586,992	60,330,717	72,595,789	70,599,184	92,240,932	76,234,220	-17.4%	-16,006,712
Kenai	68,530,671	72,498,893	167,965,637	175,237,181	162,364,815	154,344,262	-4.9%	-8,020,553
Seldovia	956,936	1,949,309	3,144,047	1,212,472	1,354,870	3,197,313	136.0%	1,842,443
Seward	22,308,588	27,334,414	38,360,976	34,221,900	49,932,284	30,399,133	-39.1%	-19,533,151
Soldotna	80,180,782	82,155,118	94,820,763	128,499,671	139,953,787	106,496,374	-23.9%	-33,457,413
Other	224,634,715	215,378,295	425,427,000	445,506,147	479,884,456	487,471,117	1.6%	7,586,661
Total	457,198,684	459,646,746	802,314,212	855,276,555	925,731,144	858,142,419	-7.3%	-67,588,725
Annual Change		0.5%	74.6%	6.6%	8.2%	-7.3%		

Table 1.7

KPB 4th Quarter GROSS Sales by Area - 2002-2007

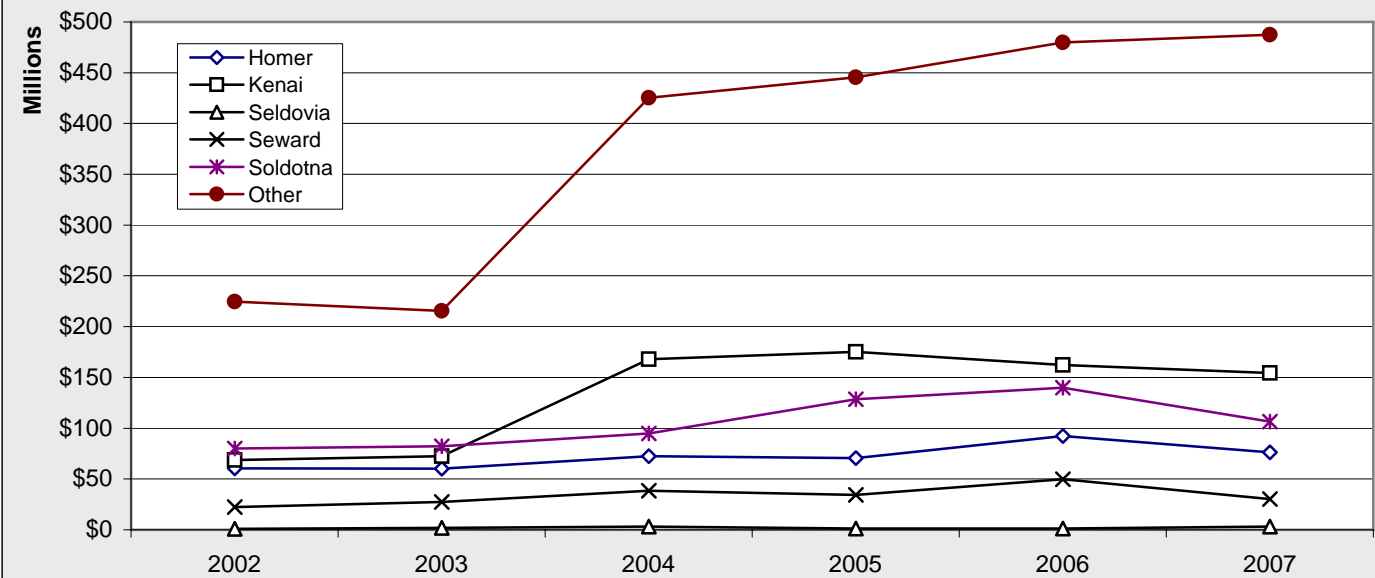

Chart 1.7

Gross Sales Five Year Change by Line of Business

	2002	2007	Value Change	Percent Change
Homer	60,586,992	76,234,220	15,647,228	25.8%
Kenai	68,530,671	154,344,262	85,813,591	125.2%
Seldovia	956,936	3,197,313	2,240,377	234.1%
Seward	22,308,588	30,399,133	8,090,545	36.3%
Soldotna	80,180,782	106,496,374	26,315,592	32.8%
Other	224,634,715	487,471,117	262,836,402	117.0%

Table 1.8

KPB 4th Quarter Gross Sales by Area 2007

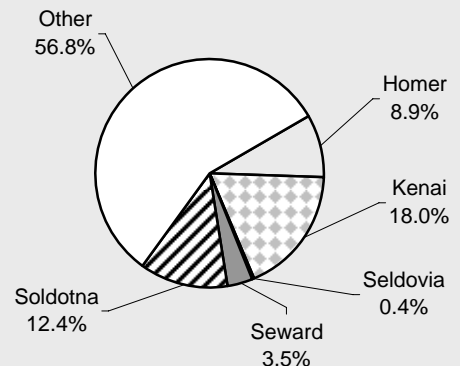

Chart 1.8

KPB Sales

KPB 4th Quarter TAXABLE Sales by Area - 2002-2007 - in \$								
	2002	2003	2004	2005	2006	2007	Annual Percent Change	Annual Amount Change
Homer	25,063,470	27,107,360	27,490,906	28,688,087	30,399,083	30,408,885	0.03%	9,802
Kenai	34,974,885	29,078,527	33,535,807	35,634,926	37,413,811	39,715,404	6.2%	2,301,593
Seldovia	607,946	674,689	697,859	660,146	709,060	779,879	10.0%	70,819
Seward	10,025,144	10,289,302	10,386,426	11,427,213	11,846,257	10,374,314	-12.4%	-1,471,943
Soldotna	42,248,703	46,558,340	47,479,294	50,403,476	54,172,740	56,913,223	5.1%	2,740,483
Other	42,247,807	43,041,546	45,404,681	48,701,794	54,964,648	56,704,945	3.2%	1,740,297
Total	155,167,955	156,749,764	164,994,973	175,515,642	189,505,599	194,896,650	2.8%	5,391,051
Annual Change		1.0%	5.3%	6.4%	8.0%	2.8%		

Table 1.9

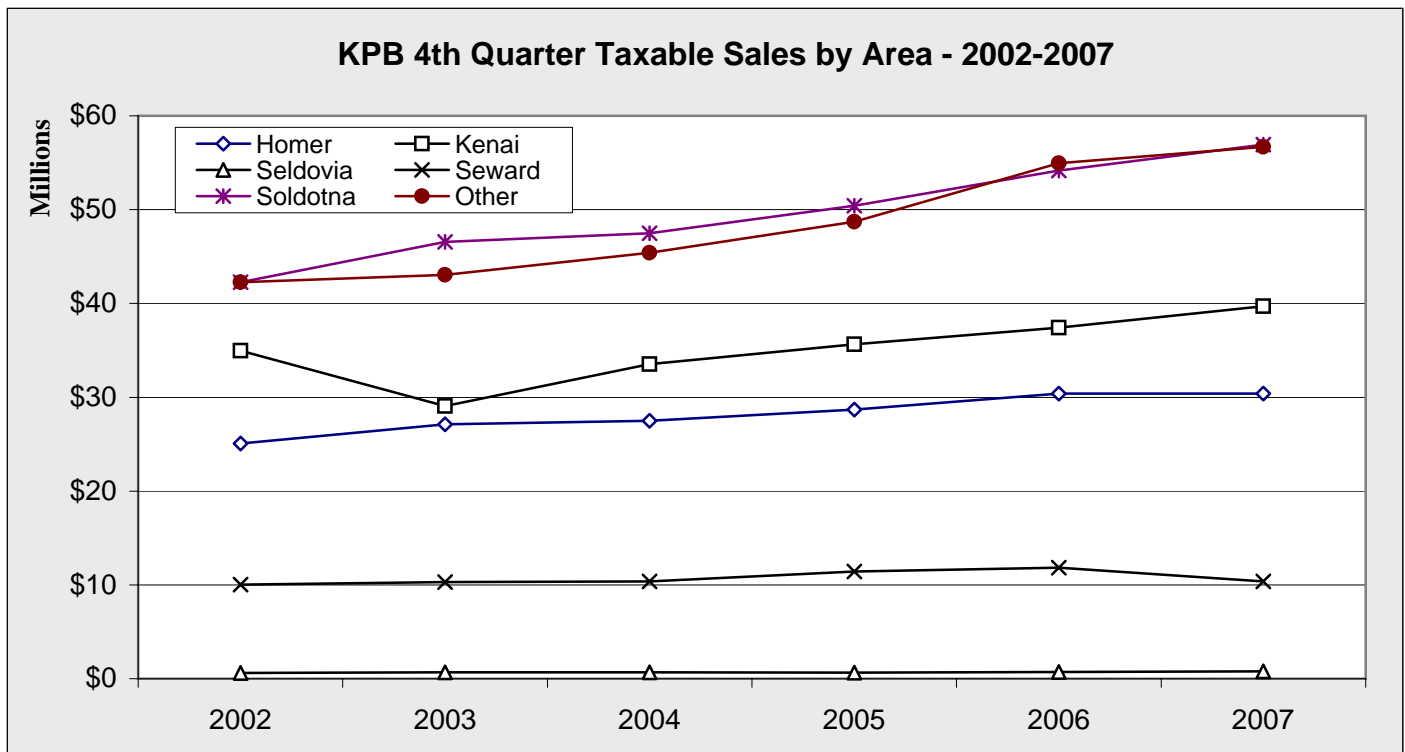

Chart 1.9

Taxable Sales Five Year Change by Line of Business				
	2002	2007	Value Change	Percent Change
Homer	25,063,470	30,408,885	5,345,415	21.3%
Kenai	34,974,885	39,715,404	4,740,519	13.6%
Seldovia	607,946	779,879	171,933	28.3%
Seward	10,025,144	10,374,314	349,170	3.5%
Soldotna	42,248,703	56,913,223	14,664,520	34.7%
Other	42,247,807	56,704,945	14,457,138	34.2%

Table 1.10

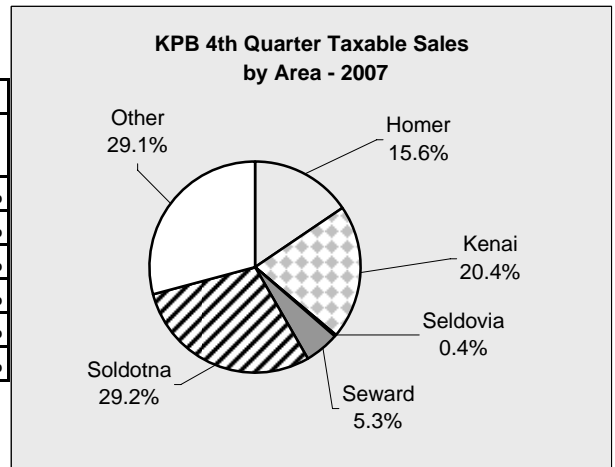

Chart 1.10

KPB Sales

KPB Annual GROSS Sales by Line of Business - 2002-2007 - in \$

LOB	2002	2003	2004	2005	2006	2007	Annual Percent Change	Annual Amount Change
RSRC	176,421,465	182,434,266	250,770,234	236,299,925	221,387,274	188,963,094	-14.6%	-32,424,180
SALES	628,472,013	611,324,051	588,239,882	609,460,992	652,060,399	686,530,209	5.3%	34,469,810
CONST	212,755,561	239,118,564	222,665,293	290,081,253	362,455,001	280,808,993	-22.5%	-81,646,008
PROP	76,051,683	81,109,127	80,240,612	82,576,477	89,548,983	89,892,272	0.4%	343,289
TOUR	118,402,713	119,445,790	129,888,280	135,873,034	161,500,832	163,664,654	1.3%	2,163,822
SERV	121,513,322	115,631,552	137,231,314	139,075,664	157,776,145	191,799,629	21.6%	34,023,484
PROF	48,946,237	53,795,685	59,110,980	59,410,340	67,085,439	65,785,646	-1.9%	-1,299,793
UTIL	90,874,237	79,515,989	87,509,276	103,471,296	121,016,280	125,492,246	3.7%	4,475,966
MFG	138,105,065	140,566,505	179,632,875	248,498,352	177,301,795	211,307,879	19.2%	34,006,084
TRAN	88,245,139	79,449,807	122,937,678	178,141,007	176,433,665	214,474,327	21.6%	38,040,662
WHSL	166,092,364	205,406,411	459,495,602	466,144,937	499,096,345	529,512,444	6.1%	30,416,099
GOV	12,881,143	13,606,580	14,545,420	15,214,964	15,685,700	14,499,183	-7.6%	-1,186,517
TOTAL	1,878,760,942	1,921,404,327	2,332,267,446	2,564,248,241	2,701,347,858	2,762,730,576	2.3%	61,382,718
Annual Change		2.3%	21.4%	9.9%	5.3%	2.3%		

Table 1.11

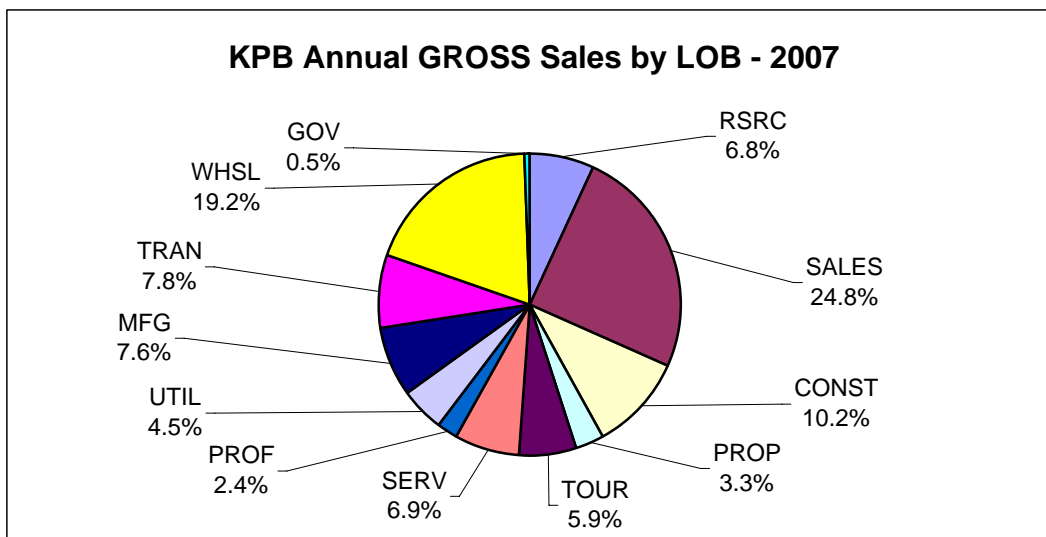

Chart 1.11

GROSS Sales Five Year Change by Line of Business				
LOB	2002	2007	Value Change	Percent Change
RSRC	176,421,465	188,963,094	12,541,629	7.1%
SALES	628,472,013	686,530,209	58,058,196	9.2%
CONST	212,755,561	280,808,993	68,053,432	32.0%
PROP	76,051,683	89,892,272	13,840,589	18.2%
TOUR	118,402,713	163,664,654	45,261,941	38.2%
SERV	121,513,322	191,799,629	70,286,307	57.8%
PROF	48,946,237	65,785,646	16,839,409	34.4%
UTIL	90,874,237	125,492,246	34,618,009	38.1%
MFG	138,105,065	211,307,879	73,202,814	53.0%
TRAN	88,245,139	214,474,327	126,229,188	143.0%
WHSL	166,092,364	529,512,444	363,420,080	218.8%
GOV	12,881,143	14,499,183	1,618,040	12.6%

Table 1.12

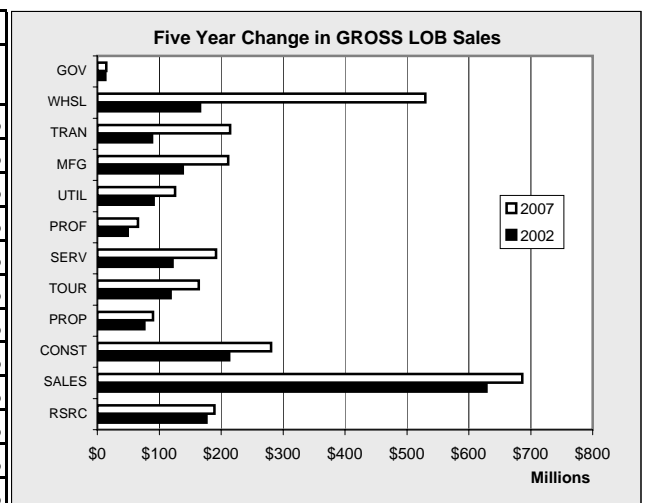

Chart 1.12

KPB Sales

KPB Annual TAXABLE Sales by Line of Business - 2002-2007 - in \$								
LOB	2002	2003	2004	2005	2006	2007	Annual Percent Change	Annual Amount Change
RSRC	6,576,292	5,915,297	6,153,343	5,324,332	5,512,905	6,294,070	14.2%	781,165
SALES	356,008,012	361,428,352	368,413,713	388,615,499	413,452,049	447,462,961	8.2%	34,010,912
CONST	11,241,233	11,542,579	11,018,998	10,645,534	11,205,138	12,094,817	7.9%	889,679
PROP	32,140,505	31,039,985	31,406,151	31,615,578	33,692,577	37,128,954	10.2%	3,436,377
TOUR	107,541,855	109,495,576	116,978,812	122,405,468	145,918,793	149,466,513	2.4%	3,547,720
SERV	75,988,405	73,889,109	76,895,205	79,730,637	85,720,706	95,821,995	11.8%	10,101,289
PROF	13,595,262	13,359,981	13,613,821	13,671,440	14,717,886	15,441,630	4.9%	723,744
UTIL	34,831,599	35,022,919	36,146,549	41,032,308	49,800,540	57,608,289	15.7%	7,807,749
MFG	7,047,802	6,983,538	7,398,649	8,450,709	9,467,466	9,838,378	3.9%	370,912
TRAN	32,535,661	32,500,864	34,930,999	38,357,426	25,802,136	37,640,268	45.9%	11,838,132
WHSL	35,421,522	40,287,728	66,025,347	73,132,431	78,895,658	81,865,128	3.8%	2,969,470
GOV	11,641,433	11,696,775	12,288,242	13,034,058	13,433,539	12,327,160	-8.2%	-1,106,379
TOTAL	724,569,581	733,162,703	781,269,829	826,015,420	887,619,393	962,990,163	8.5%	75,370,770
Annual Change		1.2%	6.6%	5.7%	7.5%	8.5%		

Table 1.13

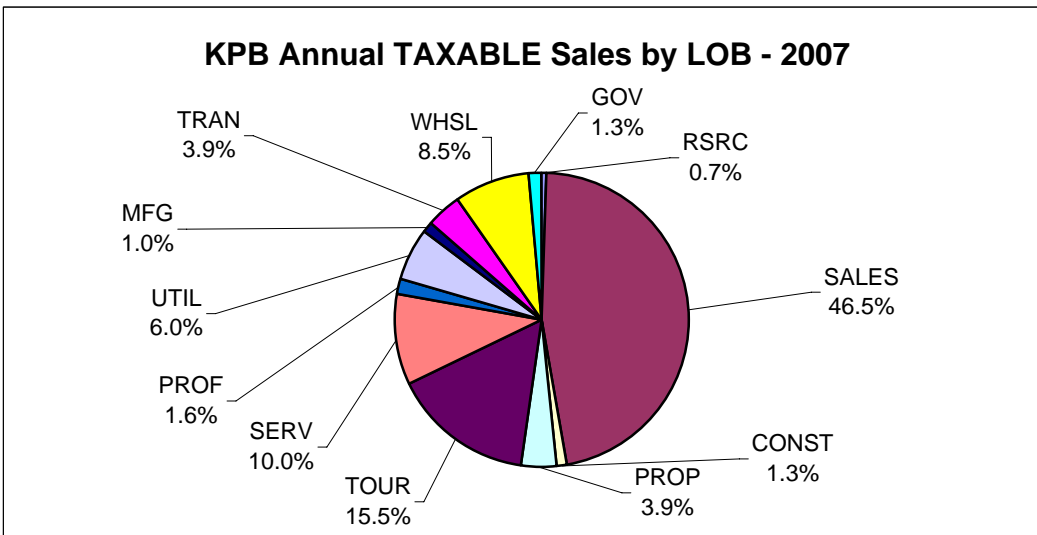

Chart 1.13

TAXABLE Sales Five Year Change by Line of Business				
LOB	2002	2007	Value Change	Percent Change
RSRC	6,576,292	6,294,070	-282,222	-4.3%
SALES	356,008,012	447,462,961	91,454,949	25.7%
CONST	11,241,233	12,094,817	853,584	7.6%
PROP	32,140,505	37,128,954	4,988,449	15.5%
TOUR	107,541,855	149,466,513	41,924,658	39.0%
SERV	75,988,405	95,821,995	19,833,590	26.1%
PROF	13,595,262	15,441,630	1,846,368	13.6%
UTIL	34,831,599	57,608,289	22,776,690	65.4%
MFG	7,047,802	9,838,378	2,790,576	39.6%
TRAN	32,535,661	37,640,268	5,104,607	15.7%
WHSL	35,421,522	81,865,128	46,443,606	131.1%
GOV	11,641,433	12,327,160	685,727	5.9%

Table 1.14

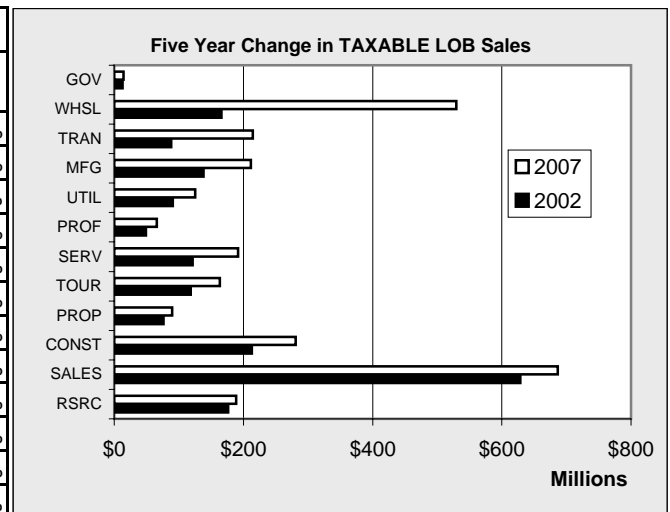

Chart 1.14

KPB Sales

KPB Annual GROSS Sales by Area - 2002-2007 - in \$

	2002	2003	2004	2005	2006	2007	Annual Percent Change	Annual Amount Change
Homer	263,240,684	274,073,782	290,381,849	310,153,119	356,264,408	348,698,971	-2.1%	-7,565,437
Kenai	279,302,714	282,924,495	407,297,440	465,525,121	456,316,282	513,792,001	12.6%	57,475,719
Seldovia	4,817,877	7,259,554	8,329,831	6,869,692	7,562,643	9,303,996	23.0%	1,741,353
Seward	142,369,626	156,961,936	166,196,695	189,348,054	198,565,283	191,373,024	-3.6%	-7,192,259
Soldotna	325,900,620	337,906,000	361,255,515	396,042,091	432,614,065	418,070,734	-3.4%	-14,543,331
Other	863,129,421	862,278,560	1,098,806,116	1,196,310,164	1,250,025,177	1,281,491,850	2.5%	31,466,673
Total	1,878,760,942	1,921,404,327	2,332,267,446	2,564,248,241	2,701,347,858	2,762,730,576	2.3%	61,382,718
Annual Change		2.3%	21.4%	9.9%	5.3%	2.3%		

Table 1.15

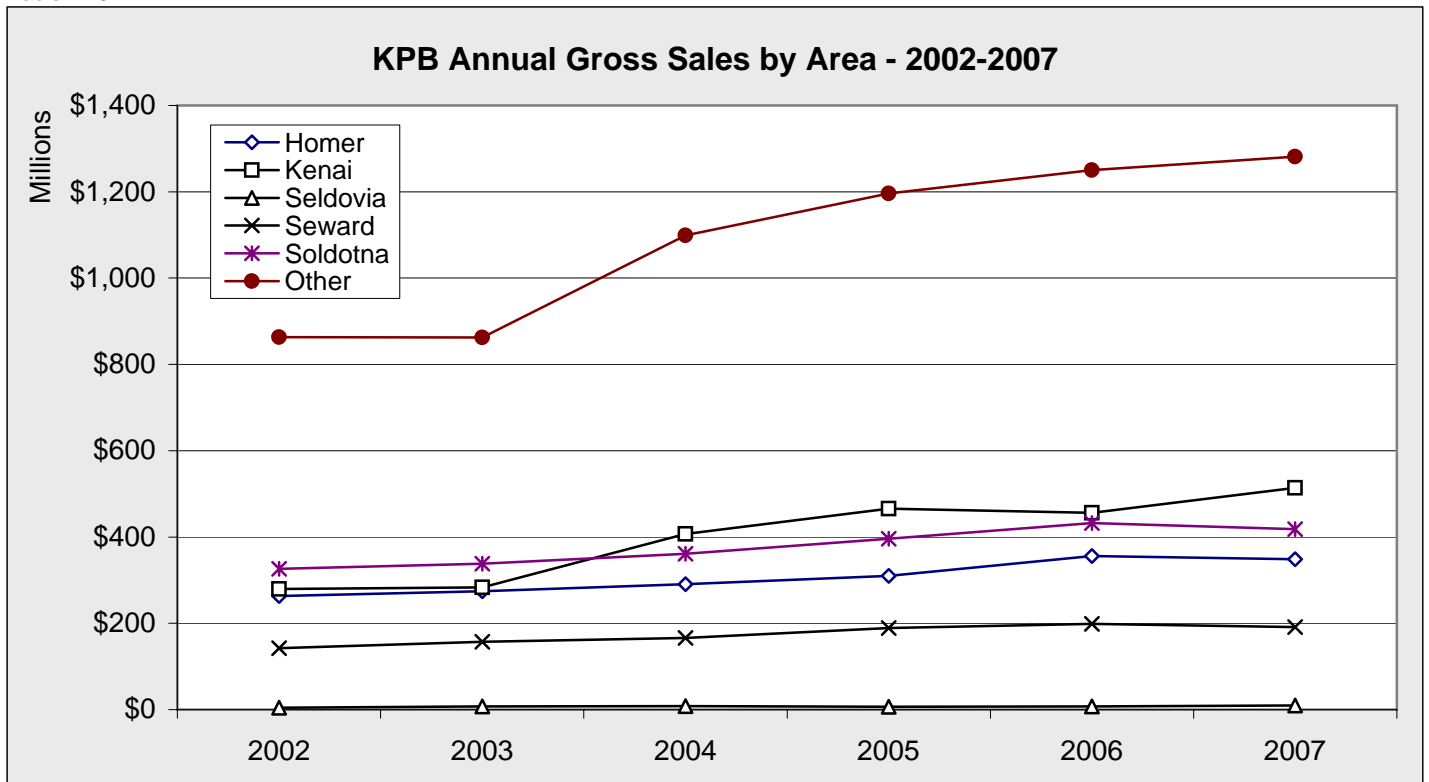

Chart 1.15

Gross Sales Five Year Change by Line of Business				
	2002	2007	Value Change	Percent Change
Homer	263,240,684	348,698,971	85,458,287	32.5%
Kenai	279,302,714	513,792,001	234,489,287	84.0%
Seldovia	4,817,877	9,303,996	4,486,119	93.1%
Seward	142,369,626	191,373,024	49,003,398	34.4%
Soldotna	325,900,620	418,070,734	92,170,114	28.3%
Other	863,129,421	1,281,491,850	418,362,429	48.5%

Table 1.16

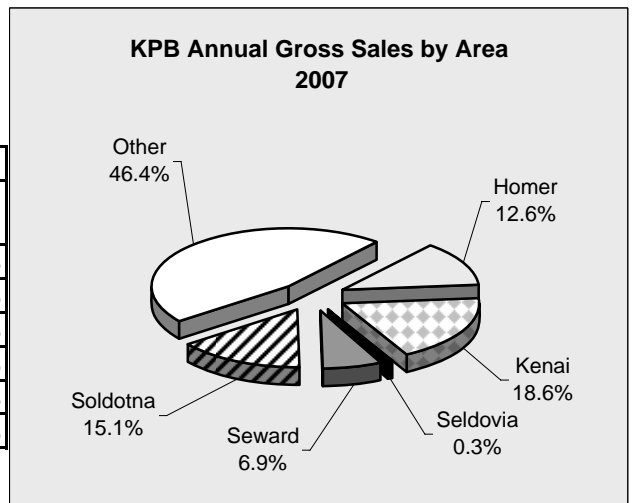

Chart 1.16

KPB Sales

KPB Annual TAXABLE Sales by Area - 2002-2007 - in \$

	2002	2003	2004	2005	2006	2007	Annual Percent Change	Annual Amount Change
Homer	121,292,548	131,729,196	139,933,678	145,661,104	153,301,890	164,285,716	7.2%	10,983,826
Kenai	136,685,248	121,356,795	139,399,127	145,107,627	155,818,914	163,945,082	5.2%	8,126,168
Seldovia	3,272,389	3,376,944	3,386,312	3,380,596	3,667,057	4,271,802	16.5%	604,745
Seward	75,590,722	76,348,733	79,948,305	88,009,283	91,026,610	100,489,096	10.4%	9,462,486
Soldotna	176,979,392	190,627,772	200,056,184	211,219,695	227,284,783	241,773,296	6.4%	14,488,513
Other	210,749,282	209,723,263	218,546,223	232,637,115	256,520,139	288,225,171	12.4%	31,705,032
Total	724,569,581	733,162,703	781,269,829	826,015,420	887,619,393	962,990,163	8.5%	75,370,770
Annual Change		1.2%	6.6%	5.7%	7.5%	8.5%		

Table 1.17

KPB Annual Taxable Sales by Area - 2002-2007

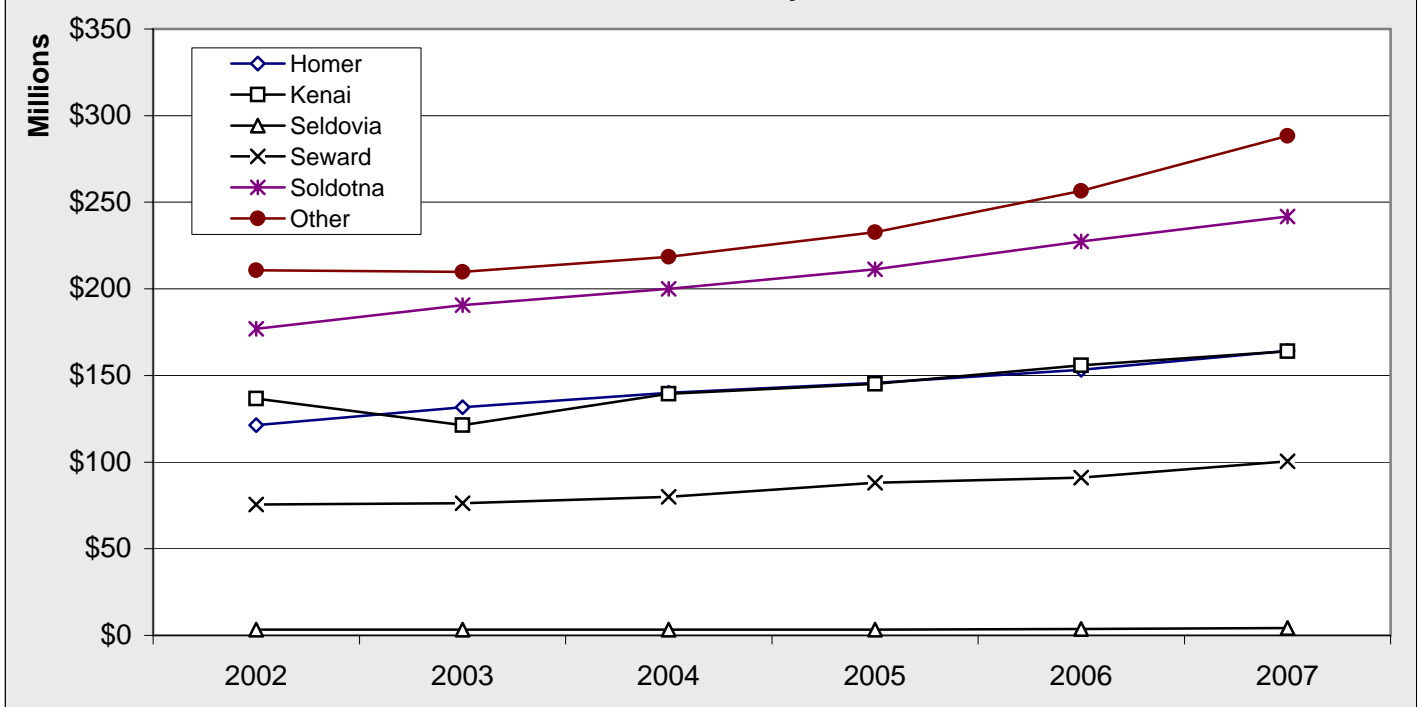

Chart 1.17

KPB Annual Taxable Sales by Area - 2007

Gross Sales Five Year Change by Line of Business				
	2002	2007	Value Change	Percent Change
Homer	121,292,548	164,285,716	42,993,168	35.4%
Kenai	136,685,248	163,945,082	27,259,834	19.9%
Seldovia	3,272,389	4,271,802	999,413	30.5%
Seward	75,590,722	100,489,096	24,898,374	32.9%
Soldotna	176,979,392	241,773,296	64,793,904	36.6%
Other	210,749,282	288,225,171	77,475,889	36.8%

Table 1.18

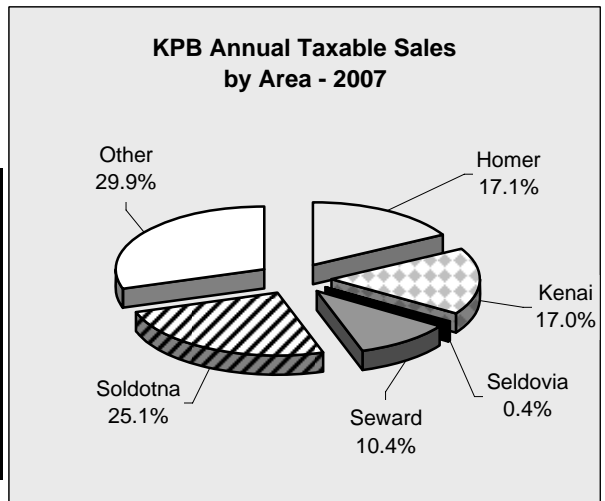

Chart 1.18

KPB Sales

KPB Annual GROSS Sales by LOB by Quarter - 2007 - in \$					
LOB	1st Quarter	2nd Quarter	3rd Quarter	4th Quarter	Total
RSRC	25,175,235	37,701,316	44,994,445	81,092,098	188,963,094
SALES	126,722,381	180,640,858	218,451,869	160,715,101	686,530,209
CONST	47,303,561	70,832,395	94,887,819	67,785,218	280,808,993
PROP	17,923,506	22,830,922	27,150,945	21,986,899	89,892,272
TOUR	19,147,705	47,222,810	80,192,621	17,101,518	163,664,654
SERV	36,791,799	53,326,945	57,499,506	44,181,379	191,799,629
PROF	14,924,733	15,370,019	16,505,699	18,985,195	65,785,646
UTIL	39,604,300	31,166,668	21,479,354	33,241,924	125,492,246
MFG	45,513,023	45,838,691	83,799,244	36,156,921	211,307,879
TRAN	38,144,630	49,399,534	81,955,602	44,974,561	214,474,327
WHSL	48,616,696	67,284,803	83,952,108	329,658,837	529,512,444
GOV	3,228,263	3,968,840	5,039,313	2,262,767	14,499,183
TOTAL	463,095,832	625,583,801	815,908,525	858,142,418	2,762,730,576

Table 1.19

KPB Annual GROSS Sales by Quarter by Area - 2007 - in \$					
	1st Quarter	2nd Quarter	3rd Quarter	4th Quarter	Total
Homer	61,416,940	97,343,260	113,704,551	76,234,220	348,698,971
Kenai	95,937,538	111,375,521	152,134,680	154,344,262	513,792,001
Seldovia	1,466,296	2,550,151	2,090,236	3,197,313	9,303,996
Seward	25,607,934	56,765,182	78,600,775	30,399,133	191,373,024
Soldotna	78,834,705	102,626,562	130,113,093	106,496,374	418,070,734
Other	199,832,419	254,923,124	339,265,190	487,471,117	1,281,491,850
Total	463,095,832	625,583,800	815,908,525	858,142,419	2,762,730,576

Table 1.20

KPB Annual TAXABLE Sales by LOB by Quarter - 2007 - in \$					
LOB	1st Quarter	2nd Quarter	3rd Quarter	4th Quarter	Total
RSRC	923,085	2,128,145	1,840,588	1,402,252	6,294,070
SALES	80,126,536	116,589,845	149,105,618	101,640,962	447,462,961
CONST	2,164,270	3,040,735	3,725,181	3,164,631	12,094,817
PROP	7,239,514	9,451,175	11,865,532	8,572,733	37,128,954
TOUR	16,421,369	43,938,399	73,431,229	15,675,516	149,466,513
SERV	19,391,120	26,007,085	28,357,673	22,066,117	95,821,995
PROF	3,815,678	4,266,419	4,036,386	3,323,147	15,441,630
UTIL	19,198,713	12,998,815	11,013,043	14,397,718	57,608,289
MFG	1,197,859	2,740,887	4,582,896	1,316,736	9,838,378
TRAN	1,010,861	11,505,114	23,632,611	1,491,682	37,640,268
WHSL	16,366,742	21,239,882	24,090,040	20,168,464	81,865,128
GOV	2,855,994	3,446,756	4,347,718	1,676,692	12,327,160
TOTAL	170,711,741	257,353,257	340,028,515	194,896,650	962,990,163

Table 1.21

KPB Annual TAXABLE Sales by Quarter by Area - 2007 - in \$					
	1st Quarter	2nd Quarter	3rd Quarter	4th Quarter	Total
Homer	27,254,042	47,215,996	59,406,793	30,408,885	164,285,716
Kenai	33,559,405	42,499,454	48,170,819	39,715,404	163,945,082
Seldovia	756,802	1,220,055	1,515,066	779,879	4,271,802
Seward	10,869,698	30,203,686	49,041,398	10,374,314	100,489,096
Soldotna	45,456,607	59,196,308	80,207,158	56,913,223	241,773,296
Other	52,815,187	77,017,758	101,687,281	56,704,945	288,225,171
Total	170,711,741	257,353,257	340,028,515	194,896,650	962,990,163

Table 1.22

KPB Sales

KPB Annual GROSS Sales by LOB by Quarter - 2006 - in \$					
LOB	1st Quarter	2nd Quarter	3rd Quarter	4th Quarter	Total
RSRC	41,396,946	44,041,225	62,756,576	73,192,527	221,387,274
SALES	118,284,156	177,971,487	204,896,547	150,908,209	652,060,399
CONST	31,762,779	59,487,724	96,833,688	174,370,810	362,455,001
PROP	17,389,025	22,499,793	25,580,855	24,079,310	89,548,983
TOUR	17,461,328	46,655,352	77,875,273	19,508,879	161,500,832
SERV	31,737,801	42,097,708	43,160,535	40,780,101	157,776,145
PROF	14,141,827	14,163,771	15,538,712	23,241,129	67,085,439
UTIL	32,447,128	26,961,172	26,505,508	35,102,472	121,016,280
MFG	20,053,636	54,696,750	67,955,048	34,596,361	177,301,795
TRAN	12,068,520	51,785,368	71,850,521	40,729,256	176,433,665
WHSL	47,732,057	68,379,600	77,919,710	305,064,978	499,096,345
GOV	3,126,281	3,670,790	4,731,516	4,157,113	15,685,700
TOTAL	387,601,484	612,410,740	775,604,489	925,731,145	2,701,347,858

Table 1.23

KPB Annual GROSS Sales by Quarter by Area - 2006 - in \$					
	1st Quarter	2nd Quarter	3rd Quarter	4th Quarter	Total
Homer	56,187,494	89,331,199	118,504,783	92,240,932	356,264,408
Kenai	63,192,410	109,236,492	121,522,565	162,364,815	456,316,282
Seldovia	1,517,120	2,169,837	2,520,816	1,354,870	7,562,643
Seward	21,700,942	51,137,438	75,794,619	49,932,284	198,565,283
Soldotna	72,457,043	99,023,371	121,179,864	139,953,787	432,614,065
Other	172,546,475	261,512,403	336,081,843	479,884,456	1,250,025,177
Total	387,601,484	612,410,740	775,604,490	925,731,144	2,701,347,858

Table 1.24

KPB Annual TAXABLE Sales by LOB by Quarter - 2006 - in \$					
LOB	1st Quarter	2nd Quarter	3rd Quarter	4th Quarter	Total
RSRC	893,012	1,872,018	1,508,186	1,239,689	5,512,905
SALES	73,876,142	108,416,675	136,193,060	94,966,172	413,452,049
CONST	1,970,457	2,976,145	3,272,532	2,986,004	11,205,138
PROP	6,890,443	8,213,624	10,444,120	8,144,390	33,692,577
TOUR	16,227,354	42,481,167	69,360,495	17,849,777	145,918,793
SERV	18,219,048	22,157,569	24,309,621	21,034,468	85,720,706
PROF	3,666,546	4,166,334	3,630,766	3,254,240	14,717,886
UTIL	14,962,505	10,663,883	9,087,067	15,087,085	49,800,540
MFG	1,249,704	2,405,086	4,148,232	1,664,444	9,467,466
TRAN	1,028,700	8,318,259	15,205,166	1,250,011	25,802,136
WHSL	15,226,750	20,819,810	24,110,681	18,738,417	78,895,658
GOV	2,683,072	3,244,865	4,214,700	3,290,902	13,433,539
TOTAL	156,893,733	235,735,435	305,484,626	189,505,599	887,619,393

Table 1.25

KPB Annual TAXABLE Sales by Quarter by Area - 2006 - in \$					
	1st Quarter	2nd Quarter	3rd Quarter	4th Quarter	Total
Homer	25,736,748	43,394,135	53,771,924	30,399,083	153,301,890
Kenai	32,270,822	40,988,235	45,146,046	37,413,811	155,818,914
Seldovia	636,694	973,525	1,347,778	709,060	3,667,057
Seward	10,170,398	26,596,215	42,413,740	11,846,257	91,026,610
Soldotna	42,117,457	55,444,444	75,550,142	54,172,740	227,284,783
Other	45,961,614	68,338,881	87,254,996	54,964,648	256,520,139
Total	156,893,733	235,735,435	305,484,626	189,505,599	887,619,393

Table 1.26

KPB Sales

KPB Annual GROSS Sales by LOB by Quarter - 2005 - in \$					
LOB	1st Quarter	2nd Quarter	3rd Quarter	4th Quarter	Total
RSRC	38,251,823	34,048,262	41,809,634	122,190,206	236,299,925
SALES	111,193,705	166,017,486	192,999,505	139,250,296	609,460,992
CONST	38,216,464	65,845,562	74,970,891	111,048,336	290,081,253
PROP	14,911,823	20,396,774	23,602,564	23,665,316	82,576,477
TOUR	16,156,087	38,843,750	62,861,416	18,011,781	135,873,034
SERV	28,118,441	36,262,174	38,830,826	35,864,223	139,075,664
PROF	12,543,218	11,892,847	13,331,049	21,643,226	59,410,340
UTIL	27,279,722	23,278,511	26,333,258	26,579,805	103,471,296
MFG	32,787,316	58,077,269	115,613,182	42,020,585	248,498,352
TRAN	25,924,424	54,780,936	56,292,143	41,143,504	178,141,007
WHSL	55,789,694	65,590,107	74,831,138	269,933,998	466,144,937
GOV	2,999,901	3,414,800	4,874,984	3,925,279	15,214,964
TOTAL	404,172,618	578,448,478	726,350,590	855,276,555	2,564,248,241

Table 1.27

KPB Annual GROSS Sales by Quarter by Area - 2005 - in \$					
	1st Quarter	2nd Quarter	3rd Quarter	4th Quarter	Total
Homer	51,881,645	86,186,468	101,485,822	70,599,184	310,153,119
Kenai	75,559,340	102,447,996	112,280,604	175,237,181	465,525,121
Seldovia	1,261,735	2,120,534	2,274,951	1,212,472	6,869,692
Seward	26,468,833	58,467,271	70,190,050	34,221,900	189,348,054
Soldotna	65,956,145	87,639,989	113,946,286	128,499,671	396,042,091
Other	183,044,920	241,586,220	326,172,877	445,506,147	1,196,310,164
Total	404,172,618	578,448,478	726,350,590	855,276,555	2,564,248,241

Table 1.28

KPB Annual TAXABLE Sales by LOB by Quarter - 2005 - in \$					
LOB	1st Quarter	2nd Quarter	3rd Quarter	4th Quarter	Total
RSRC	990,918	1,834,410	1,289,244	1,209,760	5,324,332
SALES	69,173,718	102,667,988	127,853,397	88,920,396	388,615,499
CONST	1,959,724	2,915,622	3,084,855	2,685,333	10,645,534
PROP	6,515,789	7,804,653	9,706,546	7,588,590	31,615,578
TOUR	14,935,051	34,993,783	55,745,998	16,730,636	122,405,468
SERV	17,180,280	20,833,769	22,292,483	19,424,105	79,730,637
PROF	3,481,938	3,655,359	3,490,168	3,043,975	13,671,440
UTIL	12,169,072	9,357,261	8,389,891	11,116,084	41,032,308
MFG	772,962	1,985,375	3,905,015	1,787,357	8,450,709
TRAN	1,052,769	12,377,119	23,343,654	1,583,884	38,357,426
WHSL	13,543,440	19,096,007	22,162,375	18,330,609	73,132,431
GOV	2,575,030	3,081,459	4,282,656	3,094,913	13,034,058
TOTAL	144,350,691	220,602,805	285,546,282	175,515,642	826,015,420

Table 1.29

KPB Annual TAXABLE Sales by Quarter by Area - 2005 - in \$					
	1st Quarter	2nd Quarter	3rd Quarter	4th Quarter	Total
Homer	24,333,243	41,492,825	51,146,949	28,688,087	145,661,104
Kenai	29,504,912	37,403,239	42,564,550	35,634,926	145,107,627
Seldovia	573,017	932,141	1,215,292	660,146	3,380,596
Seward	10,090,985	25,367,609	41,123,476	11,427,213	88,009,283
Soldotna	38,714,672	52,145,244	69,956,303	50,403,476	211,219,695
Other	41,133,862	63,261,747	79,539,712	48,701,794	232,637,115
Total	144,350,691	220,602,805	285,546,282	175,515,642	826,015,420

Table 1.30

KPB Sales

KPB Annual GROSS Sales by LOB by Quarter - 2004 - in \$					
LOB	1st Quarter	2nd Quarter	3rd Quarter	4th Quarter	Total
RSRC	36,931,888	29,294,221	36,492,249	148,051,876	250,770,234
SALES	107,357,845	156,640,368	184,804,709	139,436,960	588,239,882
CONST	25,675,314	39,102,973	61,984,414	95,902,592	222,665,293
PROP	16,557,624	18,026,457	22,336,343	23,320,188	80,240,612
TOUR	16,011,089	37,215,072	58,960,765	17,701,354	129,888,280
SERV	25,765,288	33,527,834	36,331,106	41,607,086	137,231,314
PROF	11,505,526	12,538,803	14,251,398	20,815,253	59,110,980
UTIL	22,389,233	21,026,192	21,147,612	22,946,239	87,509,276
MFG	24,108,267	14,796,050	106,872,238	33,856,320	179,632,875
TRAN	12,385,881	35,953,843	60,047,304	14,550,650	122,937,678
WHSL	59,563,838	76,293,809	83,731,170	239,906,785	459,495,602
GOV	2,655,152	3,257,219	4,414,140	4,218,909	14,545,420
TOTAL	360,906,945	477,672,841	691,373,448	802,314,212	2,332,267,446

Table 1.31

KPB Annual GROSS Sales by Quarter by Area - 2004 - in \$					
	1st Quarter	2nd Quarter	3rd Quarter	4th Quarter	Total
Homer	48,141,586	75,752,214	93,892,260	72,595,789	290,381,849
Kenai	61,083,004	80,388,089	97,860,710	167,965,637	407,297,440
Seldovia	1,405,047	1,971,670	1,809,067	3,144,047	8,329,831
Seward	21,175,289	42,749,272	63,911,158	38,360,976	166,196,695
Soldotna	69,929,668	89,310,129	107,194,955	94,820,763	361,255,515
Other	159,172,351	187,501,467	326,705,298	425,427,000	1,098,806,116
Total	360,906,945	477,672,841	691,373,448	802,314,212	2,332,267,446

Table 1.32

KPB Annual TAXABLE Sales by LOB by Quarter - 2004 - in \$					
LOB	1st Quarter	2nd Quarter	3rd Quarter	4th Quarter	Total
RSRC	1,006,024	1,822,647	1,941,700	1,382,972	6,153,343
SALES	67,252,378	96,283,124	120,218,938	84,659,273	368,413,713
CONST	2,213,933	2,918,853	3,201,763	2,684,449	11,018,998
PROP	6,528,225	7,927,956	9,584,035	7,365,935	31,406,151
TOUR	14,794,235	33,690,401	52,349,535	16,144,641	116,978,812
SERV	16,744,299	19,940,356	21,422,515	18,788,035	76,895,205
PROF	3,436,148	3,761,871	3,392,927	3,022,875	13,613,821
UTIL	10,793,658	7,946,772	7,603,622	9,802,497	36,146,549
MFG	810,240	1,847,946	3,620,567	1,119,896	7,398,649
TRAN	976,041	10,755,001	22,056,399	1,143,558	34,930,999
WHSL	12,961,538	17,390,769	19,671,722	16,001,318	66,025,347
GOV	2,390,321	2,997,995	4,020,402	2,879,524	12,288,242
TOTAL	139,907,040	207,283,691	269,084,125	164,994,973	781,269,829

Table 1.33

KPB Annual TAXABLE Sales by Quarter by Area - 2004 - in \$					
	1st Quarter	2nd Quarter	3rd Quarter	4th Quarter	Total
Homer	23,824,920	39,648,524	48,969,328	27,490,906	139,933,678
Kenai	29,556,491	36,263,788	40,043,041	33,535,807	139,399,127
Seldovia	566,726	939,589	1,182,138	697,859	3,386,312
Seward	9,496,108	22,991,903	37,073,868	10,386,426	79,948,305
Soldotna	37,385,342	49,011,743	66,179,805	47,479,294	200,056,184
Other	39,077,453	58,428,144	75,635,945	45,404,681	218,546,223
Total	139,907,040	207,283,691	269,084,125	164,994,973	781,269,829

Table 1.34

KPB Construction Permits

Construction Permitting

Construction permits are not required within the KPB except within the incorporated cities of Homer, Kenai, Seldovia, Seward and Soldotna; therefore, data reported in this document does not include all KPB construction activity. It does, however, provide city trends. Permit categories include Residential New (RN), Residential Alteration/Addition (RA), Commercial New (CN) and Commercial Alteration/Addition (CA). Individual cities may have other categories, but in an effort to provide category consistency, city categories have been combined into one of the four. Borough-wide new residential construction per the KPB Assessing Department is presented in the annual statistical report, *Situations and Prospects*. Homer, Kenai, Seldovia and Soldotna permit activity has been recorded since 1986 but Seward did not require building permits until 1988.

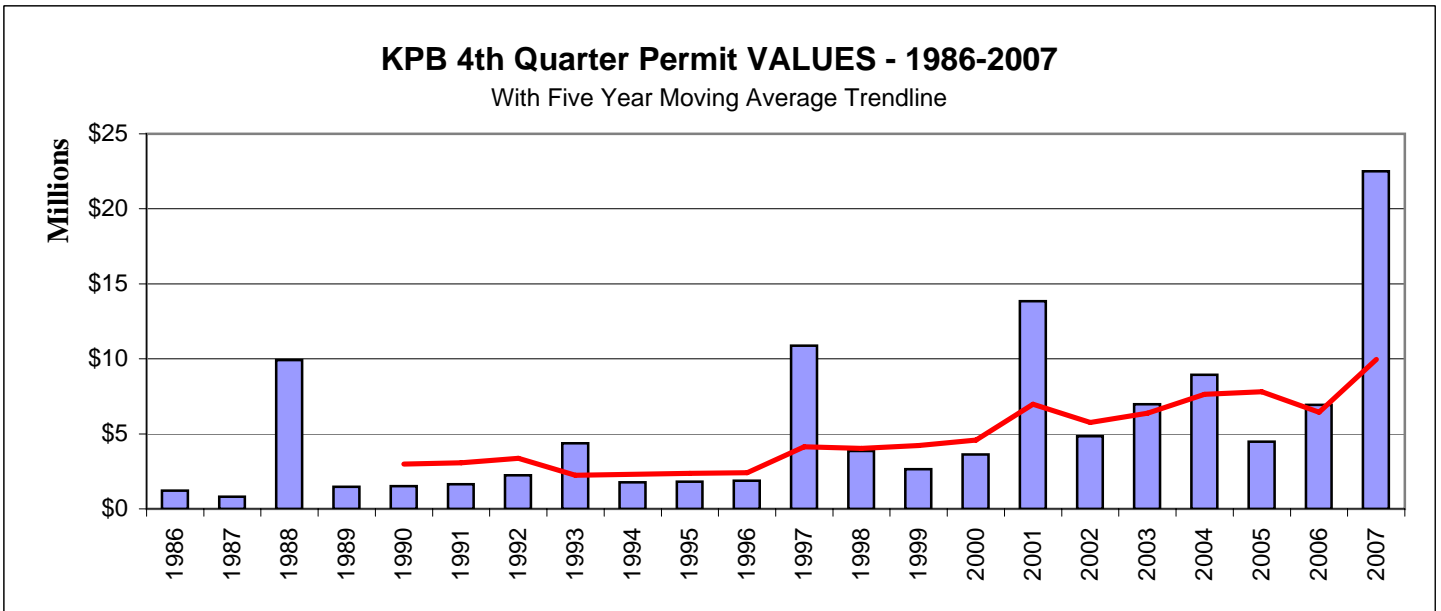

Chart 1.19

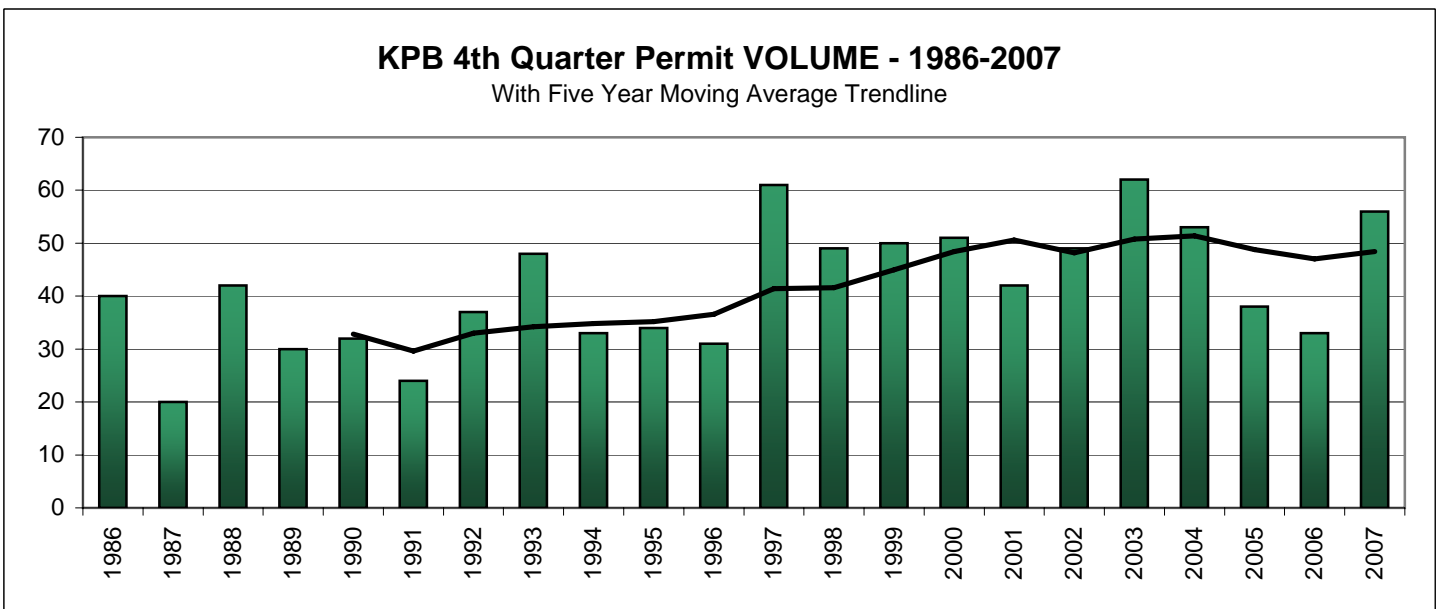

Chart 1.20

KPB Construction Permits

KPB 4th Quarter Permit VALUES by Area - 2002-2007 - in \$							
	2002	2003	2004	2005	2006	2007	Annual Change
Homer	814,520	3,042,900	3,391,000	2,977,000	2,555,000	1,622,000	-36.5%
Kenai	1,527,800	2,455,500	585,400	1,220,000	1,787,900	439,700	-75.4%
Seldovia	20,000	36,500	0	500	18,000	1,000	-94.4%
Seward	2,232,800	572,500	259,350	106,857	1,944,300	18,139,500	833.0%
Soldotna	257,500	873,045	4,703,915	169,840	632,882	2,292,045	262.2%
Total	4,852,620	6,980,445	8,939,665	4,474,197	6,938,082	22,494,245	224.2%
Annual Change		43.8%	28.1%	-50.0%	55.1%	224.2%	

Table 1.35

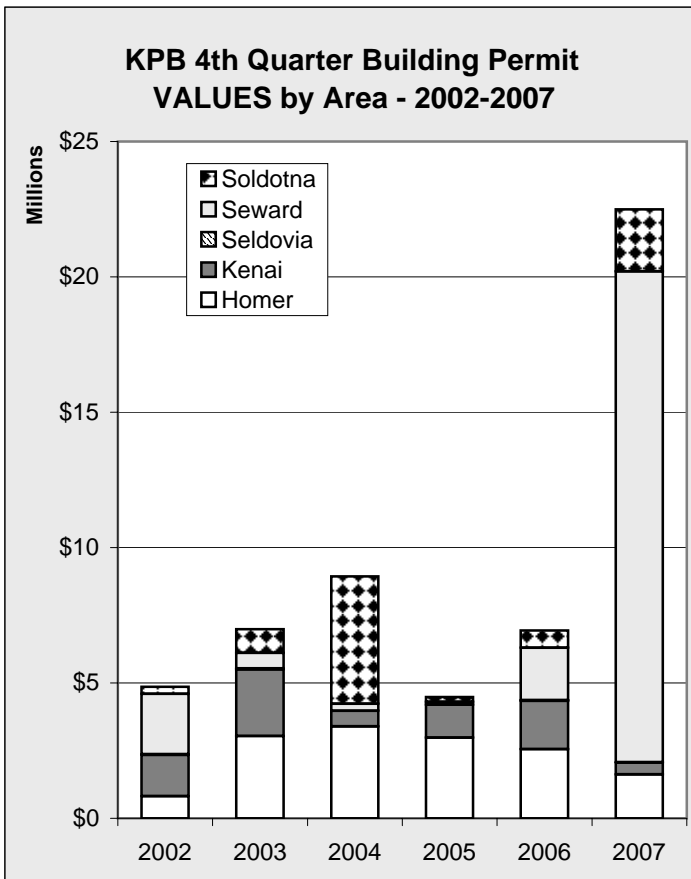

Chart 1.21

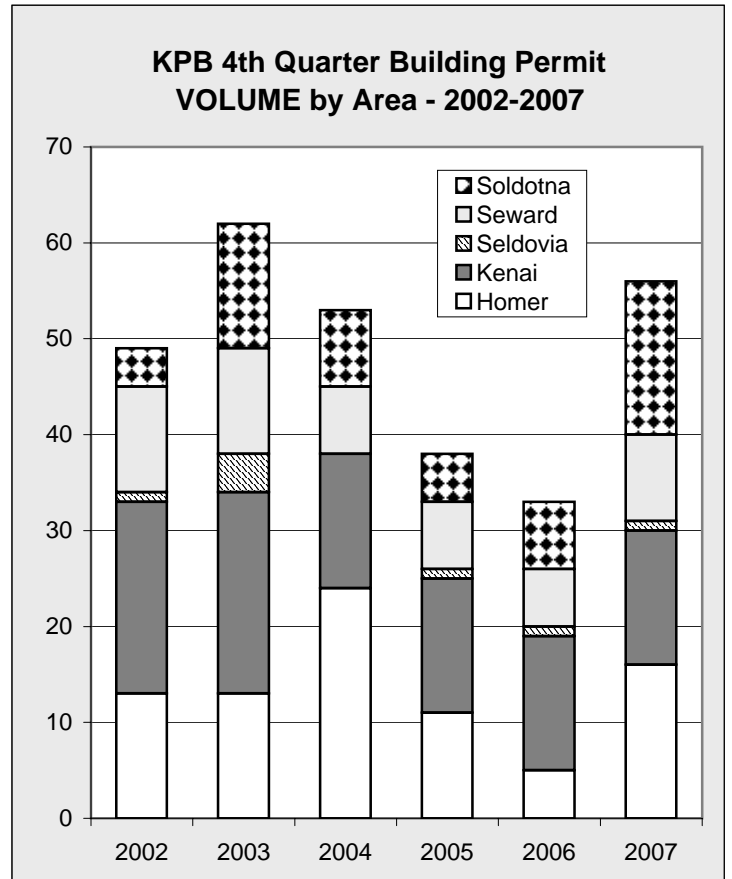

Chart 1.22

KPB 4th Quarter Permit VOLUME by Area - 2002-2007							
	2002	2003	2004	2005	2006	2007	Annual Change
Homer	13	13	24	11	5	16	220.0%
Kenai	20	21	14	14	14	14	0.0%
Seldovia	1	4	0	1	1	1	0.0%
Seward	11	11	7	7	6	9	50.0%
Soldotna	4	13	8	5	7	16	128.6%
Total	49	62	53	38	33	56	69.7%
Annual Change		26.5%	-14.5%	-28.3%	-13.2%	69.7%	

Table 1.36

KPB Construction Permits

KPB 4th Quarter Permit VALUES by Type - 2002-2007 - in \$							
	2002	2003	2004	2005	2006	2007	Annual Change
Residential New	1,113,200	2,554,091	1,153,860	2,007,623	2,056,833	933,000	-54.6%
Residential Alter/Add	225,620	291,000	529,454	200,957	307,359	876,365	185.1%
Commercial New	3,168,000	2,146,991	3,061,601	2,163,000	4,271,300	19,955,112	367.2%
Commercial Alter/Add	345,800	1,988,363	4,194,750	102,617	302,590	729,768	141.2%
Total	4,852,620	6,980,445	8,939,665	4,474,197	6,938,082	22,494,245	224.2%
Annual Change		43.8%	28.1%	-50.0%	55.1%	224.2%	

Table 1.37

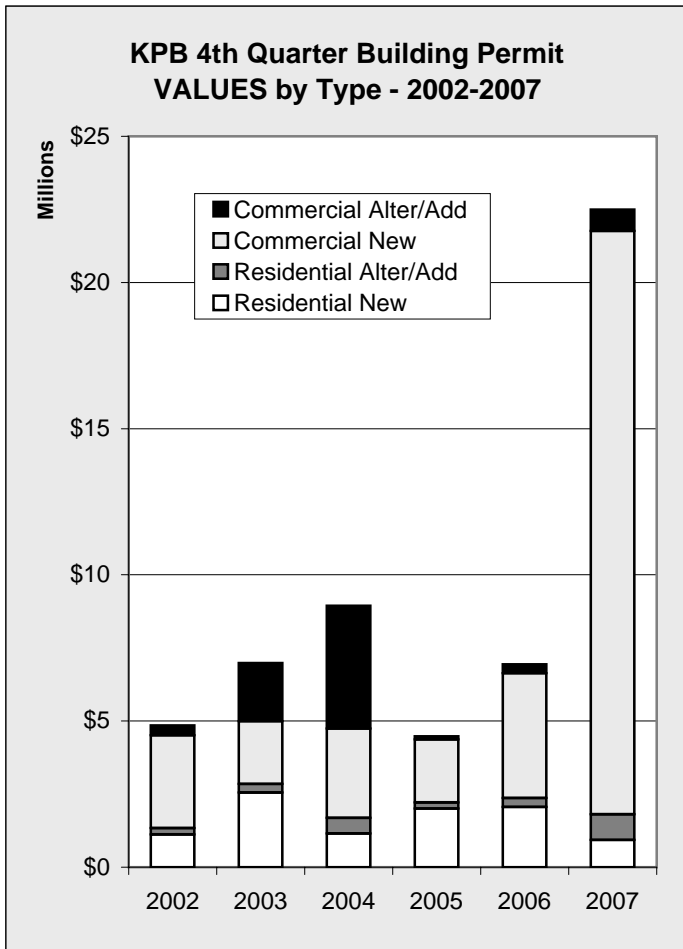

Chart 1.23

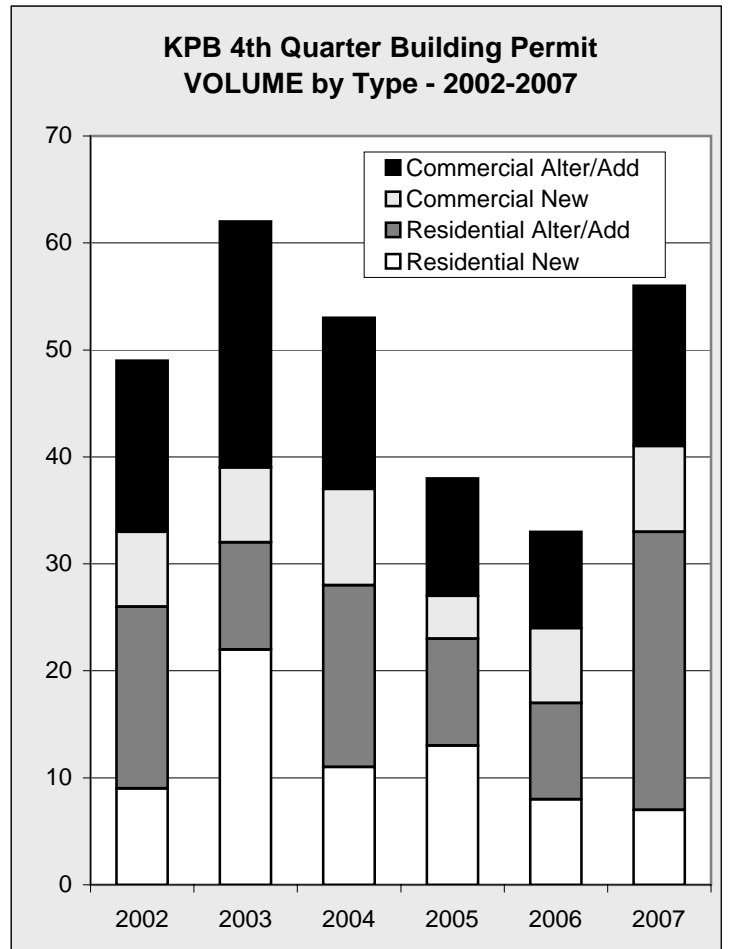

Chart 1.24

KPB 4th Quarter Permit VOLUME by Type - 2002-2007							
	2002	2003	2004	2005	2006	2007	Annual Change
Residential New	9	22	11	13	8	7	-12.5%
Residential Alter/Add	17	10	17	10	9	26	188.9%
Commercial New	7	7	9	4	7	8	14.3%
Commercial Alter/Add	16	23	16	11	9	15	66.7%
Total	49	62	53	38	33	56	69.7%
Annual Change		26.5%	-14.5%	-28.3%	-13.2%	69.7%	

Table 1.38

KPB Construction Permits

KPB Annual Permit VALUES by Area - 2002 - 2007 - in \$							
	2002	2003	2004	2005	2006	2007	Annual Change
Homer	10,048,779	15,326,815	24,070,631	21,611,400	20,287,857	14,066,201	-30.7%
Kenai	16,799,400	10,441,800	4,786,550	8,237,900	11,076,154	22,398,000	102.2%
Seldovia	356,500	1,902,500	176,200	512,000	135,000	343,800	154.7%
Seward	7,910,703	7,982,765	17,711,150	2,863,143	25,537,249	21,095,925	-17.4%
Soldotna	11,163,894	7,952,297	37,296,926	11,509,360	23,194,400	13,762,923	-40.7%
Total	46,279,276	43,606,177	84,041,457	44,733,803	80,230,660	71,666,849	-10.7%
Annual Change		-5.8%	92.7%	-46.8%	79.4%	-10.7%	

Table 1.39

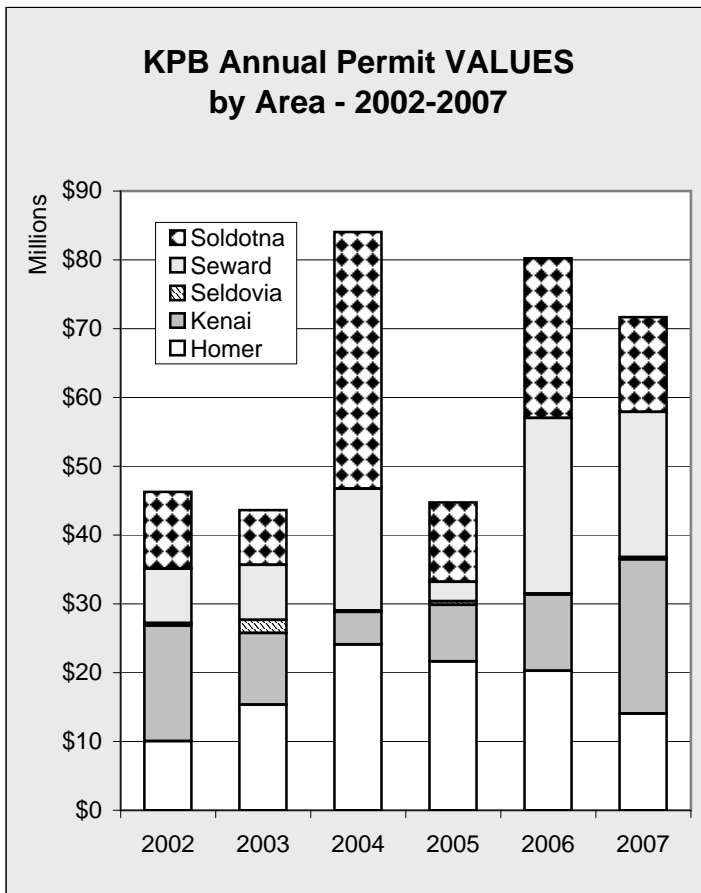

Chart 1.25

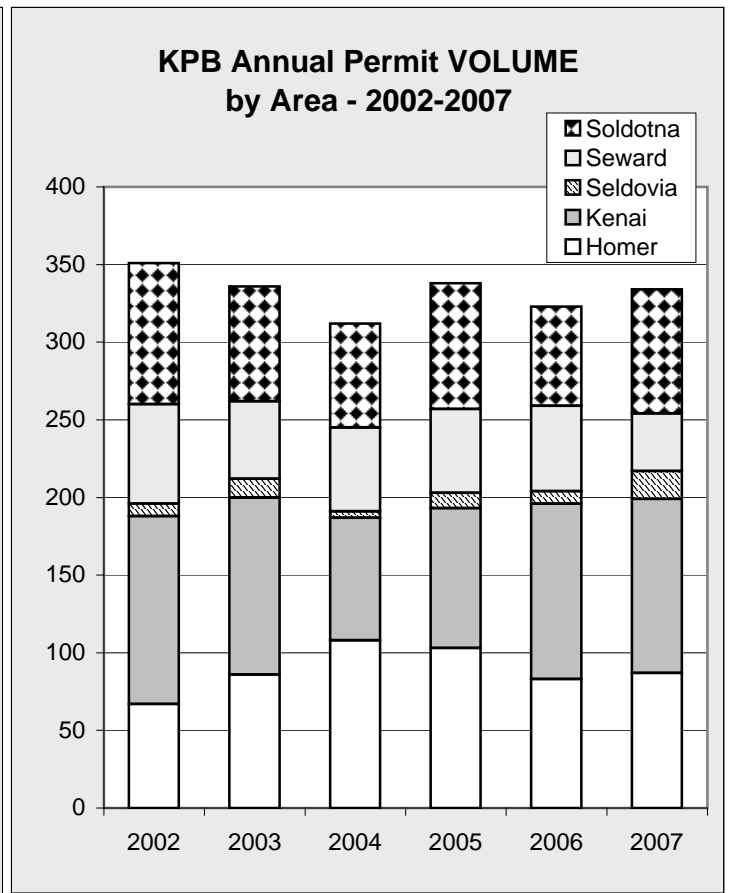

Chart 1.26

KPB Annual Permit VOLUME by Area - 2002 - 2007							
	2002	2003	2004	2005	2006	2007	Annual Change
Homer	67	86	108	103	83	87	4.8%
Kenai	121	114	79	90	113	112	-0.9%
Seldovia	8	12	4	10	8	18	125.0%
Seward	64	50	54	54	55	37	-32.7%
Soldotna	91	74	67	81	64	80	25.0%
Total	351	336	312	338	323	334	3.4%
Annual Change		-4.3%	-7.1%	8.3%	-4.4%	3.4%	

Table 1.40

KPB Construction Permits

KPB Annual Permit VALUES by Type - 2002-2007 - in \$							
	2002	2003	2004	2005	2006	2007	Annual Change
Residential New	14,358,064	15,729,888	15,935,344	17,749,648	26,277,740	22,612,367	-13.9%
Residential Alter/Add	2,305,815	2,280,779	2,880,284	2,235,128	2,070,180	4,106,440	98.4%
Commercial New	21,793,729	15,820,201	56,079,343	19,217,548	44,002,152	33,961,168	-22.8%
Commercial Alter/Add	7,821,668	9,775,309	9,146,486	5,531,479	7,880,588	10,986,874	39.4%
Total	46,279,276	43,606,177	84,041,457	44,733,803	80,230,660	71,666,849	-10.7%
Annual Change		-5.8%	92.7%	-46.8%	79.4%	-10.7%	

Table 1.41

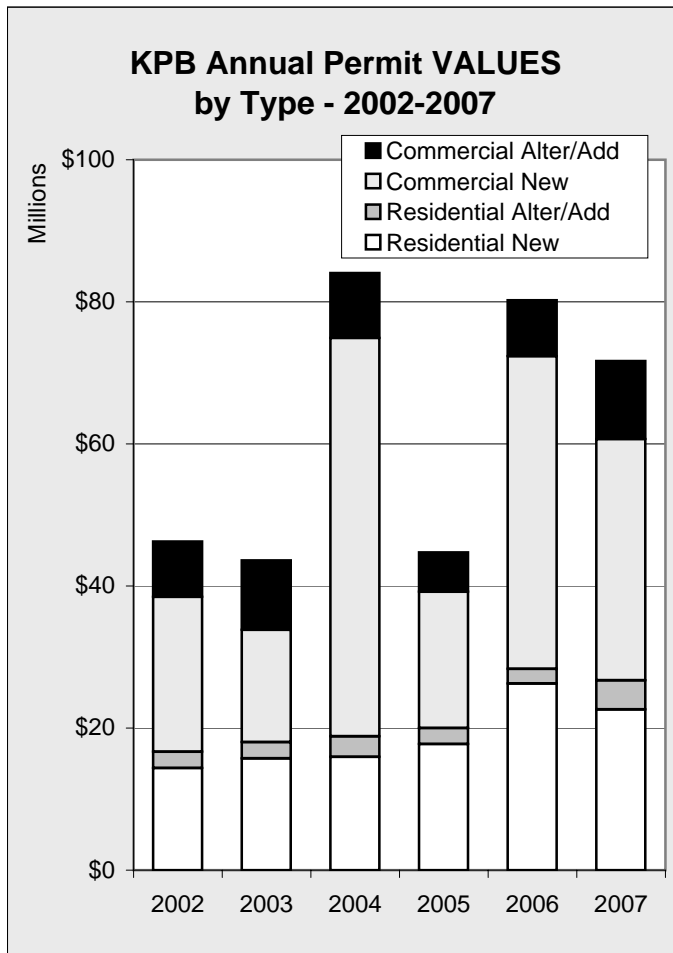

Chart 1.27

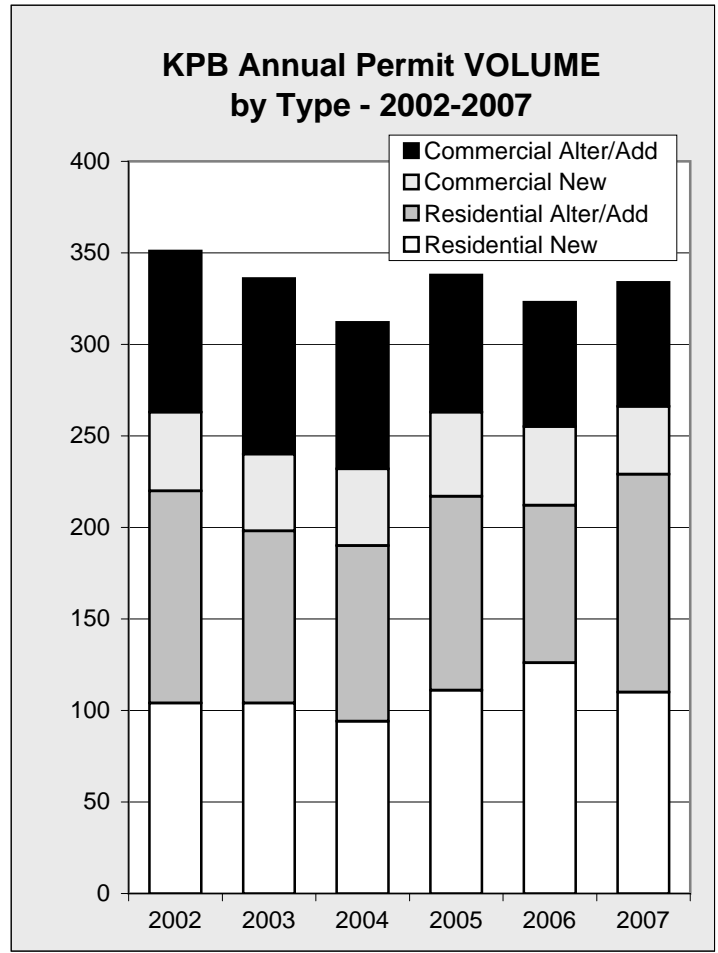

Chart 1.28

KPB Annual Permit VOLUME by Type - 2002-2007							
	2002	2003	2004	2005	2006	2007	Annual Change
Residential New	104	104	94	111	126	110	-12.7%
Residential Alter/Add	116	94	96	106	86	119	38.4%
Commercial New	43	42	42	46	43	37	-14.0%
Commercial Alter/Add	88	96	80	75	68	68	0.0%
Total	351	336	312	338	323	334	3.4%
Annual Change		-4.3%	-7.1%	8.3%	-4.4%	3.4%	

Table 1.42

KPB Construction Permits

KPB Annual Permit VALUE by AREA by Quarter - 2001-2007 - in \$					
	1st Quarter	2nd Quarter	3rd Quarter	4th Quarter	TOTAL
2001					
Homer	690,000	4,102,040	2,996,350	12,012,300	19,800,690
Kenai	819,500	7,597,900	4,506,200	655,300	13,578,900
Seldovia	10,000	25,000	15,525	15,000	65,525
Seward	416,700	666,239	642,042	992,000	2,716,981
Soldotna	3,051,218	3,231,190	2,509,916	162,648	8,954,972
TOTAL	4,987,418	15,622,369	10,670,033	13,837,248	45,117,068
2002					
Homer	928,720	2,528,209	5,777,330	814,520	10,048,779
Kenai	3,888,200	4,569,400	6,814,000	1,527,800	16,799,400
Seldovia	10,000	8,000	318,500	20,000	356,500
Seward	481,440	3,888,887	1,307,576	2,232,800	7,910,703
Soldotna	1,205,590	7,003,458	2,697,346	257,500	11,163,894
TOTAL	6,513,950	17,997,954	16,914,752	4,852,620	46,279,276
2003					
Homer	1,334,340	7,929,500	3,020,075	3,042,900	15,326,815
Kenai	1,557,600	2,728,350	3,700,350	2,455,500	10,441,800
Seldovia	31,000	0	1,835,000	36,500	1,902,500
Seward	1,905,355	3,672,010	1,832,900	572,500	7,982,765
Soldotna	427,018	4,233,924	2,418,310	873,045	7,952,297
TOTAL	5,255,313	18,563,784	12,806,635	6,980,445	43,606,177
2004					
Homer	3,714,020	7,433,711	9,531,900	3,391,000	24,070,631
Kenai	312,000	1,897,400	1,991,750	585,400	4,786,550
Seldovia	20,000	156,200	0	0	176,200
Seward	7,741,600	7,443,900	2,266,300	259,350	17,711,150
Soldotna	5,064,323	3,748,573	23,780,115	4,703,915	37,296,926
TOTAL	16,851,943	20,679,784	37,570,065	8,939,665	84,041,457
2005					
Homer	3,105,900	11,246,000	4,282,500	2,977,000	21,611,400
Kenai	425,500	2,557,300	4,035,100	1,220,000	8,237,900
Seldovia	15,000	466,000	30,500	500	512,000
Seward	1,172,300	758,540	825,446	106,857	2,863,143
Soldotna	1,421,555	6,832,235	3,085,730	169,840	11,509,360
TOTAL	6,140,255	21,860,075	12,259,276	4,474,197	44,733,803
2006					
Homer	3,271,000	7,467,100	6,994,757	2,555,000	20,287,857
Kenai	763,500	4,157,100	4,367,654	1,787,900	11,076,154
Seldovia	30,000	87,000	0	18,000	135,000
Seward	622,217	2,184,672	20,786,060	1,944,300	25,537,249
Soldotna	2,116,441	7,231,328	13,213,749	632,882	23,194,400
TOTAL	6,803,158	21,127,200	45,362,220	6,938,082	80,230,660
2007					
Homer	0	7,357,001	5,087,200	1,622,000	14,066,201
Kenai	769,500	6,168,100	15,020,700	439,700	22,398,000
Seldovia	15,000	267,000	60,800	1,000	343,800
Seward	803,238	1,888,287	264,900	18,139,500	21,095,925
Soldotna	827,771	7,877,205	2,765,902	2,292,045	13,762,923
TOTAL	2,415,509	23,557,593	23,199,502	22,494,245	71,666,849

Table 1.43

KPB Construction Permits

KPB Annual Permit VALUE by TYPE by Quarter - 2001-2007 - in \$					
	1st Quarter	2nd Quarter	3rd Quarter	4th Quarter	TOTAL
2001					
Residential New	923,000	7,367,801	3,984,532	1,116,300	13,391,633
Residential Alter/Add	356,860	758,779	531,907	348,948	1,996,494
Commercial New	2,958,578	5,384,800	2,707,972	514,000	11,565,350
Commercial Alter/Add	748,980	2,110,989	3,445,622	11,858,000	18,163,591
TOTAL	4,987,418	15,622,369	10,670,033	13,837,248	45,117,068
2002					
Residential New	1,531,609	6,145,753	5,567,502	1,113,200	14,358,064
Residential Alter/Add	159,391	1,044,943	875,861	225,620	2,305,815
Commercial New	4,294,006	8,376,305	5,955,418	3,168,000	21,793,729
Commercial Alter/Add	528,944	2,430,953	4,515,971	345,800	7,821,668
TOTAL	6,513,950	17,997,954	16,914,752	4,852,620	46,279,276
2003					
Residential New	1,097,800	7,868,834	4,209,163	2,554,091	15,729,888
Residential Alter/Add	393,867	984,340	611,572	291,000	2,280,779
Commercial New	72,000	8,965,210	4,636,000	2,146,991	15,820,201
Commercial Alter/Add	3,691,646	745,400	3,349,900	1,988,363	9,775,309
TOTAL	5,255,313	18,563,784	12,806,635	6,980,445	43,606,177
2004					
Residential New	3,456,797	6,374,487	4,950,200	1,153,860	15,935,344
Residential Alter/Add	261,520	483,839	1,605,471	529,454	2,880,284
Commercial New	12,880,026	11,147,815	28,989,901	3,061,601	56,079,343
Commercial Alter/Add	253,600	2,673,643	2,024,493	4,194,750	9,146,486
TOTAL	16,851,943	20,679,784	37,570,065	8,939,665	84,041,457
2005					
Residential New	3,338,356	7,560,499	4,843,170	2,007,623	17,749,648
Residential Alter/Add	415,930	812,470	805,771	200,957	2,235,128
Commercial New	309,000	11,897,148	4,848,400	2,163,000	19,217,548
Commercial Alter/Add	2,076,969	1,589,958	1,761,935	102,617	5,531,479
TOTAL	6,140,255	21,860,075	12,259,276	4,474,197	44,733,803
2006					
Residential New	2,257,031	10,219,599	11,744,277	2,056,833	26,277,740
Residential Alter/Add	45,000	830,630	887,191	307,359	2,070,180
Commercial New	938,410	8,135,648	30,656,794	4,271,300	44,002,152
Commercial Alter/Add	3,562,717	1,941,323	2,073,958	302,590	7,880,588
TOTAL	6,803,158	21,127,200	45,362,220	6,938,082	80,230,660
2007					
Residential New	1,062,722	15,087,392	5,529,253	933,000	22,612,367
Residential Alter/Add	308,549	1,456,488	1,465,038	876,365	4,106,440
Commercial New	208,513	4,447,143	9,350,400	19,955,112	33,961,168
Commercial Alter/Add	835,725	2,566,570	6,854,811	729,768	10,986,874
TOTAL	2,415,509	23,557,593	23,199,502	22,494,245	71,666,849

Table 1.44

KPB Construction Permits

KPB Annual Permit VOLUME by AREA by Quarter - 2001-2007					
	1st Quarter	2nd Quarter	3rd Quarter	4th Quarter	TOTAL
2001					
Homer	7	34	22	9	72
Kenai	11	42	23	11	87
Seldovia	1	1	5	2	9
Seward	11	14	14	9	48
Soldotna	10	37	35	11	93
TOTAL	40	128	99	42	309
2002					
Homer	10	17	27	13	67
Kenai	5	37	59	20	121
Seldovia	1	2	4	1	8
Seward	10	29	14	11	64
Soldotna	11	51	25	4	91
TOTAL	37	136	129	49	351
2003					
Homer	18	34	21	13	86
Kenai	8	40	45	21	114
Seldovia	3	0	5	4	12
Seward	11	13	15	11	50
Soldotna	6	36	19	13	74
TOTAL	46	123	105	62	336
2004					
Homer	16	26	42	24	108
Kenai	4	30	31	14	79
Seldovia	1	3	0	0	4
Seward	7	21	19	7	54
Soldotna	9	26	24	8	67
TOTAL	37	106	116	53	312
2005					
Homer	18	47	27	11	103
Kenai	10	33	33	14	90
Seldovia	1	6	2	1	10
Seward	12	19	16	7	54
Soldotna	16	40	20	5	81
TOTAL	57	145	98	38	338
2006					
Homer	14	39	25	5	83
Kenai	14	42	43	14	113
Seldovia	1	6	0	1	8
Seward	7	23	19	6	55
Soldotna	5	25	27	7	64
TOTAL	41	135	114	33	323
2007					
Homer	3	40	28	16	87
Kenai	11	43	44	14	112
Seldovia	1	9	7	1	18
Seward	7	11	10	9	37
Soldotna	9	33	22	16	80
TOTAL	31	136	111	56	334

Table 1.45

KPB Construction Permits

KPB Annual Permit VOLUME by TYPE by Quarter - 2001-2007					
	1st Quarter	2nd Quarter	3rd Quarter	4th Quarter	TOTAL
2001					
Residential New	7	45	29	8	89
Residential Alter/Add	13	38	31	14	96
Commercial New	6	9	15	2	32
Commercial Alter/Add	14	36	24	18	92
TOTAL	40	128	99	42	309
2002					
Residential New	12	45	38	9	104
Residential Alter/Add	8	42	49	17	116
Commercial New	5	17	14	7	43
Commercial Alter/Add	12	32	28	16	88
TOTAL	37	136	129	49	351
2003					
Residential New	7	47	28	22	104
Residential Alter/Add	17	33	34	10	94
Commercial New	1	17	17	7	42
Commercial Alter/Add	21	26	26	23	96
TOTAL	46	123	105	62	336
2004					
Residential New	17	34	32	11	94
Residential Alter/Add	5	30	44	17	96
Commercial New	7	11	15	9	42
Commercial Alter/Add	8	31	25	16	80
TOTAL	37	106	116	53	312
2005					
Residential New	18	49	31	13	111
Residential Alter/Add	14	46	36	10	106
Commercial New	6	27	9	4	46
Commercial Alter/Add	19	23	22	11	75
TOTAL	57	145	98	38	338
2006					
Residential New	13	57	48	8	126
Residential Alter/Add	5	40	32	9	86
Commercial New	5	22	9	7	43
Commercial Alter/Add	18	16	25	9	68
TOTAL	41	135	114	33	323
2007					
Residential New	8	59	36	7	110
Residential Alter/Add	8	34	51	26	119
Commercial New	2	17	10	8	37
Commercial Alter/Add	13	26	14	15	68
TOTAL	31	136	111	56	334

Table 1.46

KPB Unemployment Statistics

Unemployment data are acquired from AK DOLW) and are developed through a survey. Survey data are entered into a standardized model used throughout the U.S. with calculations providing four data sets. The estimated total labor force includes all residents willing and able to work, whether or not they are employed. Employment includes all persons who are gainfully employed by establishments that meet requirements for reporting of wages. Unemployment is calculated by subtracting the estimated number of gainfully employed persons from the estimated total labor force. Lastly, the unemployment rate is calculated by dividing the estimate of unemployed persons by the estimated total labor force.

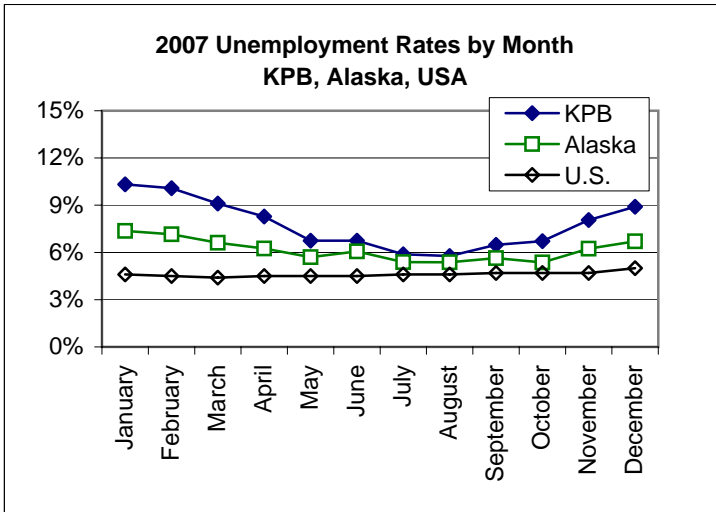

Chart 1.29 illustrates normal relationships between unemployment rates of the U.S., Alaska, and the KPB. Typically, the annual monthly high unemployment rate occurs during January or February. Generally, KPB has the highest rate, followed by Alaska, and the U.S. rate is lowest of the three in this survey driven data set.

Chart 1.29

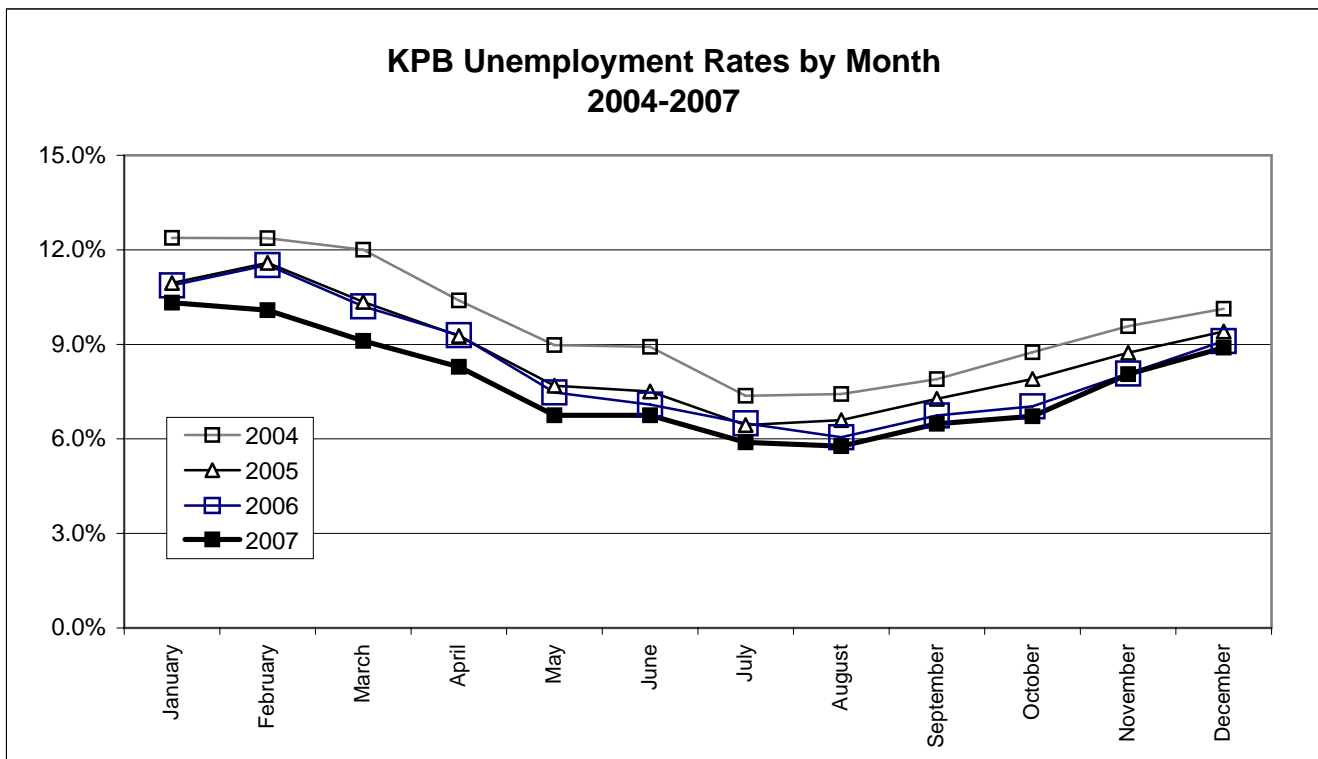

Chart 1.30

KPB Unemployment Statistics

KPB Labor Force by Month - 2000-2007

	Jan	Feb	Mar	Apr	May	Jun	Jul	Aug	Sep	Oct	Nov	Dec	Avg
2000	23,011	23,329	23,290	23,365	24,542	26,598	26,448	26,243	25,160	24,101	24,071	24,174	24,528
2001	23,056	23,003	23,055	23,139	24,195	26,114	26,836	25,619	24,496	23,717	23,656	23,801	24,224
2002	23,659	23,374	23,569	24,173	24,925	25,919	26,796	26,125	24,942	24,317	24,294	24,409	24,709
2003	24,298	24,108	24,243	24,379	25,394	26,781	27,170	26,352	24,571	24,028	23,988	23,875	24,932
2004	23,874	24,000	24,130	24,130	25,302	27,119	27,599	26,342	24,958	24,334	24,116	23,981	24,990
2005	23,977	23,941	24,094	24,081	25,254	26,855	27,547	26,324	24,873	24,309	23,952	23,897	24,925
2006	24,261	24,422	24,254	24,457	25,770	27,205	27,625	27,383	25,518	24,741	24,605	24,773	25,418
2007	24,577	24,659	24,394	24,522	25,835	27,390	27,497	27,399	26,075	24,564	24,678	24,760	25,529
Change	316	237	140	65	65	185	-128	16	557	-177	73	-13	111

Table 1.47

KPB Unemployment by Month - 2000-2007

	Jan	Feb	Mar	Apr	May	Jun	Jul	Aug	Sep	Oct	Nov	Dec	Avg
2000	2,530	2,575	2,445	2,138	1,943	1,843	1,546	1,556	1,496	1,671	1,871	2,019	1,969
2001	2,327	2,379	2,276	2,045	1,767	1,813	1,543	1,560	1,560	1,754	1,965	2,181	1,931
2002	2,503	2,518	2,542	2,335	2,117	2,207	1,981	2,007	2,092	2,247	2,466	2,690	2,309
2003	2,935	3,048	2,795	2,564	2,345	2,542	2,169	2,122	2,126	2,301	2,508	2,636	2,508
2004	2,956	2,969	2,897	2,508	2,272	2,419	2,033	1,956	1,971	2,129	2,309	2,429	2,404
2005	2,625	2,774	2,493	2,231	1,942	2,015	1,773	1,737	1,809	1,921	2,092	2,249	2,138
2006	2,638	2,812	2,475	2,273	1,926	1,929	1,794	1,658	1,721	1,740	1,986	2,256	2,101
2007	2,537	2,487	2,222	2,032	1,743	1,848	1,619	1,581	1,690	1,650	1,988	2,203	1,967
Change	-101	-325	-253	-241	-183	-81	-175	-77	-31	-90	2	-53	-134

Table 1.48

KPB Unemployment Rate by Month - 2000-2007

	Jan	Feb	Mar	Apr	May	Jun	Jul	Aug	Sep	Oct	Nov	Dec	Avg
2000	11.0%	11.0%	10.5%	9.2%	7.9%	6.9%	5.8%	5.9%	5.9%	6.9%	7.8%	8.4%	8.1%
2001	10.1%	10.3%	9.9%	8.8%	7.3%	6.9%	5.7%	6.1%	6.4%	7.4%	8.3%	9.2%	8.0%
2002	10.6%	10.8%	10.8%	9.7%	8.5%	8.5%	7.4%	7.7%	8.4%	9.2%	10.2%	11.0%	9.4%
2003	12.1%	12.6%	11.5%	10.5%	9.2%	9.5%	8.0%	8.1%	8.7%	9.6%	10.5%	11.0%	10.1%
2004	12.4%	12.4%	12.0%	10.4%	9.0%	8.9%	7.4%	7.4%	7.9%	8.7%	9.6%	10.1%	9.7%
2005	10.9%	11.6%	10.3%	9.3%	7.7%	7.5%	6.4%	6.6%	7.3%	7.9%	8.7%	9.4%	8.6%
2006	10.9%	11.5%	10.2%	9.3%	7.5%	7.1%	6.5%	6.1%	6.7%	7.0%	8.1%	9.1%	8.3%
2007	10.3%	10.1%	9.1%	8.3%	6.7%	6.7%	5.9%	5.8%	6.5%	6.7%	8.1%	8.9%	7.8%
Change	-0.6%	-1.4%	-1.1%	-1.0%	-0.7%	-0.3%	-0.6%	-0.3%	-0.3%	-0.3%	0.0%	-0.2%	-0.6%

Table 1.49

KPB Employment by Month - 2000-2007

	Jan	Feb	Mar	Apr	May	Jun	Jul	Aug	Sep	Oct	Nov	Dec	Avg
2000	20,481	20,754	20,845	21,227	22,599	24,755	24,902	24,687	23,664	22,430	22,200	22,155	22,558
2001	20,729	20,624	20,779	21,094	22,428	24,301	25,293	24,059	22,936	21,963	21,691	21,620	22,293
2002	21,156	20,856	21,027	21,838	22,808	23,712	24,815	24,118	22,850	22,070	21,828	21,719	22,400
2003	21,363	21,060	21,448	21,815	23,049	24,239	25,001	24,230	22,445	21,727	21,480	21,239	22,425
2004	20,918	21,031	21,233	21,622	23,030	24,700	25,566	24,386	22,987	22,205	21,807	21,552	22,586
2005	21,352	21,167	21,601	21,850	23,312	24,840	25,774	24,587	23,064	22,388	21,860	21,648	22,787
2006	21,623	21,610	21,779	22,184	23,844	25,276	25,831	25,725	23,797	23,001	22,619	22,517	23,317
2007	22,040	22,172	22,172	22,490	24,092	25,542	25,878	25,818	24,385	22,914	22,690	22,557	23,563
Change	417	562	393	306	248	266	47	93	588	-87	71	40	245

Table 1.50

KPB Demographics

Census 2000

KPB population counts are conducted by the United States Census Bureau every ten years. Check out their website (<http://www.census.gov/>), which has two excellent data options - QuickFacts and AmericanFactFinder.

Census data is collected for two general types of area: incorporated cities and Census Designated Places (CDP). KPB incorporated cities include Homer, Kachemak City, Kenai, Seldovia, Seward and Soldotna. A CDP is delineated by geographic features such as rivers, roads, or ridges. Defining characteristics include:

- * A sense of community;
- * A population of 25 or more; and
- * It must have been recognized as possibly fitting the criteria four years prior to the census, as planning began.

The Census Bureau considers an incorporated city with a population greater than 2,500 to be urban, of which there are four in the KPB: Homer, Kenai, Seward and Soldotna. Kenai is ranked 6th largest city in Alaska, Homer ranks 14th, and Soldotna is the 15th largest as of Census 2000 .

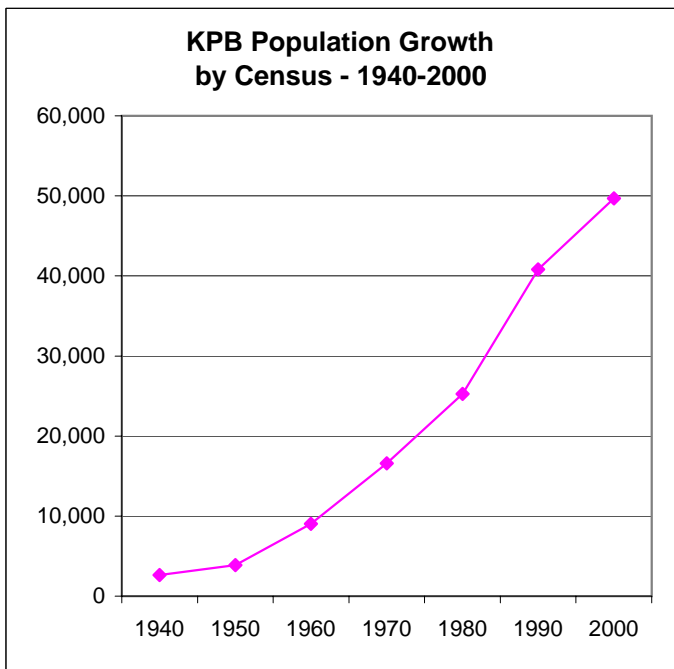

Chart 1.31

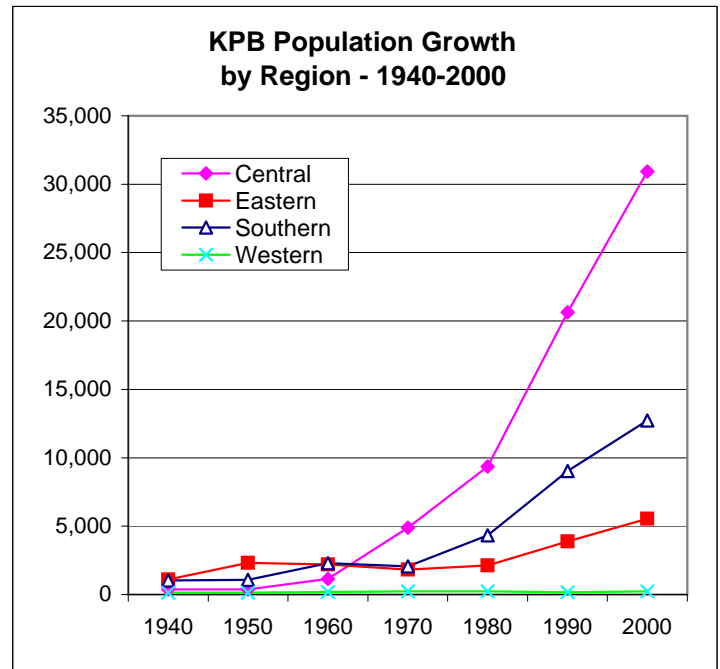

Chart 1.32

Population Estimates

The AK DOLWD prepares annual population estimates for Alaska. Estimates include Armed Forces members serving in Alaska but exclude seasonal populations. Primary indicators for population change include Alaska Permanent Fund Dividend data, vital statistics, and survey information. Although estimates are identified for July 1, data represents annual average resident population rather than a specific date.

These revised, current estimates are consistent with U.S. Census Bureau statewide total population estimates and supersede all previously published estimates.

<http://almis.labor.state.ak.us/?PAGEID=67&SUBID=171>

KPB Demographics

KPB CDP's - Census 2000, Population Estimates - 2001 - 2007 (Revised-2/15/08)									
KPB Community	2000 Census	June 1 Estimate (Subject to Annual Revision)							Annual Change
		2001	2002	2003	2004	2005	2006	2007***	
Anchor Point	1,845	1,809	1,780	1,809	1,829	1,753	1,803	1,814	2.9%
Bear Creek	1,748	1,836	1,833	1,829	1,904	1,898	1,922	1,945	1.3%
Beluga	32	24	25	27	26	21	21	19	0.0%
Clam Gulch	173	168	173	176	163	171	165	175	-3.5%
Cohoe	1,168	1,175	1,211	1,208	1,321	1,282	1,260	1,263	-1.7%
Cooper Landing	369	389	370	351	345	343	357	353	4.1%
Crown Point	75	89	88	82	90	82	81	74	-1.2%
Diamond Ridge*	1,802	1,835	412	314	769	743	690	733	-7.1%
Fox River	616	594	576	582	613	627	639	643	1.9%
Fritz Creek	1,603	1,663	1,733	1,742	1,731	1,761	1,723	1,757	-2.2%
Funny River	636	624	687	707	736	746	729	747	-2.3%
Halibut Cove	35	29	28	27	26	23	24	20	4.3%
Happy Valley	489	505	521	505	528	483	472	495	-2.3%
Homer*	3,946	4,070	5,535	5,877	5,350	5,394	5,454	5,502	1.1%
Hope	137	145	152	161	165	141	143	147	1.4%
Kachemak	431	426	433	478	470	460	458	467	-0.4%
Kalifornsky	5,846	6,017	6,159	6,248	6,638	6,825	6,914	7,129	1.3%
Kasilof	471	452	501	559	473	509	547	596	7.5%
Kenai	6,942	6,889	7,076	7,129	6,839	6,768	6,864	6,971	1.4%
Lowell Point	92	96	108	89	76	96	76	85	-20.8%
Miller Landing*	74	70	Annexed into Homer						
Moose Pass	206	206	217	219	220	217	204	201	-6.0%
Nanwalek	177	184	219	214	204	219	228	217	4.1%
Nikiski	4,327	4,363	4,362	4,351	4,289	4,190	4,179	4,345	-0.3%
Nikolaevsk	345	345	334	315	309	305	297	297	-2.6%
Ninilchik	772	760	762	774	786	786	784	778	-0.3%
Port Graham	171	178	174	165	153	128	136	134	6.3%
Primrose	93	99	92	87	91	84	79	78	-6.0%
Ridgeway	1,932	1,962	1,968	2,020	2,058	2,060	1,961	1,987	-4.8%
Salamatof	954	912	915	923	920	911	906	878	-0.5%
Seldovia**	430	435	449	430	423	390	379	429	-2.8%
Seldovia City**	286	287	288	279	264	240	220	268	-8.3%
Seldovia Village**	144	148	161	151	159	150	159	161	6.0%
Seward	2,830	2,759	2,755	2,744	2,542	2,595	2,627	2,661	1.2%
Soldotna	3,759	3,793	3,851	4,001	3,776	3,794	3,807	3,982	0.3%
Sterling	4,705	4,756	4,780	4,878	4,919	4,980	5,036	5,123	1.1%
Sunrise	18	16	14	15	19	24	22	20	-8.3%
Tyonek	193	161	181	192	185	199	199	181	0.0%
Remainder Kenai/Cook Inlet		229	187	195	189	168	153	118	-8.9%
Remainder Seward census sub area		23	13	23	18	15	11	6	-26.7%
Remainder of KPB	249								
Kenai Peninsula	49,691	50,086	50,674	51,446	51,193	51,191	51,350	52,370	0.3%

Table 1.51

* - Homer annexation included all of Miller Landing CDP and part of Diamond Ridge CDP. Annexation was effective April 1, 2002.

** - Seldovia City plus Seldovia Village is not equal to the Seldovia CDP.

*** - 2007 estimates are preliminary.

Note - All Estimates since 2000 have been revised by the State of Alaska Department of Labor and Workforce Development.

Source - <http://www.labor.state.ak.us/research/pop/estimates/04t4-3.xls>

KPB Demographics

KPB Census by City/CDP - 1940-2000									
KPB Community	Region	1940	1950	1960	1970	1980	1990	2000	
Anchor Point	S	20	65	171	102	226	866	1,845	
Bear Creek	E	0	0	0	0	0	580	1,748	
Beluga	W	New CDP - Census 2000							32
Clam Gulch	C	0	0	0	47	50	79	173	
Cohoe	C	0	0	122	0	0	508	1,168	
Cooper Landing	E	0	60	88	31	116	243	369	
Crown Point	E	0	0	0	0	0	62	75	
Diamond Ridge	S	New CDP - Census 2000							1,802
Fox River	S	0	0	0	0	0	382	616	
Fritz Creek	S	0	0	0	27	302	1,426	1,603	
Funny River	C	New CDP - Census 2000							636
Halibut Cove	S	0	0	25	44	47	78	35	
Happy Valley	S	0	0	0	0	0	309	489	
Homer	S	325	307	1,247	1,083	2,209	3,660	3,946	
Hope	E	71	63	44	51	103	161	137	
Jakalof Bay	S	New CDP - 1980, Deleted - Census 2000					36	28	Deleted
Kachemak	S	0	0	0	76	403	365	431	
Kalifornsky	C	0	0	0	0	92	285	5,846	
Kasilof	C	62	62	89	71	201	383	471	
Kenai	C	303	321	778	3,533	4,324	6,327	6,942	
Lowell Point	E	New CDP - Census 2000							92
Miller Landing	S	New CDP - Census 2000							74
Moose Pass	E	84	70	136	53	76	81	206	
Nanwalek	S	48	75	78	58	124	158	177	
Nikiski	C		0	0	0	1,109	2,743	4,327	
Nikolaevsk	S	0	0	0	0	0	371	345	
Ninilchik	S	132	97	169	134	341	456	772	
Port Graham	S	93	92	139	107	161	166	171	
Primrose	E	0	0	0	0	0	63	93	
Ridgeway	C	0	0	0	0	0	2,018	1,932	
Salamatof	C	0	0	0	0	334	999	954	
Seldovia City	S	410	437	460	437	479	316	286	
Seward	E	949	2,114	1,891	1,587	1,843	2,699	2,830	
Soldotna	C	0	0	32	1,202	2,320	3,482	3,759	
Sterling	C	0	0	115	30	919	3,802	4,705	
Sunrise	C	New CDP - Census 2000							18
Tyonek	W	136	132	187	232	239	154	193	
Remainder of census area	E		946	3,282	7,681	16,116	7,409	249	
Kenai Peninsula Borough		2,633	4,831	9,053	16,586	25,282	40,802	49,691	

Table 1.52

KPB Demographics

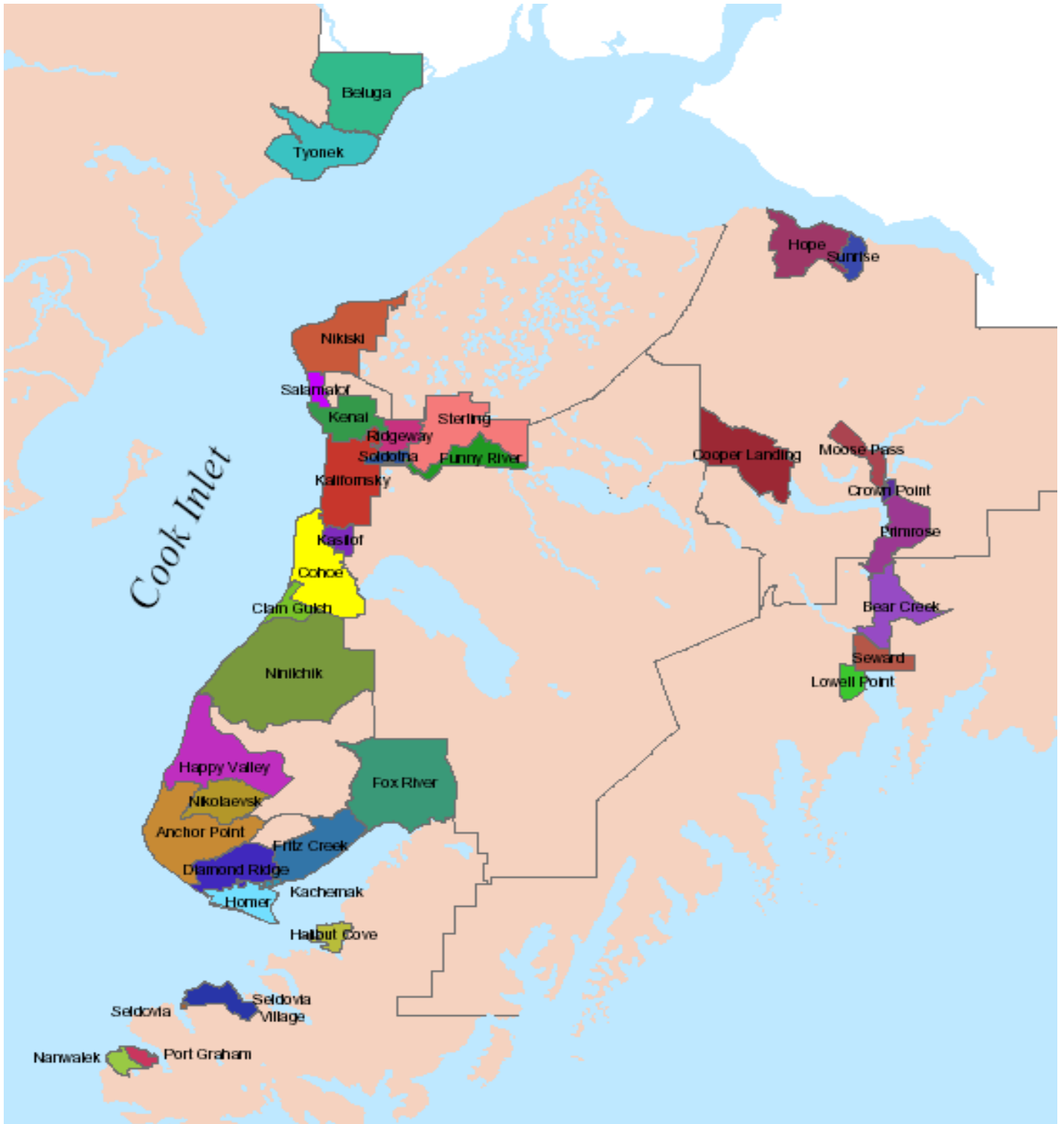

KENAI PENINSULA BOROUGH CENSUS DESIGNATED PLACES

Chart 1.33

KPB Demographics

KPB Population by Age Group - 1990 v 2000 v 2006

	1990	2000	2006	Percent Change-2000, 2006	Percent of Total 2006 Population
Total Population	40,802	49,691	51,350	3.3%	100.00%
Under 5 years	3,862	3,288	3,107	-5.5%	6.4%
5 to 9 years	4,059	4,024	3,414	-15.2%	7.8%
10 to 14 years	3,516	4,698	3,974	-15.4%	9.1%
15 to 19 years	2,970	4,140	4,399	6.3%	8.1%
20 to 24 years	2,081	2,132	2,770	29.9%	4.2%
25 to 34 years	7,348	5,648	4,993	-11.6%	11.0%
35 to 44 years	8,234	9,074	7,126	-21.5%	17.7%
45 to 54 years	4,205	8,739	9,972	14.1%	17.0%
55 to 59 years	1,376	2,632	4,027	53.0%	5.1%
60 to 64 years	1,164	1,667	2,752	65.1%	3.2%
65 to 74 years	1,489	2,361	2,972	25.9%	4.6%
75 to 84 years	419	1,077	1,442	33.9%	2.1%
85 years and over	79	211	402	90.5%	0.4%

KPB's median age increased from 31.1 years during 1990 to 36.3 as of Census 2000. Alaska's median age was 32.4 years while the U.S. was 35.3 years, per Census 2000. The KPB 2006 median age is estimated at 39.7 years.

KPB's 2006 population, estimated by the AK DOL&WD stands at 51,350, a 0.2% increase over 2005, based primarily on births, deaths and Permanent Fund Dividend applications.

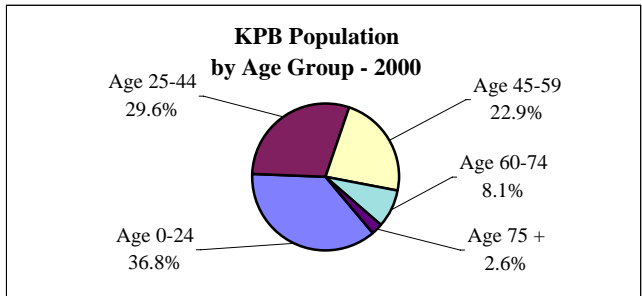

Chart 1.34

KPB Population by Age Group - 1990, 2000, 2006

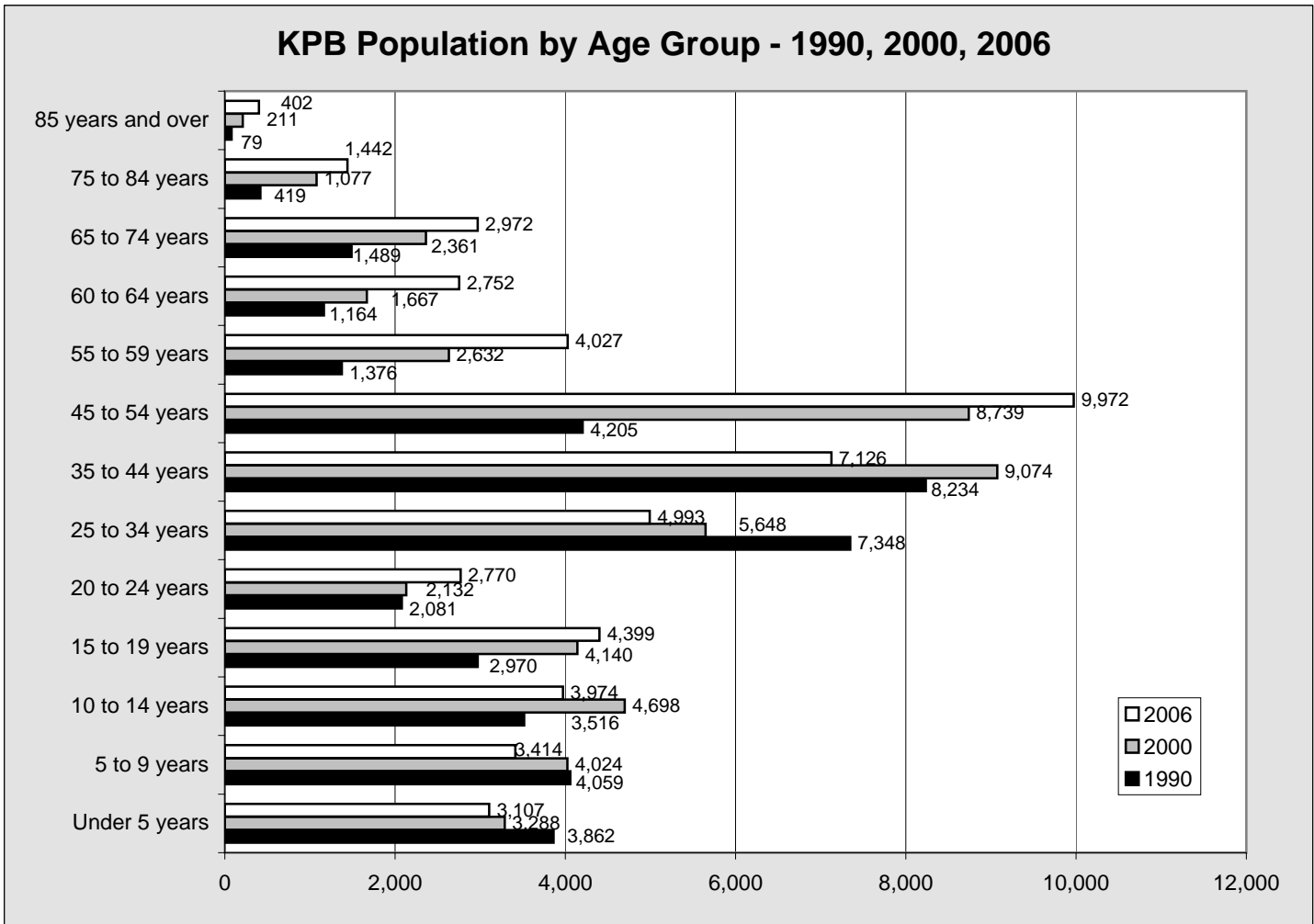

Chart 1.35

KPB Demographics

Percentage Change of Population By Age Cohort - 2000-2006						
Age	Kenai Peninsula Borough	Municipality of Anchorage	Fairbanks Northstar Borough	Juneau Borough	Matanuska-Susitna Borough	State of Alaska
0-4	-5.5%	15.6%	14.7%	-5.9%	37.4%	10.2%
5-9	-15.2%	1.4%	1.7%	-19.0%	13.4%	-2.8%
10-14	-15.4%	3.8%	-4.4%	-13.1%	11.5%	-2.9%
15-19	6.3%	13.6%	3.0%	6.5%	28.5%	12.0%
20-24	29.9%	20.9%	-6.6%	2.7%	62.0%	13.7%
25-29	-13.4%	2.1%	-5.2%	-17.4%	35.1%	-1.7%
30-34	-10.0%	0.6%	6.2%	-21.1%	23.7%	-3.1%
35-39	-22.1%	-11.5%	-8.6%	-19.9%	2.3%	-14.0%
40-44	-20.9%	-8.6%	-5.2%	-11.9%	2.1%	-9.5%
45-49	-2.5%	4.2%	2.7%	-2.5%	25.2%	4.4%
50-54	36.4%	20.2%	26.1%	19.5%	70.1%	26.0%
55-59	53.0%	46.5%	59.6%	67.4%	80.2%	50.5%
60-64	65.1%	47.8%	57.0%	52.7%	77.2%	50.8%
65-69	33.7%	25.1%	34.1%	47.6%	47.8%	30.8%
70-74	16.2%	9.9%	12.8%	2.2%	34.4%	12.1%
75-79	19.8%	14.5%	21.9%	18.5%	57.1%	20.9%
80-84	64.2%	41.7%	25.9%	18.1%	83.0%	43.0%
85-90	106.9%	54.1%	47.9%	57.4%	100.0%	52.0%
90+	63.8%	74.1%	87.4%	79.6%	142.4%	80.6%
Overall Change	3.30%	8.70%	6.00%	0.20%	30.10%	6.9%
Median Age						
2000	36.3	32.4	29.5	35.3	34.1	32.4
2006	39.7	32.4	31.2	38.8	34.9	33.5

Table 1.54

Note that from 2000 to 2006, three of the five boroughs illustrated experienced a population decrease in the 10-14 year age group, while four of the five areas experienced population decline in the 35-44 year age group.

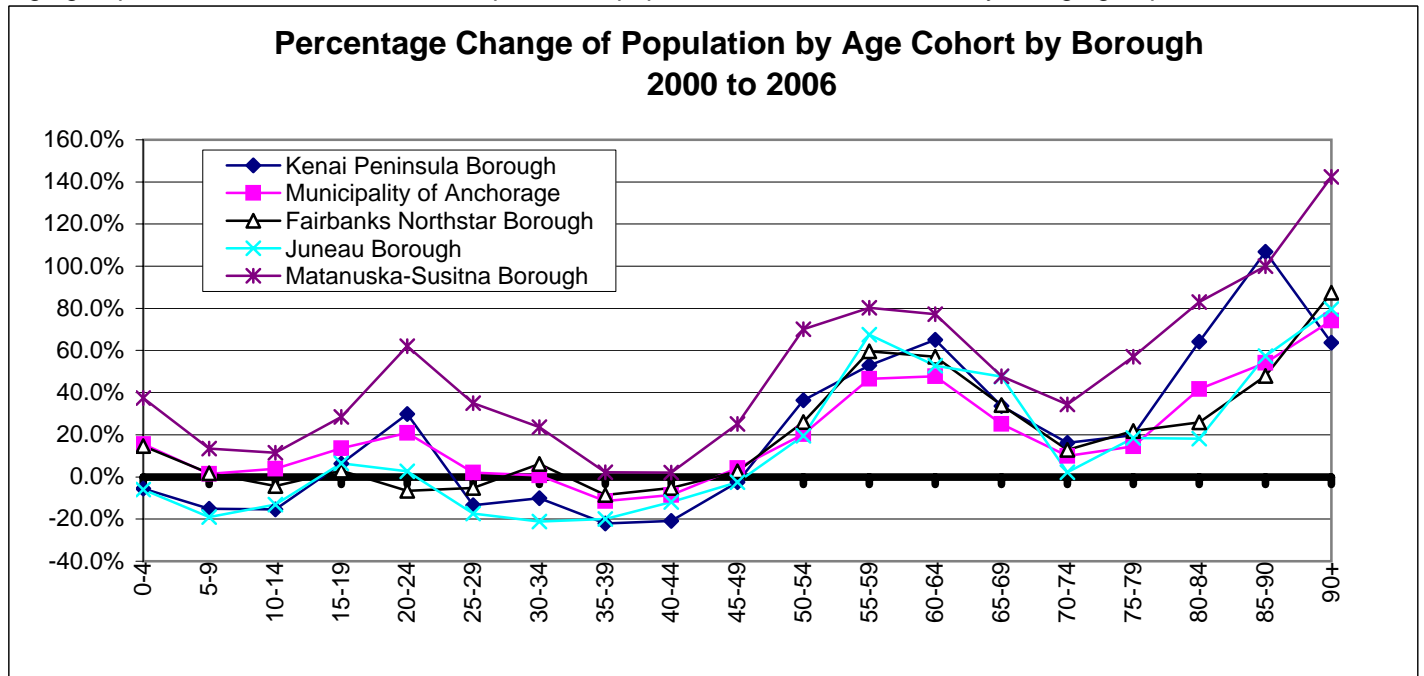

Chart 1.36

KPB Demographics

KPB Select Detail - 1990 v 2000									
Population (2006 estimate - 51,350)					Housing				
	1990	2000	Percent Change	Percent of Total		1990	2000	Percent Change	Percent of Total
Total Population	40,802	49,691	21.8%	100.0%	Total Households	14,250	18,438	29.4%	100.0%
Male	21,606	25,853	19.7%	52.0%	Family Households	10,216	12,716	24.5%	69.0%
Female	19,196	23,838	24.2%	48.0%	With Children Under 18		7,003	NA	38.0%
Under 5 years	3,795	3,288	-13.4%	6.6%	Married Couple Family	8,456	10,218	20.8%	55.4%
5 to 9 years	4,104	4,024	-1.9%	8.1%	With Own Children Under 18		5,133	NA	27.8%
10 to 14 years	3,505	4,698	34.0%	9.5%	Female Householder, no husband present		1,654	NA	9.0%
15 to 19 years	2,939	4,140	40.9%	8.3%	With Own Children Under 18		1,276	NA	6.9%
20 to 24 years	2,086	2,132	2.2%	4.3%	Average Household Size	2.79	2.62	-6.1%	0.0%
25 to 34 years	7,281	5,648	-22.4%	11.4%	Average Family Size		3.15	NA	0.0%
35 to 44 years	8,229	9,074	10.3%	18.3%	Total Housing Units	19,364	24,871	NA	100.0%
45 to 54 years	4,280	8,739	104.2%	17.6%	Occupied Housing Units	14,250	18,438	29.4%	74.1%
55 to 59 years	1,387	2,632	89.8%	5.3%	Vacant Housing Units	5,114	6,433	25.8%	25.9%
60 to 64 years	1,181	1,667	41.2%	3.4%	Seasonal, Recreational, Occasional Use	2,819	4,560	61.8%	18.3%
65 to 74 years	1,503	2,361	57.1%	4.8%	Owner Vacancy Rate	4.1%	2.9%	NA	NA
75 to 84 years	431	1,077	149.9%	2.2%	Rental Vacancy Rate	13.9%	14.4%	NA	NA
85 years and over	81	211	160.5%	0.4%	Owner Occupied Units	9,677	13,585	40.4%	54.6%
Median Age	31.1	36.3	16.7%	NA	Renter Occupied Units	4,573	4,853	6.1%	19.5%
18 Years and Over	13,396	34,832	160.0%	70.1%	Marital Status (over 15)		37,696	NA	100.0%
Male		18,239	NA	NA	Never married		8,829	NA	23.4%
Female		16,593	NA	NA	Married except separated		22,022	NA	58.4%
65 Years and Over	2,015	3,649	81.1%	7.3%	Separated		698	NA	1.9%
Male		1,765	NA	NA	Widowed		1,330	NA	3.5%
Female		1,884	NA	NA	Divorced		4,817	NA	12.8%
Place of Birth					Disabled, Noninstitutionalized				
U.S. Native	39,726	48,335	21.7%	97.3%	Population 5 to 20		13,244	NA	100.0%
Born in Alaska		17,440	NA	35.1%	With a Disability		842	NA	6.4%
Born in other state		30,444	NA	61.3%	Population 21 to 64		28,547	NA	100.0%
Foreign Born	1,076	1,356	26.0%	2.7%	With a Disability		4,843	NA	17.0%
Naturalized Citizen		872	NA	1.8%	Percent Employed		45.4%	NA	45.4%
Not a Citizen		484	NA	1.0%	Without a Disability		23,704	NA	83.0%
Veteran Status					Income in 1999 - Families				
Civilian veterans	5,335	5,941	11.4%	17.1%	Total		12,736		
Educational Attainment					Less than \$10,000	604	602	-0.3%	4.7%
Population 25 years and over				31,388	\$10,000 - \$14,999	548	512	-6.6%	4.0%
Less than 9th grade	934	985	5.5%	3.1%	\$15,000 - \$24,999	1,177	1,248	6.0%	9.8%
9th-12th, no diploma	2,185	2,620	19.9%	8.3%	\$25,000 - \$34,999	1,151	1,396	21.3%	11.0%
High School Diploma	8,560	9,990	16.7%	31.8%	\$35,000 - \$49,999	1,895	1,970	4.0%	15.5%
College, no degree	6,581	9,492	44.2%	30.2%	\$50,000 - \$74,999	2,688	3,148	17.1%	24.7%
Associate Degree	1,789	1,939	8.4%	6.2%	\$75,000 - \$99,999	1,361	1,855	36.3%	14.6%
Bachelor's Degree	3,165	4,254	34.4%	13.6%	\$100,000 - \$149,999	687	1,561	127.2%	12.3%
Graduate, Profess Degr	1,209	2,108	74.4%	6.7%	\$150,000 - \$199,999	279	245	-12.2%	1.9%
Percent HS Grad	87.2%	88.5%	1.5%	NA	\$200,000 or more	NA	199	NA	1.6%
Percent Bachelor's +	17.9%	20.3%	13.4%	NA	Median Income - \$	48,339	54,106	11.9%	NA

Table 1.55

Homer Sales

Homer Annual Gross Sales by Quarter - in \$

	1st Quarter	2nd Quarter	3rd Quarter	4th Quarter	Total	Annual Change
1991	23,964,674	40,562,770	46,872,982	27,327,535	138,727,961	
1992	22,773,520	37,666,653	47,296,221	32,559,151	140,295,545	1.1%
1993	24,762,542	43,361,848	50,615,555	32,346,737	151,086,682	7.7%
1994	31,235,061	42,700,947	58,938,940	38,217,421	171,092,369	13.2%
1995	32,193,561	48,092,891	66,559,556	50,757,887	197,603,895	15.5%
1996	40,009,169	53,691,216	60,425,514	45,004,959	199,130,858	0.8%
1997	39,502,354	55,496,297	62,490,851	45,710,368	203,199,870	2.0%
1998	41,054,484	53,702,365	70,886,151	46,799,617	212,442,617	4.5%
1999	39,553,648	53,871,188	66,353,121	44,064,518	203,842,475	-4.0%
2000	38,455,167	59,287,582	70,009,668	48,229,307	215,981,724	6.0%
2001	40,844,978	56,857,475	77,453,956	54,547,098	229,703,507	6.4%
2002*	44,269,653	68,675,179	89,708,860	60,586,992	263,240,684	14.6%
2003	51,228,276	75,287,944	87,226,845	60,330,717	274,073,782	4.1%
2004	48,141,586	75,752,214	93,892,260	72,595,789	290,381,849	6.0%
2005	51,881,645	86,186,468	101,485,822	70,599,184	310,153,119	6.8%
2006	56,187,494	89,331,199	118,504,783	92,240,932	356,264,408	14.9%
2007	61,416,940	97,343,260	113,704,551	76,234,220	348,698,971	-2.1%
Change	9.3%	9.0%	-4.1%	-17.4%	-2.1%	

Table 2.1

* - Effective April 1, 2002, Homer annexed an area that increased it's area by 28%.

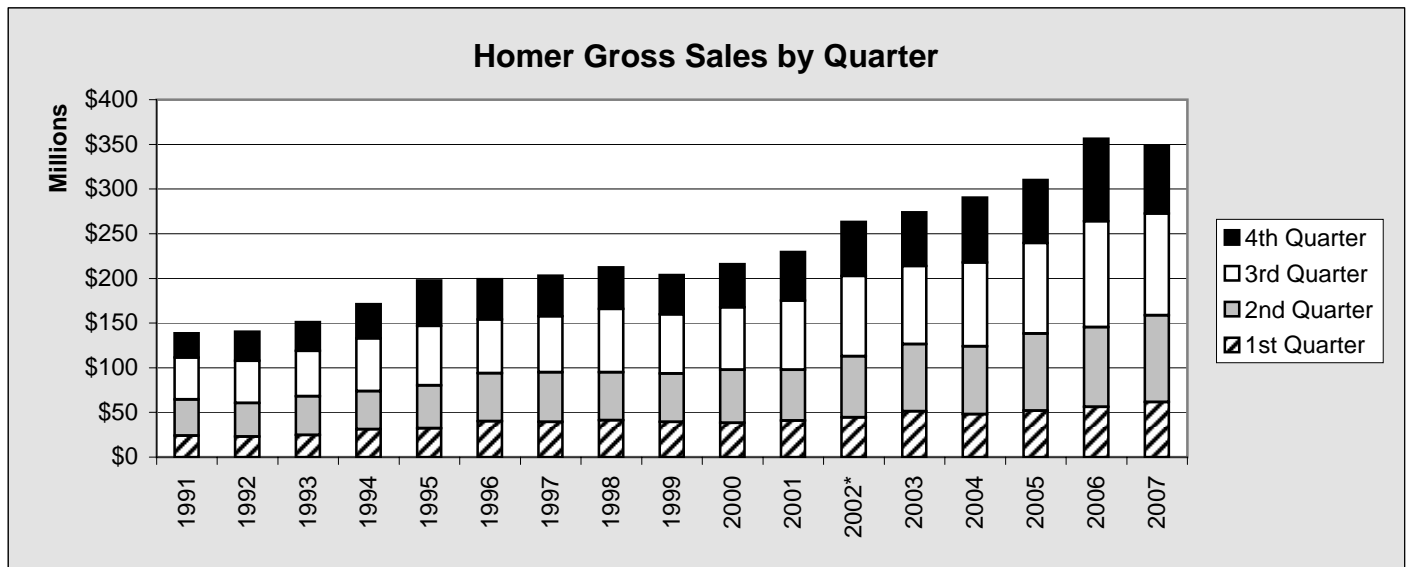

Chart 2.1

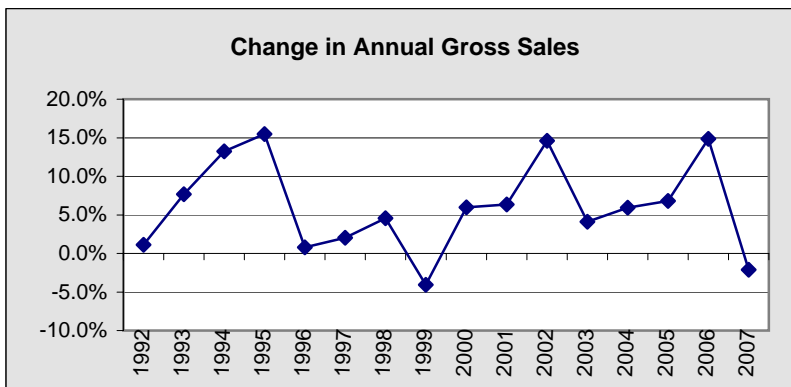

Chart 2.2

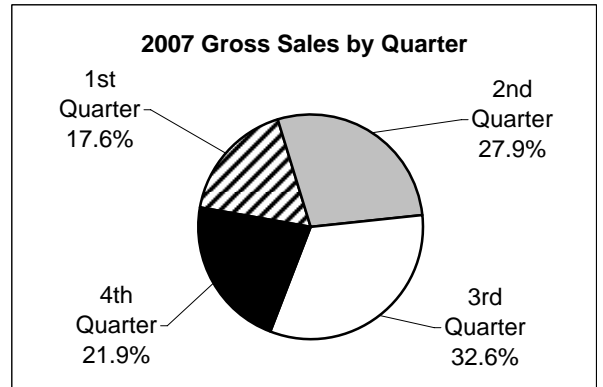

Chart 2.3

Homer Sales

Homer Annual Taxable Sales by Quarter - in \$						
	1st Quarter	2nd Quarter	3rd Quarter	4th Quarter	Total	Annual Change
1991	12,735,760	21,963,602	26,637,684	14,639,934	75,976,980	
1992	12,518,704	22,132,230	27,735,962	16,006,556	78,393,452	3.2%
1993	13,461,637	23,587,289	29,152,888	16,057,090	82,258,904	4.9%
1994	14,062,259	23,814,227	29,434,329	16,734,643	84,045,458	2.2%
1995	14,797,530	24,901,076	30,398,162	18,098,624	88,195,392	4.9%
1996	15,811,688	25,240,189	30,539,871	18,335,650	89,927,398	2.0%
1997	16,213,730	25,960,313	31,654,939	19,496,943	93,325,925	3.8%
1998	16,418,580	26,366,097	32,103,748	19,552,917	94,441,342	1.2%
1999	16,638,467	26,938,559	34,247,729	20,323,983	98,148,738	3.9%
2000	17,327,860	28,797,872	35,677,211	21,387,173	103,190,116	5.1%
2001	17,765,204	30,191,477	37,574,702	21,780,156	107,311,539	4.0%
2002*	18,699,958	34,270,923	43,258,197	25,063,470	121,292,548	13.0%
2003	22,456,282	37,038,468	45,127,086	27,107,360	131,729,196	8.6%
2004	23,824,920	39,648,524	48,969,328	27,490,906	139,933,678	6.2%
2005	24,333,243	41,492,825	51,146,949	28,688,087	145,661,104	4.1%
2006	25,736,748	43,394,135	53,771,924	30,399,083	153,301,890	5.2%
2007	27,254,042	47,215,996	59,406,793	30,408,885	164,285,716	7.2%
Change	5.9%	8.8%	10.5%	0.03%	7.2%	

Table 2.2 * - Effective April 1, 2002, Homer annexed an area that increased it's area by 28%.

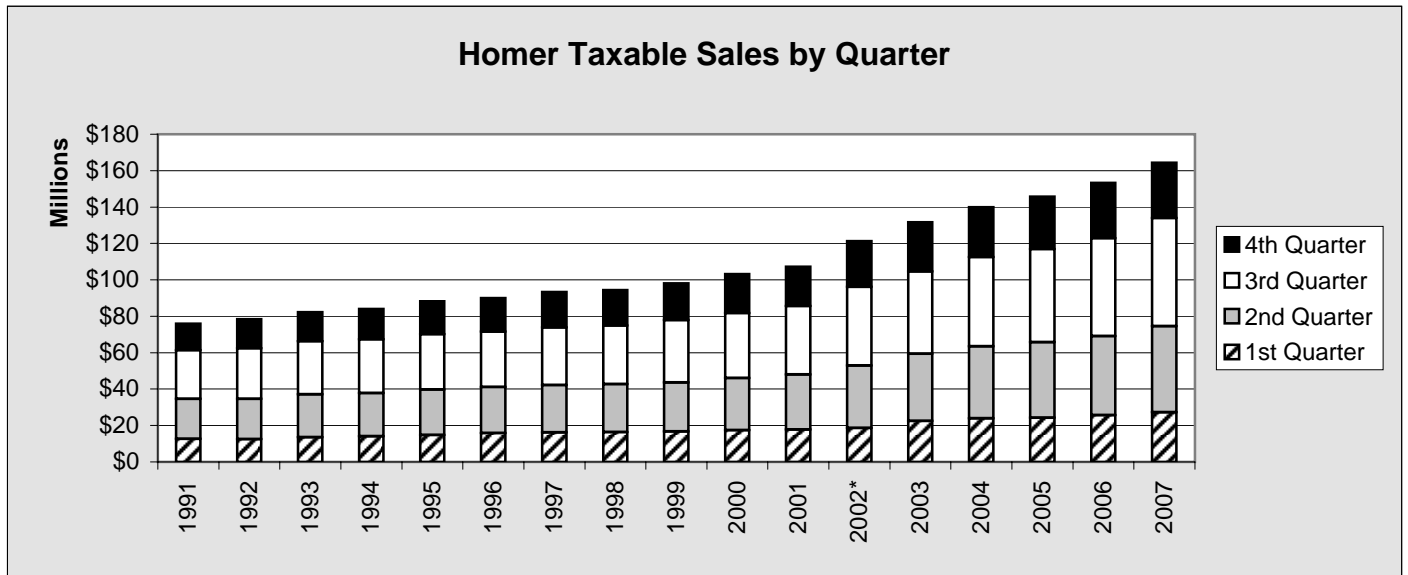

Chart 2.4

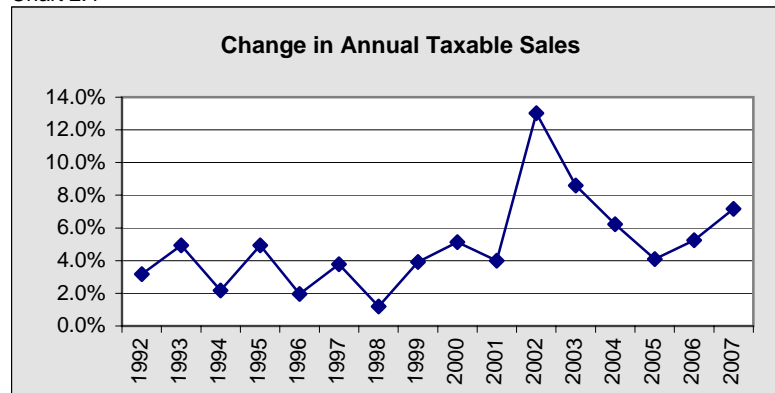

Chart 2.5

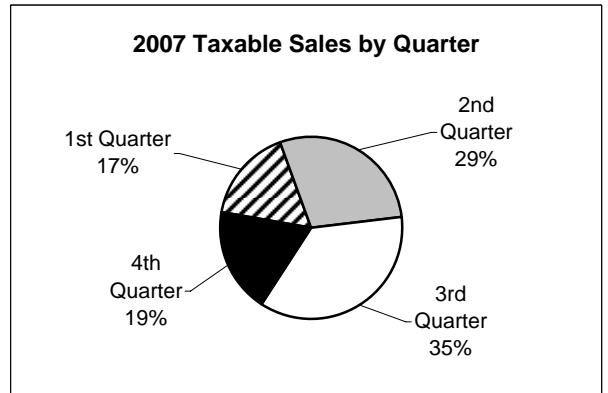

Chart 2.6

Homer Sales

Homer Annual Nontaxable Sales by Quarter - in \$

	1st Quarter	2nd Quarter	3rd Quarter	4th Quarter	Total	Annual Change
1991	11,228,914	18,599,168	20,235,298	12,687,601	62,750,981	
1992	10,254,816	15,534,423	19,560,259	16,552,595	61,902,093	-1.4%
1993	11,300,905	19,774,559	21,462,667	16,289,647	68,827,778	11.2%
1994	17,172,802	18,886,720	29,504,611	21,482,778	87,046,911	26.5%
1995	17,396,031	23,191,815	36,161,394	32,659,263	109,408,503	25.7%
1996	24,197,481	28,451,027	29,885,643	26,669,309	109,203,460	-0.2%
1997	23,288,624	29,535,984	30,835,912	26,213,425	109,873,945	0.6%
1998	24,635,904	27,336,268	38,782,403	27,246,700	118,001,275	7.4%
1999	22,915,181	26,932,629	32,105,392	23,740,535	105,693,737	-10.4%
2000	21,127,307	30,489,710	34,332,457	26,842,134	112,791,608	6.7%
2001	23,079,774	26,665,998	39,879,254	32,766,942	122,391,968	8.5%
2002*	25,569,695	34,404,256	46,450,663	35,523,522	141,948,136	16.0%
2003	28,771,994	38,249,476	42,099,759	33,223,357	142,344,586	0.3%
2004	24,316,666	36,103,690	44,922,932	45,104,883	150,448,171	5.7%
2005	27,548,402	44,693,643	50,338,873	41,911,097	164,492,015	9.3%
2006	30,450,746	45,937,064	64,732,859	61,841,849	202,962,518	23.4%
2007	34,162,898	50,127,264	54,297,758	45,825,335	184,413,255	-9.1%
Change	12.2%	9.1%	-16.1%	-25.9%	-9.1%	

Table 2.3

* - Effective April 1, 2002, Homer annexed an area that increased it's area by 28%.

Homer Nontaxable Sales by Quarter

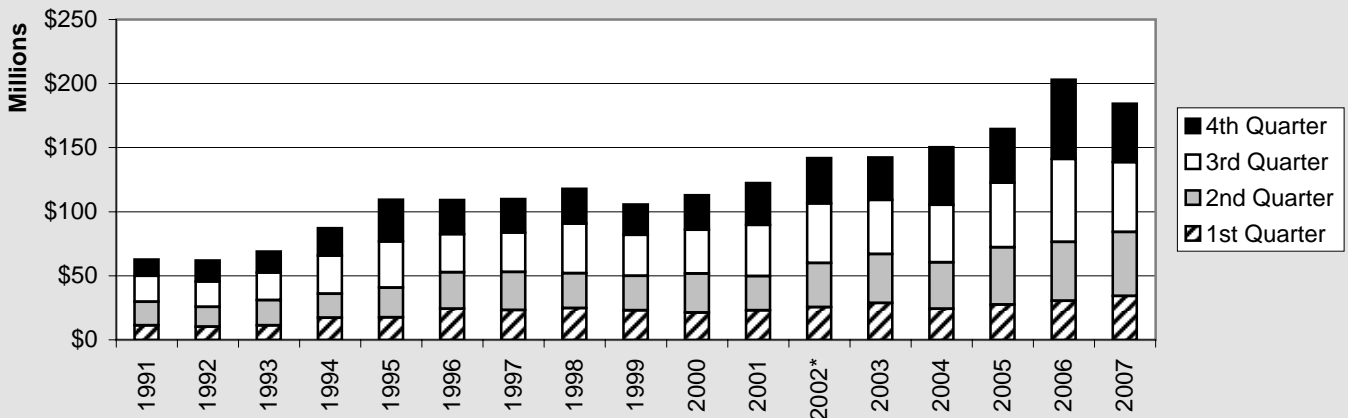

Chart 2.7

Change in Annual Nontaxable Sales

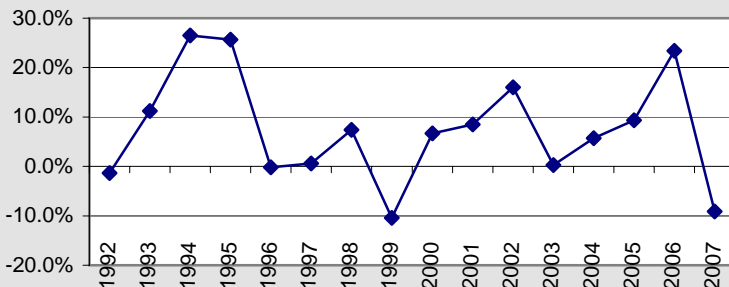

Chart 2.8

2007 Nontaxable Sales by Quarter

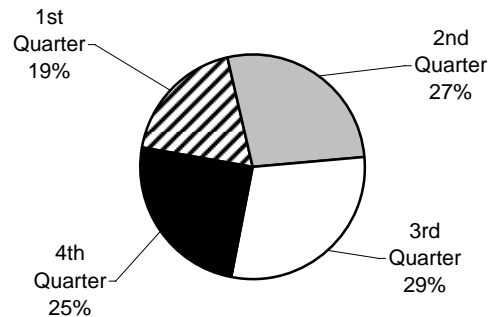

Chart 2.9

Homer Sales

Homer 4th Quarter GROSS Sales by Line of Business - 2002-2007 - in \$								
LOB	2002	2003	2004	2005	2006	2007	Annual Percent Change	Annual Amount Change
RSRC	308,748	510,715	330,586	83,800	72,875	1,443,779	1881.2%	1,370,904
SALES	18,490,191	19,781,614	20,307,300	20,735,281	22,670,583	23,124,074	2.0%	453,491
CONST	13,606,124	8,952,595	12,899,952	8,768,009	21,431,598	9,247,722	-56.9%	-12,183,876
PROP	2,848,171	3,108,450	3,885,507	3,386,349	3,632,064	3,649,901	0.5%	17,837
TOUR	3,007,269	3,344,634	3,442,738	3,464,244	3,644,097	2,948,055	-19.1%	-696,042
SERV	4,958,392	5,311,009	5,833,273	6,483,871	7,893,057	7,792,651	-1.3%	-100,406
PROF	2,425,288	3,049,844	3,712,248	3,082,232	2,936,323	2,514,405	-14.4%	-421,918
UTIL	7,103,426	6,699,963	8,065,919	8,833,640	12,043,125	11,157,408	-7.4%	-885,717
MANU	691,193	946,918	712,931	1,196,678	1,386,764	1,482,190	6.9%	95,426
TRAN	1,166,600	1,072,891	1,896,612	1,382,163	1,860,475	3,530,396	89.8%	1,669,921
WHLS	5,294,430	6,806,757	10,759,077	12,405,671	13,847,704	8,457,822	-38.9%	-5,389,882
GOV	687,160	745,327	749,646	777,246	822,267	885,817	7.7%	63,550
TOTAL	60,586,992	60,330,717	72,595,789	70,599,184	92,240,932	76,234,220	-17.4%	-16,006,712

Table 2.4

For complete listing of Lines of Business, see page 13

Homer 4th Quarter GROSS Sales History	
2002	60,586,992
2003	60,330,717
2004	72,595,789
2005	70,599,184
2006	92,240,932
2007	76,234,220

Table 2.5

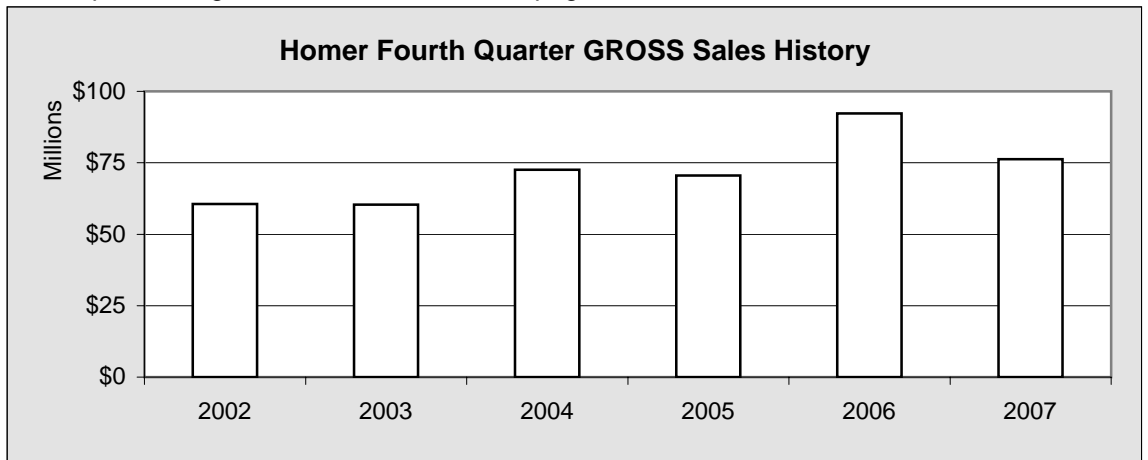

Chart 2.10

Homer Five Year Change 4th Quarter GROSS Sales		
LOB	2002	2007
RSRC	308,748	1,443,779
SALES	18,490,191	23,124,074
CONST	13,606,124	9,247,722
PROP	2,848,171	3,649,901
TOUR	3,007,269	2,948,055
SERV	4,958,392	7,792,651
PROF	2,425,288	2,514,405
UTIL	7,103,426	11,157,408
MANU	691,193	1,482,190
TRAN	1,166,600	3,530,396
WHLS	5,294,430	8,457,822
GOV	687,160	885,817

Table 2.6

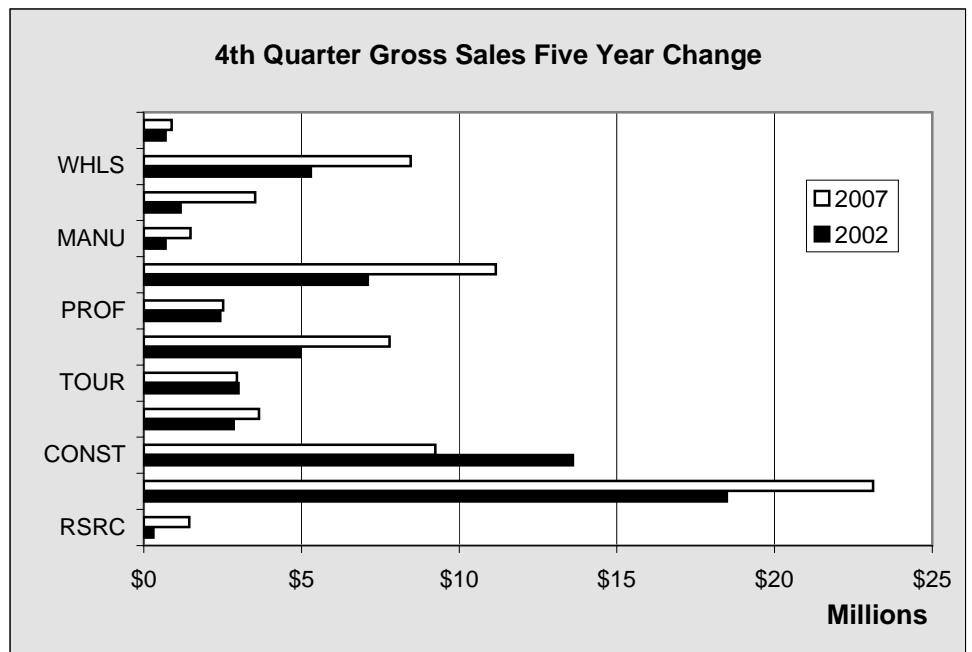

Chart 2.11

Homer Sales

Homer 4th Quarter TAXABLE Sales by Line of Business - 2002-2007 - in \$								
LOB	2002	2003	2004	2005	2006	2007	Annual Percent Change	Annual Amount Change
RSRC	13,191	13,748	25,100	19,799	13,179	22,511	70.8%	9,332
SALES	13,012,862	14,089,655	14,029,845	14,354,481	15,390,218	15,376,256	-0.1%	-13,962
CONST	294,548	267,256	239,390	242,172	268,610	282,788	5.3%	14,178
PROP	1,373,549	1,311,981	1,348,882	1,332,183	1,350,551	1,402,777	3.9%	52,226
TOUR	2,556,259	2,979,123	2,962,189	3,141,225	3,281,374	2,611,745	-20.4%	-669,629
SERV	3,205,023	3,259,079	3,206,108	3,309,931	3,492,226	3,764,910	7.8%	272,684
PROF	550,566	524,920	557,582	553,109	608,535	625,505	2.8%	16,970
UTIL	876,990	869,889	921,683	996,311	1,243,247	1,087,774	-12.5%	-155,473
MANU	203,691	212,162	200,152	185,856	179,907	246,749	37.2%	66,842
TRAN	299,219	302,731	304,061	310,859	308,161	309,338	0.4%	1,177
WHLS	1,990,412	2,531,489	2,946,268	3,464,915	3,440,808	3,792,715	10.2%	351,907
GOV	687,160	745,327	749,646	777,246	822,267	885,817	7.7%	63,550
TOTAL	25,063,470	27,107,360	27,490,906	28,688,087	30,399,083	30,408,885	0.0%	9,802

Table 2.7

For complete listing of Lines of Business, see page 13

Homer 4th Quarter TAXABLE Sales History	
2002	25,063,470
2003	27,107,360
2004	27,490,906
2005	28,688,087
2006	30,399,083
2007	30,408,885

Table 2.8

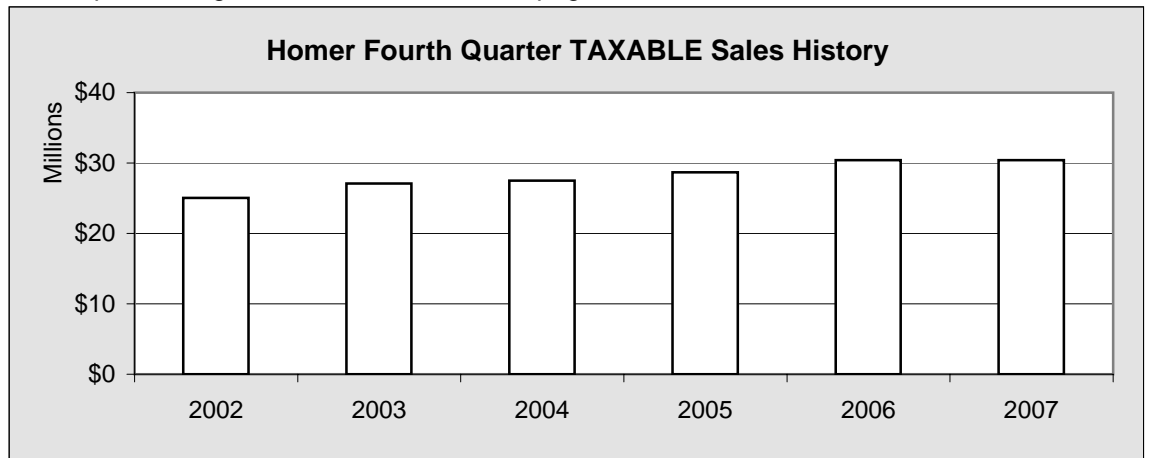

Chart 2.12

Homer Five Year Change 4th Quarter TAXABLE Sales		
LOB	2002	2007
RSRC	13,191	22,511
SALES	13,012,862	15,376,256
CONST	294,548	282,788
PROP	1,373,549	1,402,777
TOUR	2,556,259	2,611,745
SERV	3,205,023	3,764,910
PROF	550,566	625,505
UTIL	876,990	1,087,774
MANU	203,691	246,749
TRAN	299,219	309,338
WHLS	1,990,412	3,792,715
GOV	687,160	885,817

Table 2.9

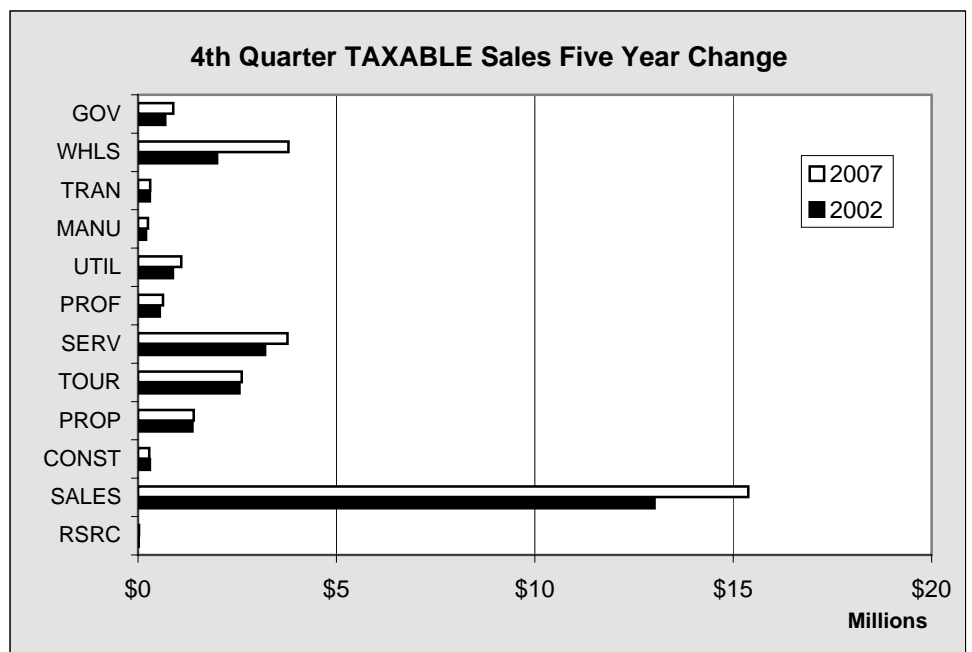

Chart 2.13

Homer Sales

Homer Annual GROSS Sales by Line of Business - 2002-2007 - in \$

LOB	2002	2003	2004	2005	2006	2007	Annual Percent Change	Annual Amount Change
RSRC	1,552,731	1,797,196	1,191,065	405,362	374,556	2,384,932	536.7%	2,010,376
SALES	79,268,211	86,449,334	91,949,230	95,974,770	100,197,173	103,898,700	3.7%	3,701,527
CONST	44,851,360	40,253,919	31,350,774	37,470,356	55,796,139	42,318,134	-24.2%	-13,478,005
PROP	10,954,617	12,007,266	13,676,384	13,101,677	14,010,450	16,286,327	16.2%	2,275,877
TOUR	21,017,649	22,501,768	24,687,856	25,786,385	28,990,268	28,309,124	-2.3%	-681,144
SERV	23,422,931	24,983,092	26,776,948	29,430,798	35,204,843	41,098,626	16.7%	5,893,783
PROF	8,109,163	10,502,846	10,856,028	9,166,842	8,946,338	9,865,350	10.3%	919,012
UTIL	30,297,596	27,145,942	31,642,148	34,464,246	43,313,320	35,615,708	-17.8%	-7,697,612
MANU	3,455,944	4,310,474	4,188,719	4,424,282	5,174,930	5,908,616	14.2%	733,686
TRAN	14,882,755	14,075,153	17,440,514	18,005,225	18,391,753	21,309,934	15.9%	2,918,181
WHLS	21,826,628	26,382,700	32,800,561	37,974,529	41,867,079	37,594,636	-10.2%	-4,272,443
GOV	3,601,099	3,664,092	3,821,622	3,948,647	3,997,559	4,108,884	2.8%	111,325
TOTAL	263,240,684	274,073,782	290,381,849	310,153,119	356,264,408	348,698,971	-2.1%	-7,565,437

Table 2.10

For complete listing of Lines of Business, see page 13

Homer Annual GROSS Sales History	
2002	263,240,684
2003	274,073,782
2004	290,381,849
2005	310,153,119
2006	356,264,408
2007	348,698,971

Table 2.11

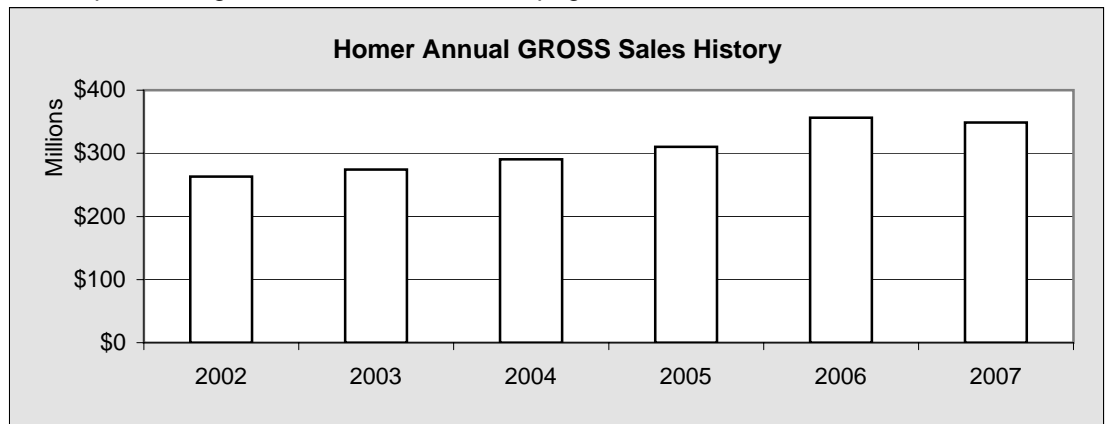

Chart 2.14

Five Year Change Annual GROSS Sales		
LOB	2002	2007
RSRC	1,552,731	2,384,932
SALES	79,268,211	103,898,700
CONST	44,851,360	42,318,134
PROP	10,954,617	16,286,327
TOUR	21,017,649	28,309,124
SERV	23,422,931	41,098,626
PROF	8,109,163	9,865,350
UTIL	30,297,596	35,615,708
MANU	3,455,944	5,908,616
TRAN	14,882,755	21,309,934
WHLS	21,826,628	37,594,636
GOV	3,601,099	4,108,884

Table 2.12

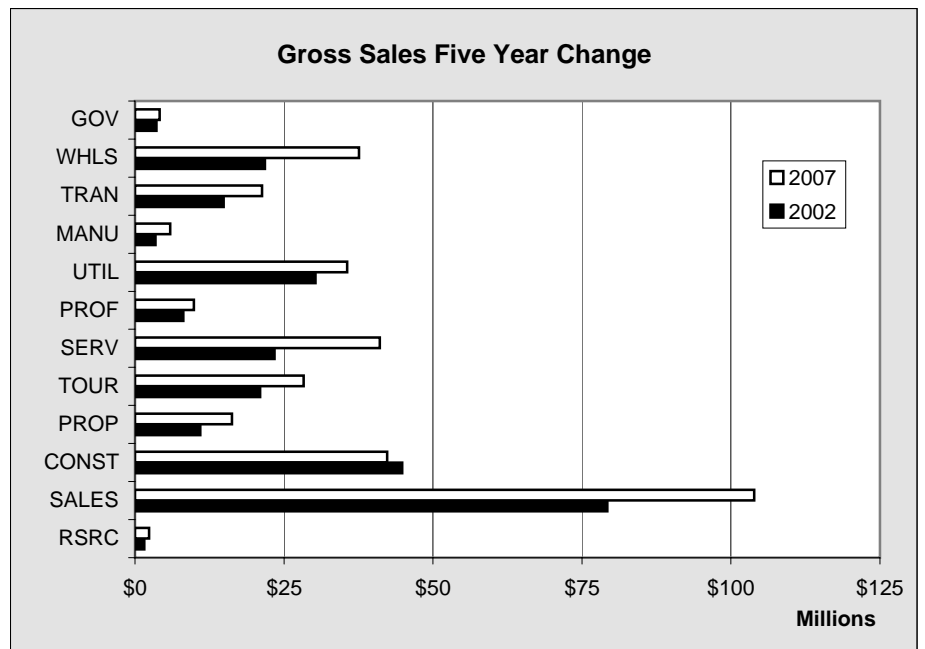

Chart 2.15

Homer Sales

Homer Annual TAXABLE Sales by Line of Business - 2002-2007 - in \$								
LOB	2002	2003	2004	2005	2006	2007	Annual Percent Change	Annual Amount Change
RSRC	68,229	96,979	127,658	118,571	117,473	130,275	10.9%	12,802
SALES	56,694,965	61,669,819	64,421,458	66,585,812	69,685,826	73,832,520	6.0%	4,146,694
CONST	1,143,680	1,178,825	1,016,622	1,008,689	1,002,124	1,092,606	9.0%	90,482
PROP	5,332,901	5,605,925	6,139,463	5,880,695	6,178,499	7,083,552	14.6%	905,053
TOUR	19,188,899	20,732,428	22,495,614	23,845,211	26,870,594	25,868,423	-3.7%	-1,002,171
SERV	13,133,915	14,034,427	14,523,104	14,546,416	15,186,841	18,207,092	19.9%	3,020,251
PROF	2,280,076	2,351,152	2,386,438	2,411,633	2,578,844	2,669,585	3.5%	90,741
UTIL	3,289,105	3,561,037	3,464,301	3,855,271	4,456,860	4,494,479	0.8%	37,619
MANU	979,814	1,139,927	1,166,080	959,822	1,002,671	1,402,914	39.9%	400,243
TRAN	6,476,069	6,353,912	7,120,009	7,309,832	6,549,034	8,304,822	26.8%	1,755,788
WHLS	9,103,796	11,340,673	13,251,309	15,190,505	15,733,320	17,120,321	8.8%	1,387,001
GOV	3,601,099	3,664,092	3,821,622	3,948,647	3,939,804	4,079,127	3.5%	139,323
TOTAL	121,292,548	131,729,196	139,933,678	145,661,104	153,301,890	164,285,716	7.2%	10,983,826

Table 2.13 For complete listing of Lines of Business, see page 13

Homer Annual TAXABLE Sales History	
2002	121,292,548
2003	131,729,196
2004	139,933,678
2005	145,661,104
2006	153,301,890
2007	164,285,716

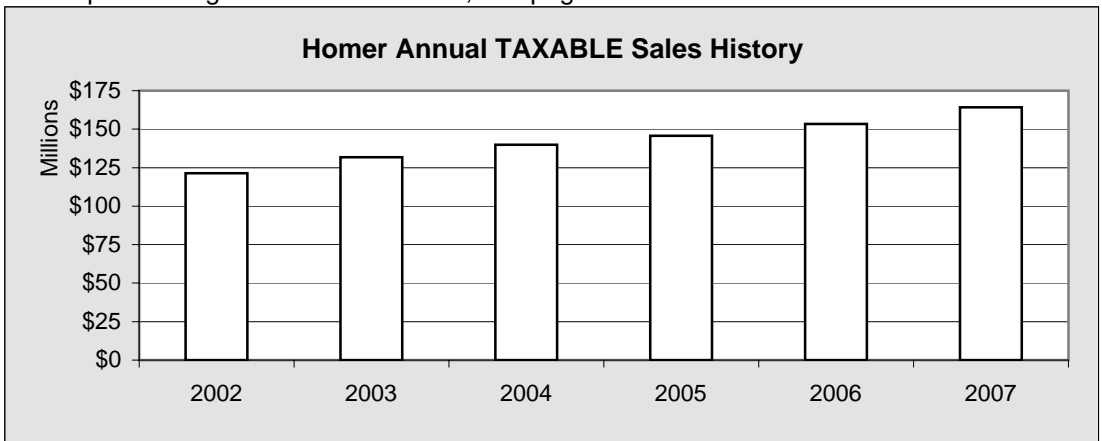

Table 2.14

Chart 2.16

Five Year Change Annual TAXABLE Sales		
LOB	2002	2007
RSRC	68,229	130,275
SALES	56,694,965	73,832,520
CONST	1,143,680	1,092,606
PROP	5,332,901	7,083,552
TOUR	19,188,899	25,868,423
SERV	13,133,915	18,207,092
PROF	2,280,076	2,669,585
UTIL	3,289,105	4,494,479
MANU	979,814	1,402,914
TRAN	6,476,069	8,304,822
WHLS	9,103,796	17,120,321
GOV	3,601,099	4,079,127

Table 2.15

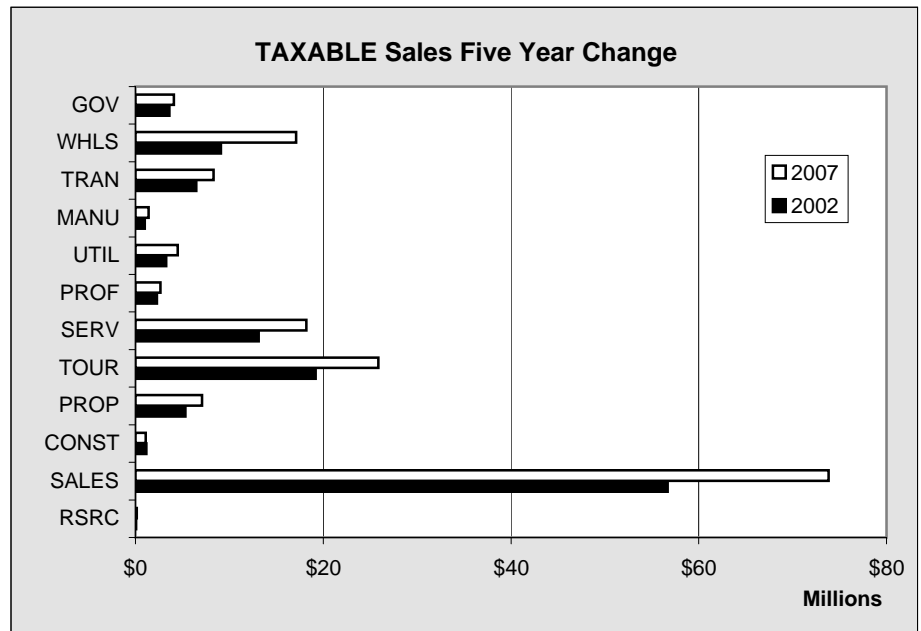

Chart 2.17

Homer Sales

Homer GROSS Sales by Line of Business by Quarter - 2007 - in \$					
LOB	1st Quarter	2nd Quarter	3rd Quarter	4th Quarter	Total
Resource Production	36,802	106,766	797,585	1,443,779	2,384,932
Sales	17,381,367	29,396,373	33,996,886	23,124,074	103,898,700
Construction	6,816,277	10,168,462	16,085,673	9,247,722	42,318,134
Property	2,859,969	4,394,243	5,382,214	3,649,901	16,286,327
Tourism	3,629,468	8,778,473	12,953,128	2,948,055	28,309,124
Services	6,714,585	13,046,957	13,544,433	7,792,651	41,098,626
Professional	2,560,602	2,385,855	2,404,488	2,514,405	9,865,350
Utility	11,496,157	11,107,659	1,854,484	11,157,408	35,615,708
Manufacturing	896,910	1,677,899	1,851,617	1,482,190	5,908,616
Transporation & Warehousing	1,194,685	5,206,126	11,378,727	3,530,396	21,309,934
Wholesale	7,218,174	10,083,265	11,835,375	8,457,822	37,594,636
Government	611,944	991,182	1,619,941	885,817	4,108,884
TOTAL	61,416,940	97,343,260	113,704,551	76,234,220	348,698,971

Table 2.16

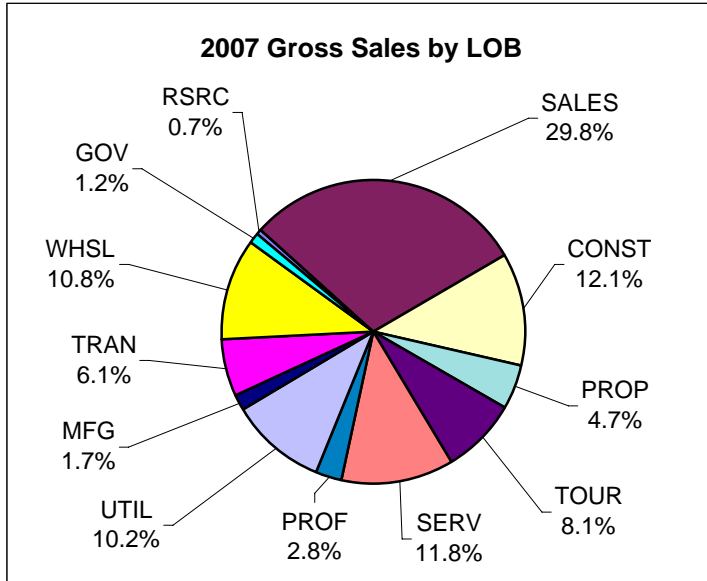

Chart 2.18

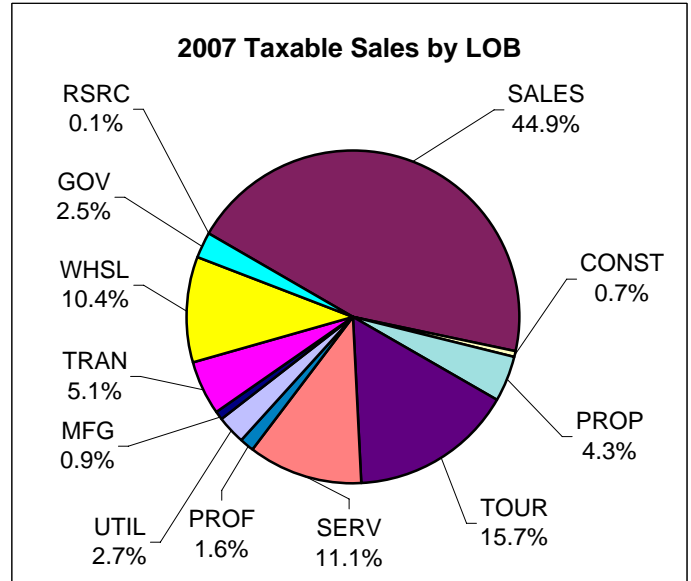

Chart 2.19

Homer TAXABLE Sales by Line of Business by Quarter - 2007 - in \$					
LOB	1st Quarter	2nd Quarter	3rd Quarter	4th Quarter	Total
Resource Production	4,257	53,232	50,275	22,511	130,275
Sales	13,068,366	21,400,414	23,987,484	15,376,256	73,832,520
Construction	186,517	266,138	357,163	282,788	1,092,606
Property	1,163,270	1,801,965	2,715,540	1,402,777	7,083,552
Tourism	3,306,585	8,037,960	11,912,133	2,611,745	25,868,423
Services	3,270,084	5,199,716	5,972,382	3,764,910	18,207,092
Professional	638,962	751,099	654,019	625,505	2,669,585
Utility	1,352,338	1,029,995	1,024,372	1,087,774	4,494,479
Manufacturing	168,702	436,693	550,770	246,749	1,402,914
Transporation & Warehousing	248,524	2,651,790	5,095,170	309,338	8,304,822
Wholesale	3,234,493	4,595,812	5,497,301	3,792,715	17,120,321
Government	611,944	991,182	1,590,184	885,817	4,079,127
TOTAL	27,254,042	47,215,996	59,406,793	30,408,885	164,285,716

Table 2.17

Homer Sales

Homer GROSS Sales by Line of Business by Quarter - 2006 - in \$					
LOB	1st Quarter	2nd Quarter	3rd Quarter	4th Quarter	Total
Resource Production	31,779	124,507	145,395	72,875	374,556
Sales	17,505,982	27,971,994	32,048,614	22,670,583	100,197,173
Construction	4,433,669	7,144,231	22,786,641	21,431,598	55,796,139
Property	2,575,989	3,423,639	4,378,758	3,632,064	14,010,450
Tourism	3,583,937	8,721,008	13,041,226	3,644,097	28,990,268
Services	6,572,652	11,574,720	9,164,414	7,893,057	35,204,843
Professional	1,791,923	2,207,945	2,010,147	2,936,323	8,946,338
Utility	10,418,274	10,115,928	10,735,993	12,043,125	43,313,320
Manufacturing	805,268	1,488,751	1,494,147	1,386,764	5,174,930
Transportation & Warehousing	1,170,489	5,390,057	9,970,732	1,860,475	18,391,753
Wholesale	6,684,002	10,146,228	11,189,145	13,847,704	41,867,079
Government	613,530	1,022,191	1,539,571	822,267	3,997,559
TOTAL	56,187,494	89,331,199	118,504,783	92,240,932	356,264,408

Table 2.18

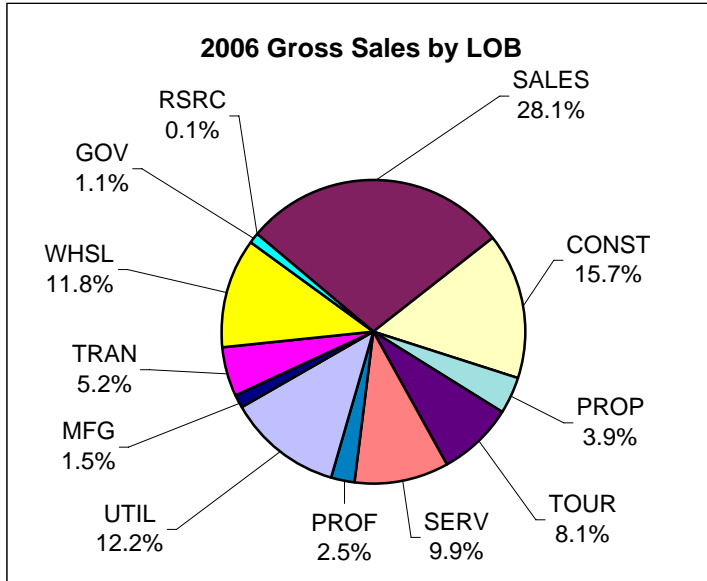

Chart 2.20

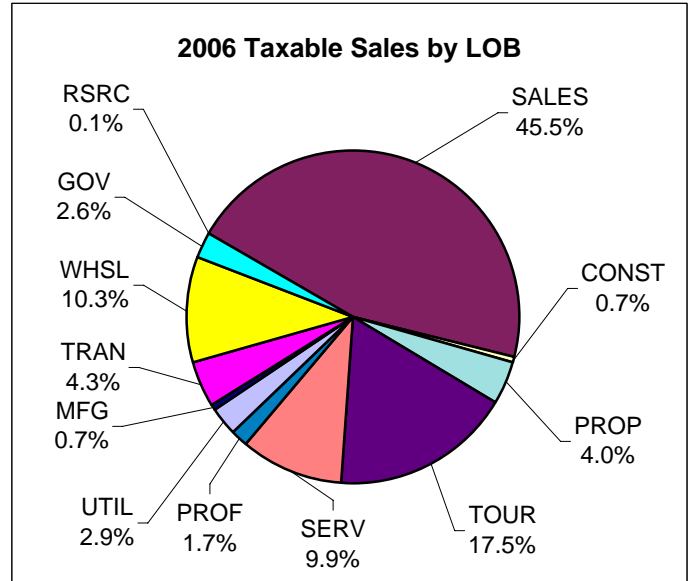

Chart 2.21

Homer TAXABLE Sales by Line of Business by Quarter - 2006 - in \$					
LOB	1st Quarter	2nd Quarter	3rd Quarter	4th Quarter	Total
Resource Production	1,935	56,938	45,421	13,179	117,473
Sales	12,384,298	19,847,962	22,063,348	15,390,218	69,685,826
Construction	184,045	254,714	294,755	268,610	1,002,124
Property	1,148,319	1,520,323	2,159,306	1,350,551	6,178,499
Tourism	3,256,772	8,056,249	12,276,199	3,281,374	26,870,594
Services	3,091,491	4,151,581	4,451,543	3,492,226	15,186,841
Professional	590,801	739,680	639,828	608,535	2,578,844
Utility	1,279,979	1,006,828	926,806	1,243,247	4,456,860
Manufacturing	138,538	296,859	387,367	179,907	1,002,671
Transportation & Warehousing	292,130	2,163,960	3,784,783	308,161	6,549,034
Wholesale	2,754,910	4,302,775	5,234,827	3,440,808	15,733,320
Government	613,530	996,266	1,507,741	822,267	3,939,804
TOTAL	25,736,748	43,394,135	53,771,924	30,399,083	153,301,890

Table 2.19

Homer Sales

Homer GROSS Sales by Line of Business by Quarter - 2005 - in \$					
LOB	1st Quarter	2nd Quarter	3rd Quarter	4th Quarter	Total
Resource Production	62,521	133,823	125,218	83,800	405,362
Sales	17,001,264	27,858,440	30,379,785	20,735,281	95,974,770
Construction	5,072,675	11,142,686	12,486,986	8,768,009	37,470,356
Property	2,483,830	3,208,860	4,022,638	3,386,349	13,101,677
Tourism	3,325,990	7,843,290	11,152,861	3,464,244	25,786,385
Services	5,424,976	8,441,271	9,080,680	6,483,871	29,430,798
Professional	1,863,220	2,064,840	2,156,550	3,082,232	9,166,842
Utility	8,384,387	8,517,405	8,728,814	8,833,640	34,464,246
Manufacturing	571,781	1,291,713	1,364,110	1,196,678	4,424,282
Transportation & Warehousing	1,099,062	5,568,841	9,955,159	1,382,163	18,005,225
Wholesale	5,937,156	9,153,665	10,478,037	12,405,671	37,974,529
Government	654,783	961,634	1,554,984	777,246	3,948,647
TOTAL	51,881,645	86,186,468	101,485,822	70,599,184	310,153,119

Table 2.20

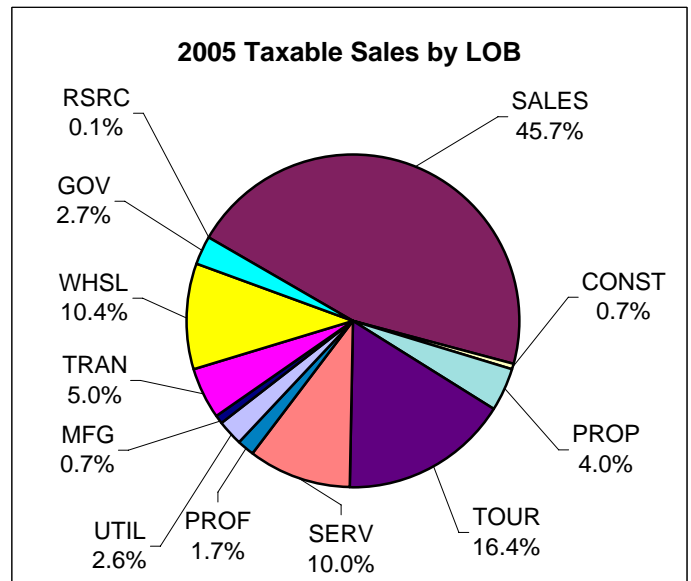
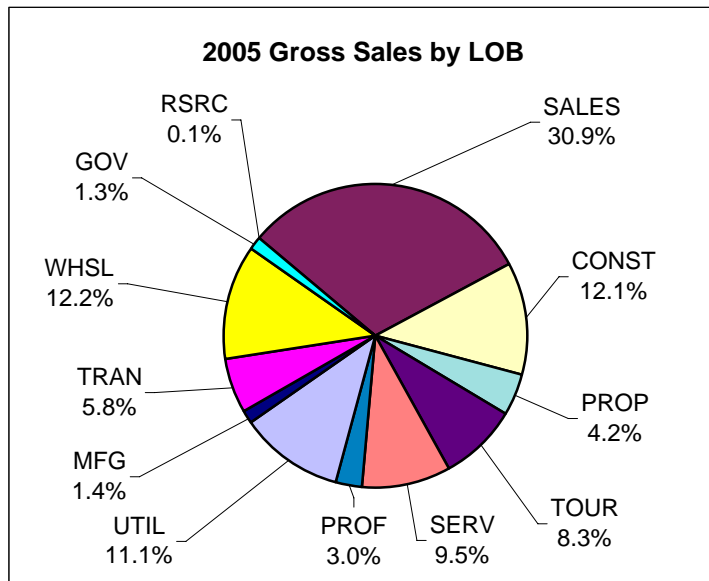

Chart 2.22

Chart 2.23

Homer TAXABLE Sales by Line of Business by Quarter - 2005 - in \$					
LOB	1st Quarter	2nd Quarter	3rd Quarter	4th Quarter	Total
Resource Production	12,177	43,432	43,163	19,799	118,571
Sales	11,875,692	19,321,269	21,034,370	14,354,481	66,585,812
Construction	179,152	264,244	323,121	242,172	1,008,689
Property	1,132,119	1,398,598	2,017,795	1,332,183	5,880,695
Tourism	2,982,703	7,181,866	10,539,417	3,141,225	23,845,211
Services	2,954,206	4,008,387	4,273,892	3,309,931	14,546,416
Professional	611,092	624,848	622,584	553,109	2,411,633
Utility	1,017,743	938,525	902,692	996,311	3,855,271
Manufacturing	139,987	295,430	338,549	185,856	959,822
Transportation & Warehousing	314,472	2,359,692	4,324,809	310,859	7,309,832
Wholesale	2,459,117	4,094,900	5,171,573	3,464,915	15,190,505
Government	654,783	961,634	1,554,984	777,246	3,948,647
TOTAL	24,333,243	41,492,825	51,146,949	28,688,087	145,661,104

Table 2.21

Homer Construction Permits

Homer 4th Quarter Permit VALUES by Type - 2001-2007 - in \$

	2001	2002	2003	2004	2005	2006	2007	Annual Change
Residential New	492,300	560,200	1,222,900	377,000	895,000	550,000	845,000	53.6%
Residential Alter/Add	120,000	104,320	50,000	437,000	80,000	5,000	476,000	9420.0%
Commercial New	300,000	78,000	1,600,000	2,560,000	1,975,000	2,000,000	301,000	-85.0%
Commercial Alter/Add	11,100,000	72,000	170,000	17,000	27,000	0	0	0.0%
Total	12,012,300	814,520	3,042,900	3,391,000	2,977,000	2,555,000	1,622,000	-36.5%
Annual Change		-93.2%	273.6%	11.4%	-12.2%	-14.2%	-36.5%	

Table 2.22

Homer 4th Quarter Permit VALUES by Type - 1986-2007

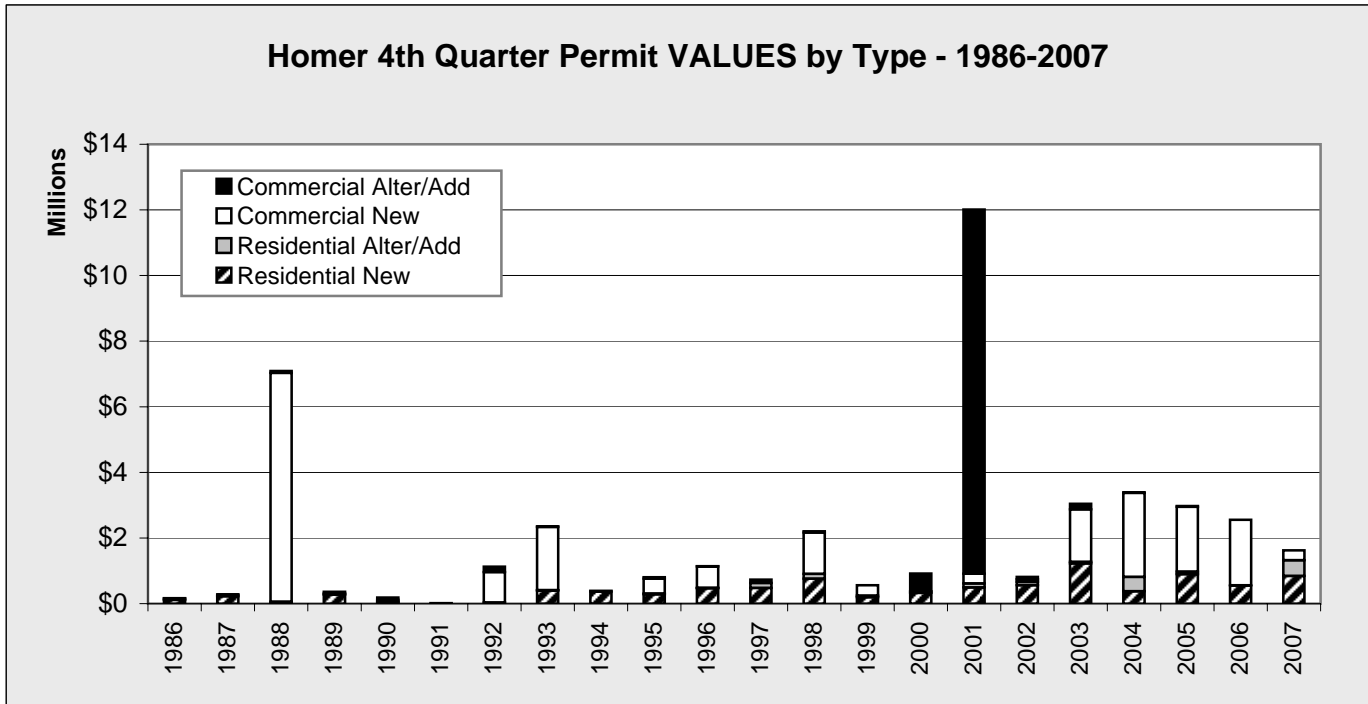

Chart 2.24

Homer 4th Quarter Permit VALUES Percent by Type - 2007

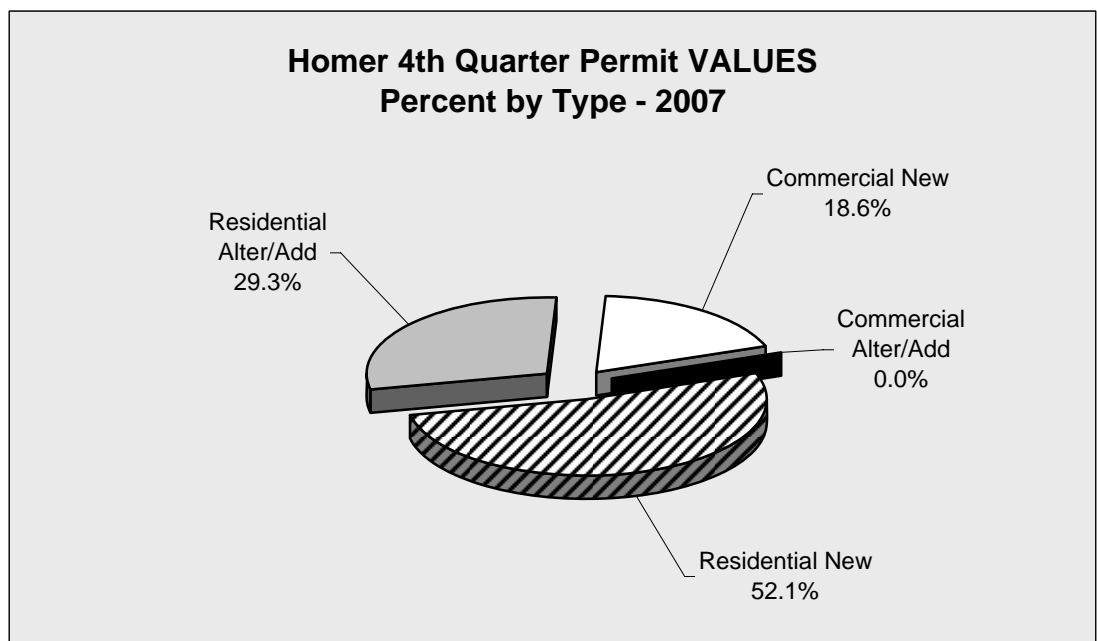

Chart 2.25

Homer Construction Permits

Homer 4th Quarter Permit VOLUME by Type - 2001-2007

	2001	2002	2003	2004	2005	2006	2007	Annual Change
Residential New	4	5	9	6	6	2	5	150.0%
Residential Alter/Add	2	6	2	9	2	1	8	700.0%
Commercial New	1	1	1	7	2	2	3	50.0%
Commercial Alter/Add	2	1	1	2	1	0	0	NA
Total	9	13	13	24	11	5	16	220.0%
Annual Change		44.4%	0.0%	84.6%	-54.2%	-54.5%	220.0%	

Table 2.23

Homer 4th Quarter Permit VOLUME by Type - 1986-2007

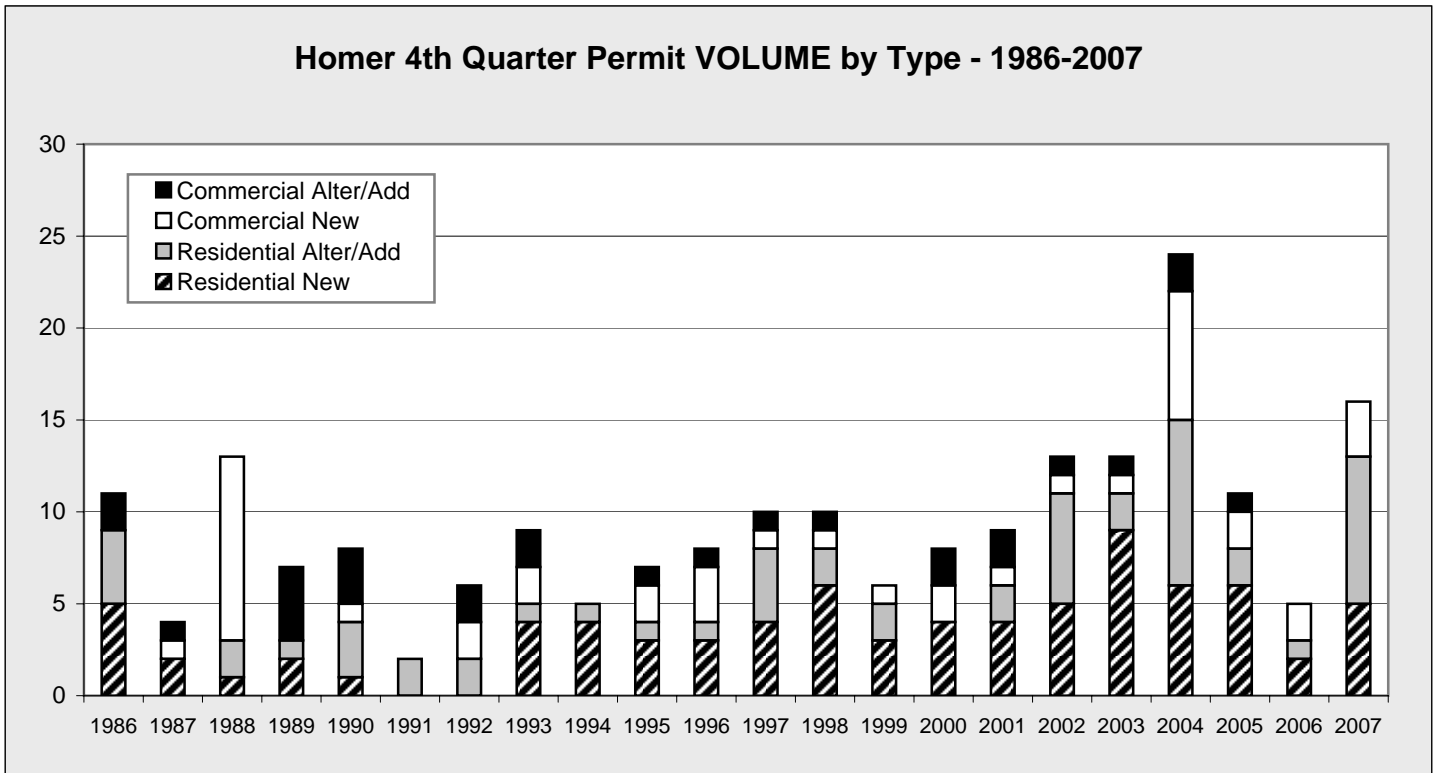

Chart 2.26

Homer 4th Quarter Permit VOLUME Percent by Type - 2007

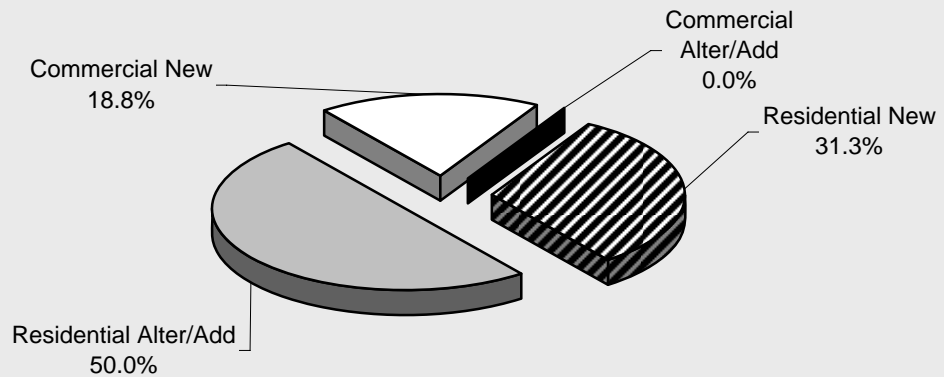

Chart 2.27

Homer Construction Permits

Homer Annual Permit VALUES by Type - 2001-2007 - in \$								
	2001	2002	2003	2004	2005	2006	2007	Annual Change
Residential New	4,047,780	4,226,720	8,120,455	6,695,500	7,209,900	10,055,800	7,650,100	-23.9%
Residential Alter/Add	609,160	536,620	806,600	1,695,550	906,500	541,057	1,632,500	201.7%
Commercial New	2,410,800	4,990,740	5,764,520	14,400,518	11,796,000	8,071,000	4,717,601	-41.5%
Commercial Alter/Add	12,732,950	294,699	635,240	1,279,063	1,699,000	1,620,000	66,000	-95.9%
Total	19,800,690	10,048,779	15,326,815	24,070,631	21,611,400	20,287,857	14,066,201	-30.7%
Annual Change		-49.3%	52.5%	57.0%	-10.2%	-6.1%	-30.7%	

Table 2.24

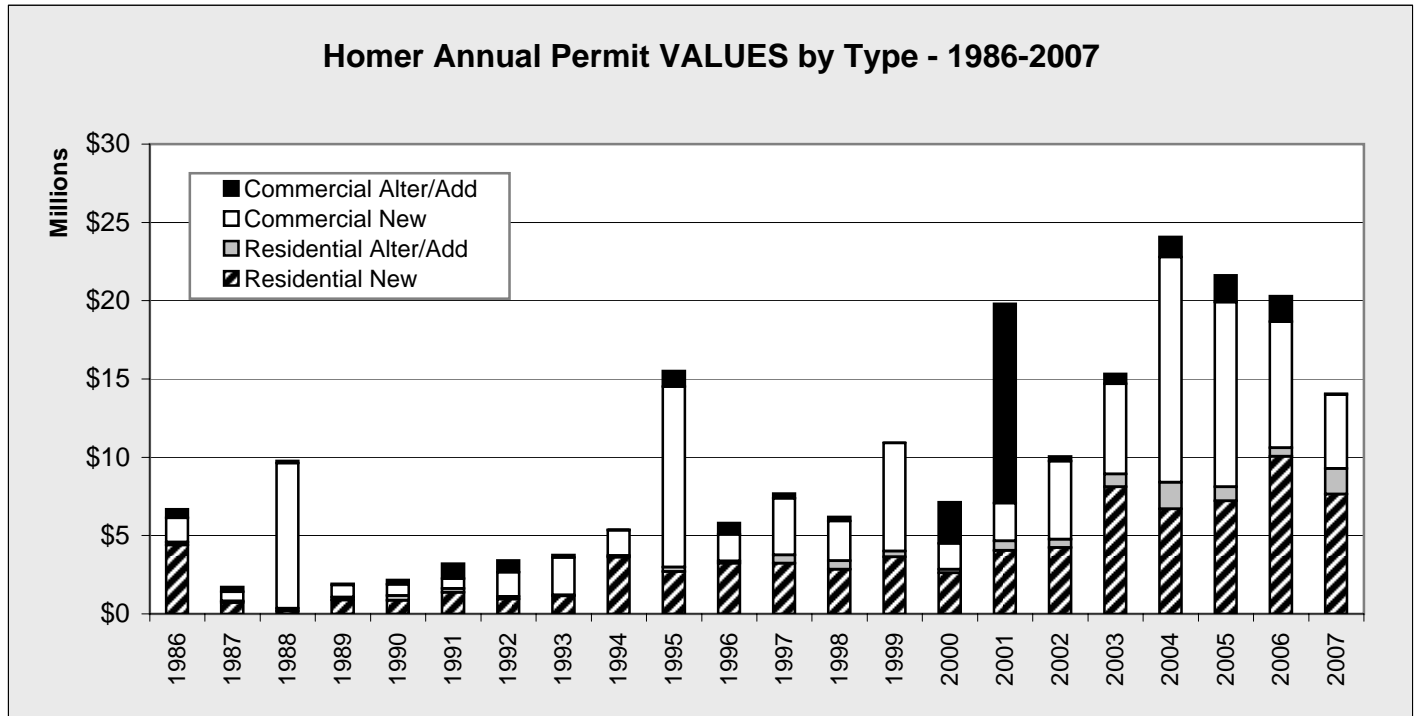

Chart 2.28

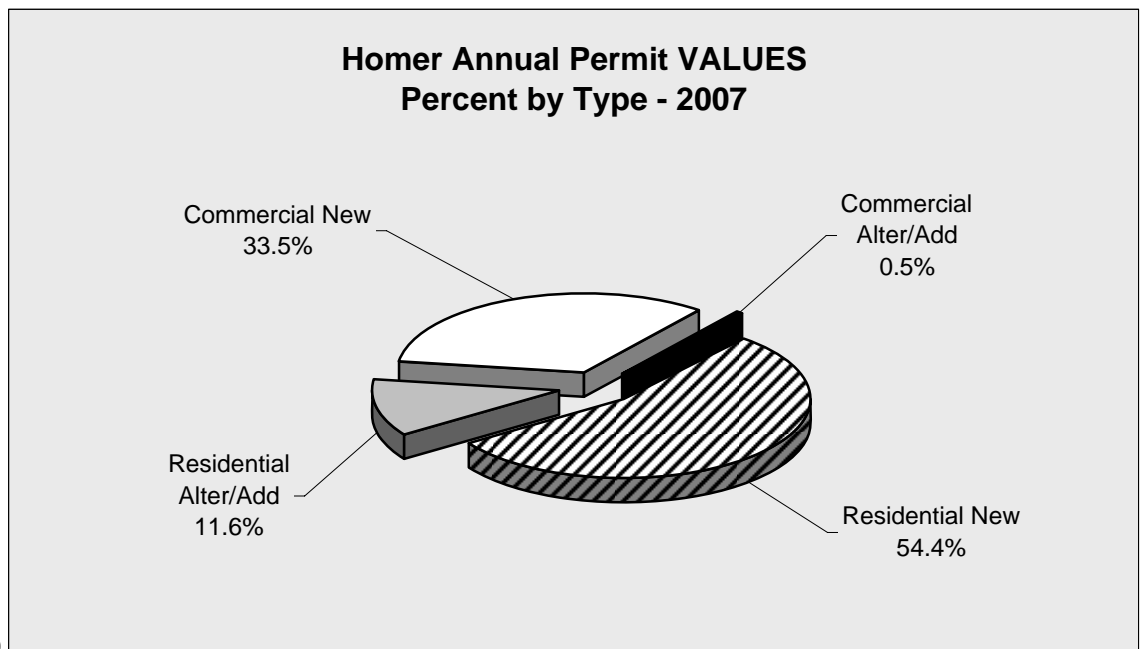

Chart 2.29

Homer Construction Permits

Homer Annual Permit VOLUME by Type - 2001-2007

	2001	2002	2003	2004	2005	2006	2007	Annual Change
Residential New	30	32	47	41	51	49	41	-16.3%
Residential Alter/Add	19	20	19	37	25	16	28	75.0%
Commercial New	8	8	11	22	18	14	16	14.3%
Commercial Alter/Add	15	7	9	8	9	4	2	-50.0%
Total	72	67	86	108	103	83	87	4.8%
Annual Change		-6.9%	28.4%	25.6%	-4.6%	-19.4%	4.8%	

Table 2.25

Homer Annual Permit VOLUME by Type - 1986-2007

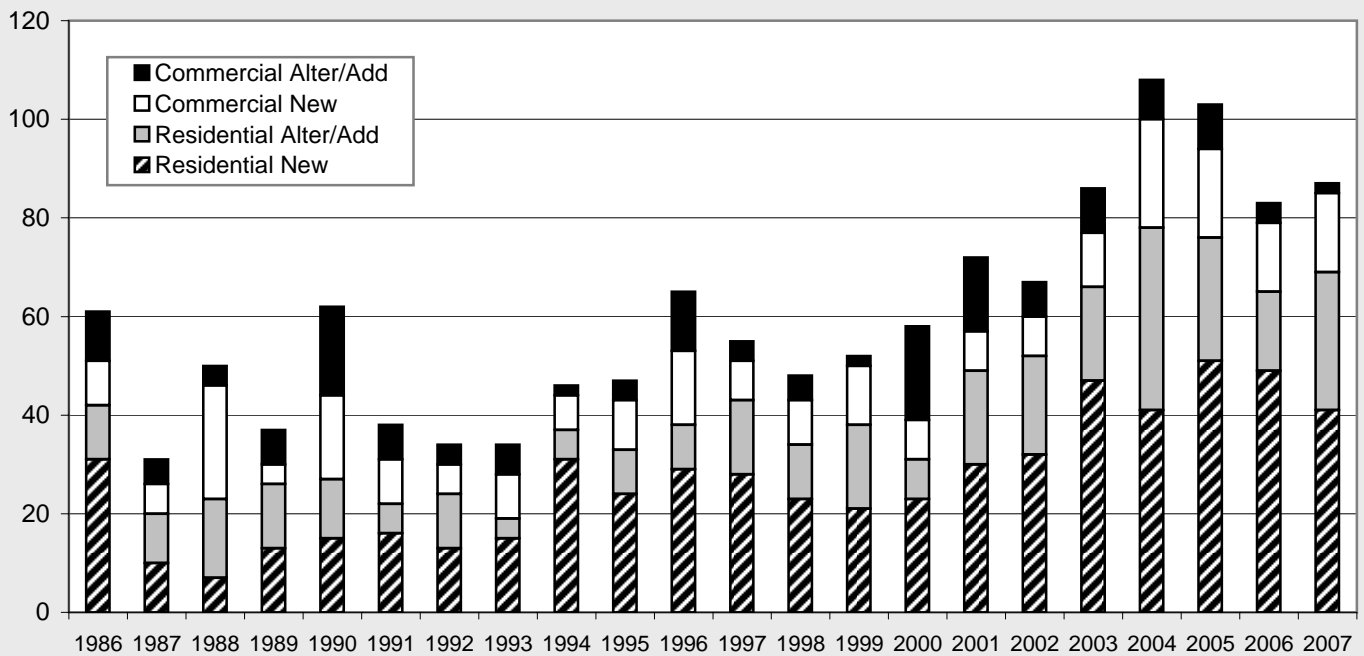

Chart 2.30

Homer Annual Permit VOLUME Percent by Type - 2007

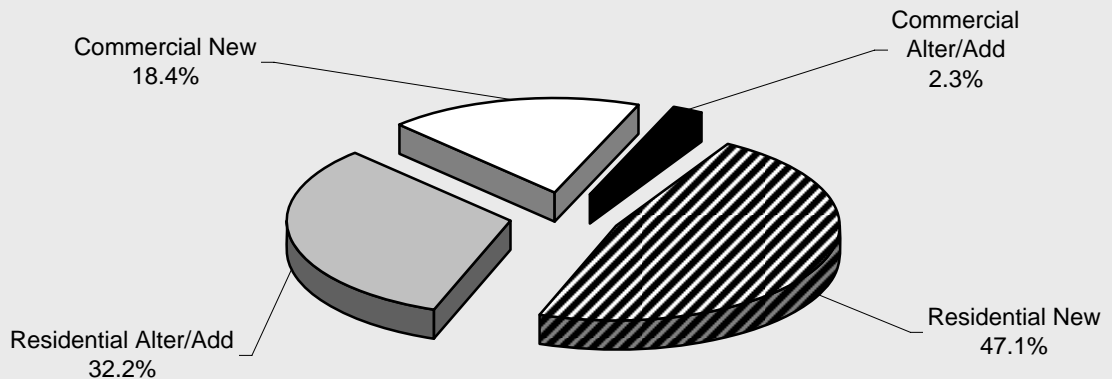

Chart 2.31

Homer Construction Permits

Homer Annual Permit VALUE by Type by Quarter - 2000-2007 - in \$					
	1st Quarter	2nd Quarter	3rd Quarter	4th Quarter	Total
2000					
Residential - New	392,600	867,440	1,025,000	326,000	2,611,040
Residential - Add/Alter	5,500	115,000	109,560	0	230,060
Commercial - New	85,000	725,480	805,000	48,000	1,663,480
Commercial - Add/Alter	1,315,000	558,000	207,410	543,982	2,624,392
TOTAL	1,798,100	2,265,920	2,146,970	917,982	7,128,972
2001					
Residential - New	300,000	2,093,800	1,161,680	492,300	4,047,780
Residential - Add/Alter	60,000	306,440	122,720	120,000	609,160
Commercial - New	285,000	1,485,800	340,000	300,000	2,410,800
Commercial - Add/Alter	45,000	216,000	1,371,950	11,100,000	12,732,950
TOTAL	690,000	4,102,040	2,996,350	12,012,300	19,800,690
2002					
Residential - New	891,760	1,308,460	1,466,300	560,200	4,226,720
Residential - Add/Alter	8,960	205,400	217,940	104,320	536,620
Commercial - New	0	1,000,000	3,912,740	78,000	4,990,740
Commercial - Add/Alter	28,000	14,349	180,350	72,000	294,699
TOTAL	928,720	2,528,209	5,777,330	814,520	10,048,779
2003					
Residential - New	979,800	3,811,480	2,106,275	1,222,900	8,120,455
Residential - Add/Alter	232,540	239,060	285,000	50,000	806,600
Commercial - New	0	3,535,720	628,800	1,600,000	5,764,520
Commercial - Add/Alter	122,000	343,240	0	170,000	635,240
TOTAL	1,334,340	7,929,500	3,020,075	3,042,900	15,326,815
2004					
Residential - New	2,597,500	2,495,400	1,225,600	377,000	6,695,500
Residential - Add/Alter	201,520	205,730	851,300	437,000	1,695,550
Commercial - New	915,000	4,700,518	6,225,000	2,560,000	14,400,518
Commercial - Add/Alter	0	32,063	1,230,000	17,000	1,279,063
TOTAL	3,714,020	7,433,711	9,531,900	3,391,000	24,070,631
2005					
Residential - New	1,694,400	3,072,000	1,548,500	895,000	7,209,900
Residential - Add/Alter	1,500	451,000	374,000	80,000	906,500
Commercial - New	108,000	7,473,000	2,240,000	1,975,000	11,796,000
Commercial - Add/Alter	1,302,000	250,000	120,000	27,000	1,699,000
TOTAL	3,105,900	11,246,000	4,282,500	2,977,000	21,611,400
2006					
Residential - New	1,645,000	4,250,100	3,610,700	550,000	10,055,800
Residential - Add/Alter	0	287,000	249,057	5,000	541,057
Commercial - New	626,000	2,310,000	3,135,000	2,000,000	8,071,000
Commercial - Add/Alter	1,000,000	620,000	0	0	1,620,000
TOTAL	3,271,000	7,467,100	6,994,757	2,555,000	20,287,857
2007					
Residential - New	0	4,760,000	2,045,100	845,000	7,650,100
Residential - Add/Alter	0	482,000	674,500	476,000	1,632,500
Commercial - New	0	2,095,001	2,321,600	301,000	4,717,601
Commercial - Add/Alter	0	20,000	46,000	0	66,000
TOTAL	0	7,357,001	5,087,200	1,622,000	14,066,201

Table 2.26

Homer Construction Permits

Homer Annual Permit VOLUME by Type by Quarter - 2000-2007					
	1st Quarter	2nd Quarter	3rd Quarter	4th Quarter	Total
2000					
Residential - New	4	7	8	4	23
Residential - Add/Alter	1	2	5	0	8
Commercial - New	1	3	2	2	8
Commercial - Add/Alter	3	8	6	2	19
TOTAL	9	20	21	8	58
2001					
Residential - New	3	14	9	4	30
Residential - Add/Alter	1	12	4	2	19
Commercial - New	2	3	2	1	8
Commercial - Add/Alter	1	5	7	2	15
TOTAL	7	34	22	9	72
2002					
Residential - New	8	9	10	5	32
Residential - Add/Alter	1	5	8	6	20
Commercial - New	0	1	6	1	8
Commercial - Add/Alter	1	2	3	1	7
TOTAL	10	17	27	13	67
2003					
Residential - New	6	17	15	9	47
Residential - Add/Alter	8	6	3	2	19
Commercial - New	0	7	3	1	11
Commercial - Add/Alter	4	4	0	1	9
TOTAL	18	34	21	13	86
2004					
Residential - New	11	15	9	6	41
Residential - Add/Alter	2	5	21	9	37
Commercial - New	2	5	8	7	22
Commercial - Add/Alter	1	1	4	2	8
TOTAL	16	26	42	24	108
2005					
Residential - New	10	22	13	6	51
Residential - Add/Alter	1	13	9	2	25
Commercial - New	2	10	4	2	18
Commercial - Add/Alter	5	2	1	1	9
TOTAL	18	47	27	11	103
2006					
Residential - New	9	23	15	2	49
Residential - Add/Alter	0	8	7	1	16
Commercial - New	4	5	3	2	14
Commercial - Add/Alter	1	3	0	0	4
TOTAL	14	39	25	5	83
2007					
Residential - New	2	22	12	5	41
Residential - Add/Alter	0	8	12	8	28
Commercial - New	1	9	3	3	16
Commercial - Add/Alter	0	1	1	0	2
TOTAL	3	40	28	16	87

Table 2.27

Kenai Sales

Kenai Annual Gross Sales by Quarter - in \$						
	1st Quarter	2nd Quarter	3rd Quarter	4th Quarter	Total	Annual Change
1991	23,964,674	40,562,770	46,872,982	27,327,535	138,727,961	
1992	22,773,520	37,666,653	47,296,221	32,559,151	140,295,545	1.1%
1993	24,762,542	43,361,848	50,615,555	32,346,737	151,086,682	7.7%
1994	31,235,061	42,700,947	58,938,940	38,217,421	171,092,369	13.2%
1995	32,193,561	48,092,891	66,559,556	50,757,887	197,603,895	15.5%
1996	40,009,169	53,691,216	60,425,514	45,004,959	199,130,858	0.8%
1997	39,502,354	55,496,297	62,490,851	45,710,368	203,199,870	2.0%
1998	41,054,484	53,702,365	70,886,151	46,799,617	212,442,617	4.5%
1999	39,553,648	53,871,188	66,353,121	44,064,518	203,842,475	-4.0%
2000	55,609,576	66,158,563	89,505,566	72,408,759	283,682,464	39.2%
2001	62,418,286	76,673,936	94,911,501	76,422,702	310,426,425	9.4%
2002	60,485,836	67,818,581	82,467,626	68,530,671	279,302,714	-10.0%
2003	62,048,233	67,216,551	81,160,818	72,498,893	282,924,495	1.3%
2004	61,083,004	80,388,089	97,860,710	167,965,637	407,297,440	44.0%
2005	75,559,340	102,447,996	112,280,604	175,237,181	465,525,121	14.3%
2006	63,192,410	109,236,492	121,522,565	162,364,815	456,316,282	-2.0%
2007	95,937,538	111,375,521	152,134,680	154,344,262	513,792,001	12.6%
Annual Change	51.8%	2.0%	25.2%	-4.9%	12.6%	

Table 3.1

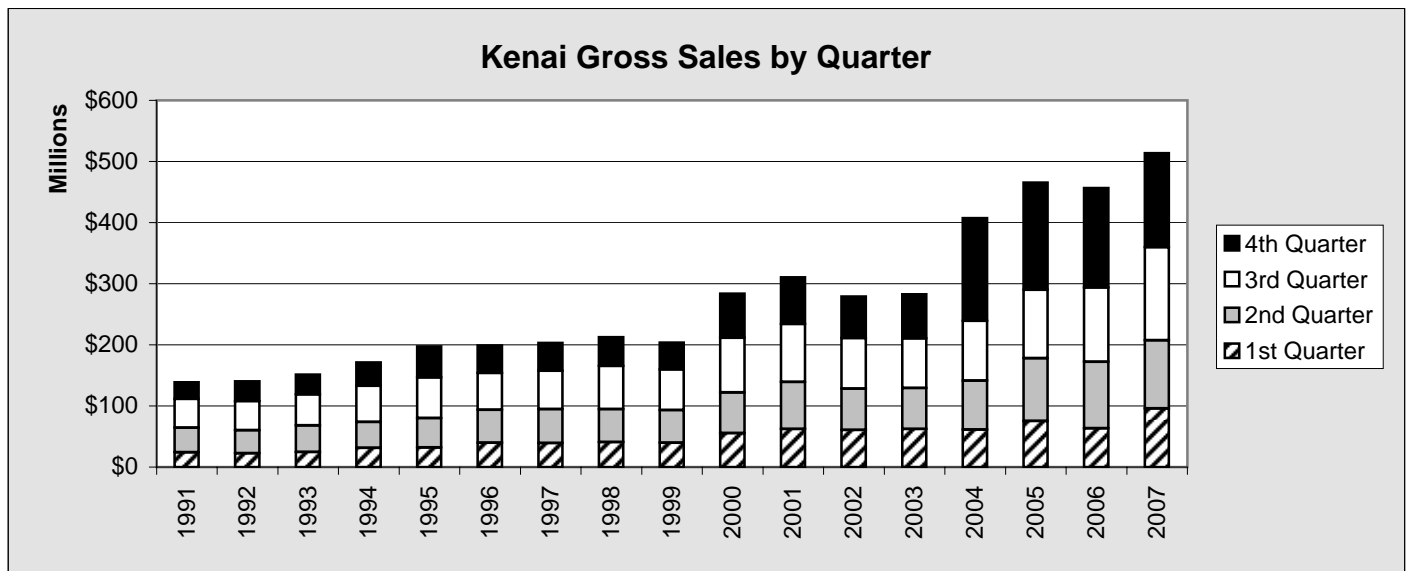

Chart 3.1

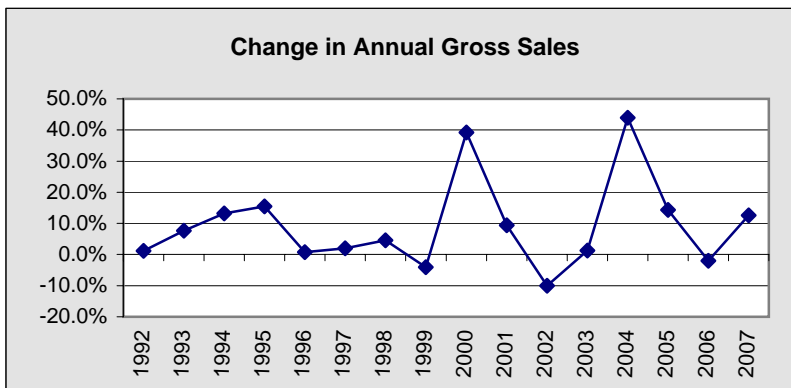

Chart 3.2

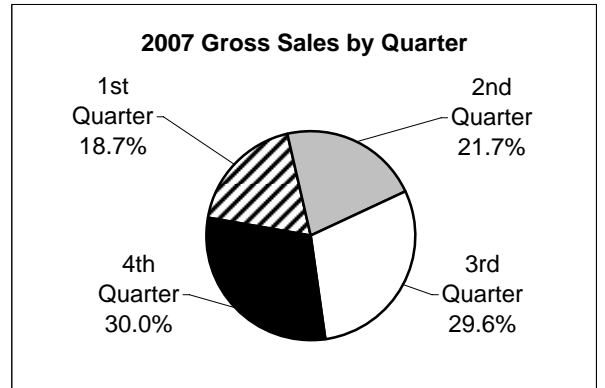

Chart 3.3

Kenai Sales

Kenai Annual Taxable Sales by Quarter - in \$						
	1st Quarter	2nd Quarter	3rd Quarter	4th Quarter	Total	Annual Change
1991	12,735,760	21,963,602	26,637,684	14,639,934	75,976,980	
1992	12,518,704	22,132,230	27,735,962	16,006,556	78,393,452	3.2%
1993	13,461,637	23,587,289	29,152,888	16,057,090	82,258,904	4.9%
1994	14,062,259	23,814,227	29,434,329	16,734,643	84,045,458	2.2%
1995	14,797,530	24,901,076	30,398,162	18,098,624	88,195,392	4.9%
1996	15,811,688	25,240,189	30,539,871	18,335,650	89,927,398	2.0%
1997	16,213,730	25,960,313	31,654,939	19,496,943	93,325,925	3.8%
1998	16,418,580	26,366,097	32,103,748	19,552,917	94,441,342	1.2%
1999	16,638,467	26,938,559	34,247,729	20,323,983	98,148,738	3.9%
2000	25,521,513	31,547,905	36,634,363	34,062,345	127,766,126	30.2%
2001	27,889,241	34,988,669	38,162,815	36,003,199	137,043,924	7.3%
2002	28,916,700	34,624,807	38,168,856	34,974,885	136,685,248	-0.3%
2003	31,103,976	29,812,054	31,362,238	29,078,527	121,356,795	-11.2%
2004	29,556,491	36,263,788	40,043,041	33,535,807	139,399,127	14.9%
2005	29,504,912	37,403,239	42,564,550	35,634,926	145,107,627	4.1%
2006	32,270,822	40,988,235	45,146,046	37,413,811	155,818,914	7.4%
2007	33,559,405	42,499,454	48,170,819	39,715,404	163,945,082	5.2%
Annual Change	4.0%	3.7%	6.7%	6.15%	5.2%	

Table 3.2

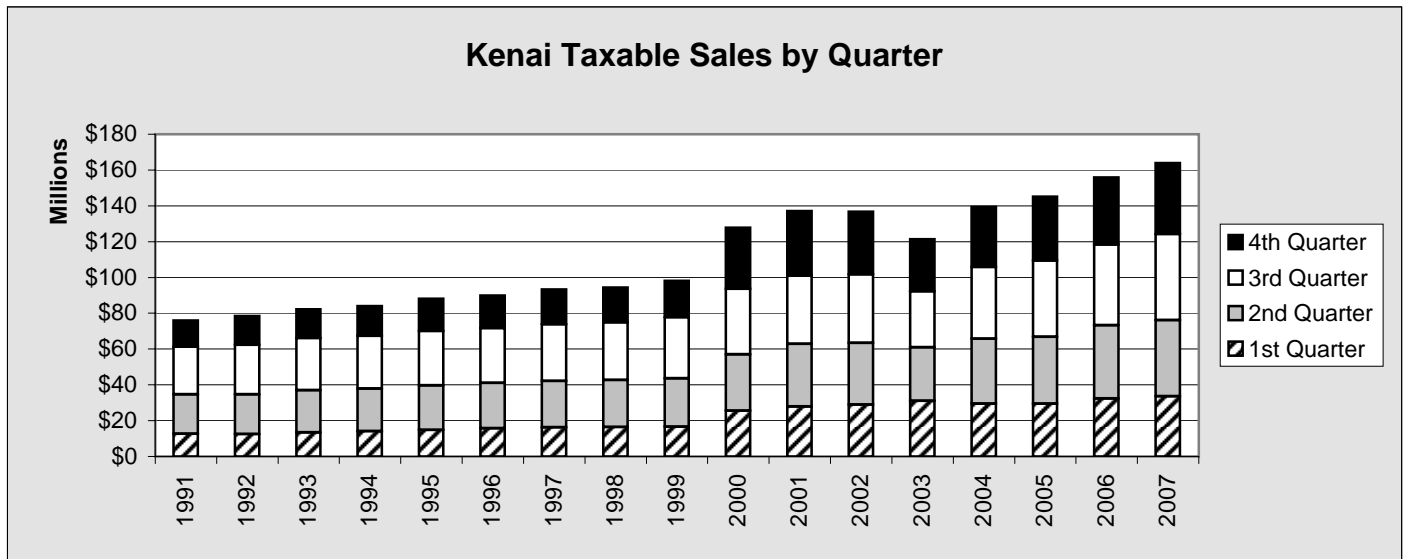

Chart 3.4

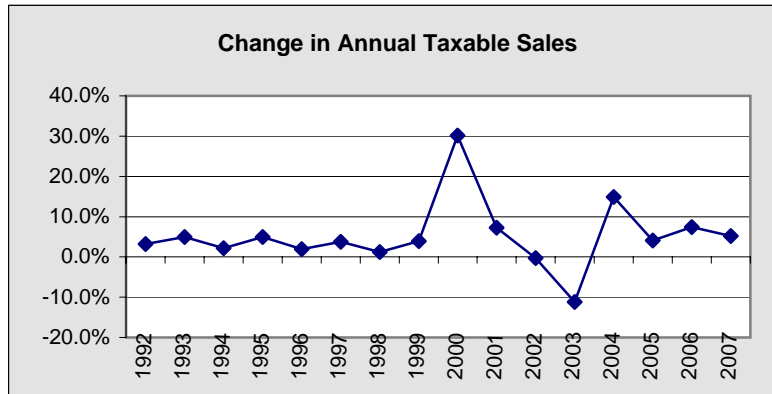

Chart 3.5

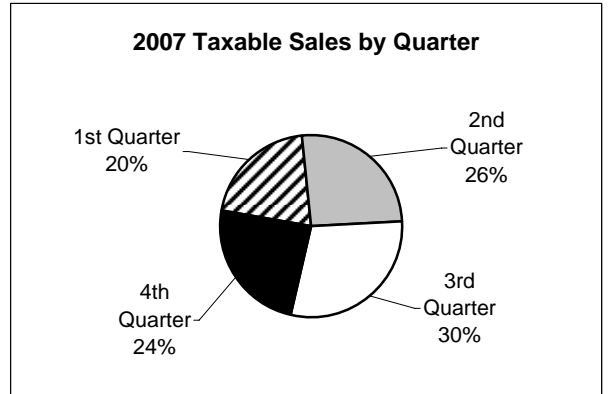

Chart 3.6

Kenai Sales

Kenai Annual Nontaxable Sales by Quarter - in \$

	1st Quarter	2nd Quarter	3rd Quarter	4th Quarter	Total	Annual Change
1991	11,228,914	18,599,168	20,235,298	12,687,601	62,750,981	
1992	10,254,816	15,534,423	19,560,259	16,552,595	61,902,093	-1.4%
1993	11,300,905	19,774,559	21,462,667	16,289,647	68,827,778	11.2%
1994	17,172,802	18,886,720	29,504,611	21,482,778	87,046,911	26.5%
1995	17,396,031	23,191,815	36,161,394	32,659,263	109,408,503	25.7%
1996	24,197,481	28,451,027	29,885,643	26,669,309	109,203,460	-0.2%
1997	23,288,624	29,535,984	30,835,912	26,213,425	109,873,945	0.6%
1998	24,635,904	27,336,268	38,782,403	27,246,700	118,001,275	7.4%
1999	22,915,181	26,932,629	32,105,392	23,740,535	105,693,737	-10.4%
2000	30,088,063	34,610,658	52,871,203	38,346,414	155,916,338	47.5%
2001	34,529,045	41,685,267	56,748,686	40,419,503	173,382,501	11.2%
2002	31,569,136	33,193,774	44,298,770	33,555,786	142,617,466	-17.7%
2003	30,944,257	37,404,497	49,798,580	43,420,366	161,567,700	13.3%
2004	31,526,513	44,124,301	57,817,669	134,429,830	267,898,313	65.8%
2005	46,054,428	65,044,757	69,716,054	139,602,255	320,417,494	19.6%
2006	30,921,588	68,248,257	76,376,519	124,951,004	300,497,368	-6.2%
2007	62,378,133	68,876,067	103,963,861	114,628,858	349,846,919	16.4%
Annual Change	101.7%	0.9%	36.1%	-8.3%	16.4%	

Table 3.3

Kenai Nontaxable Sales by Quarter

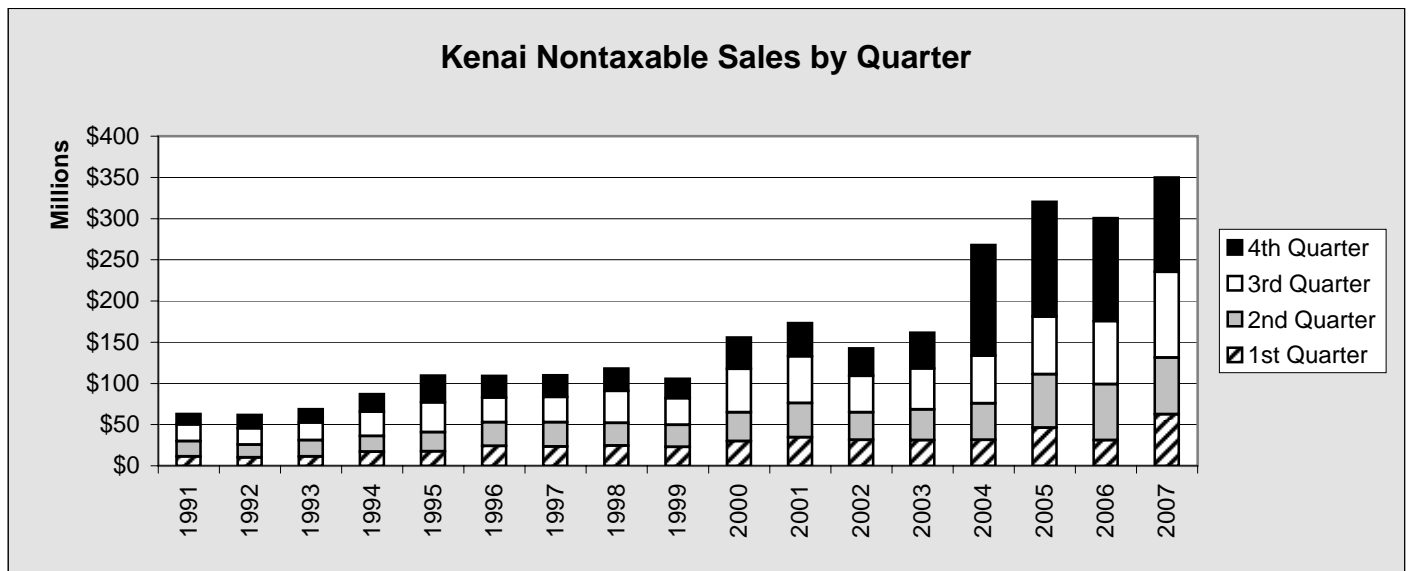

Chart 3.7

Change in Annual Nontaxable Sales

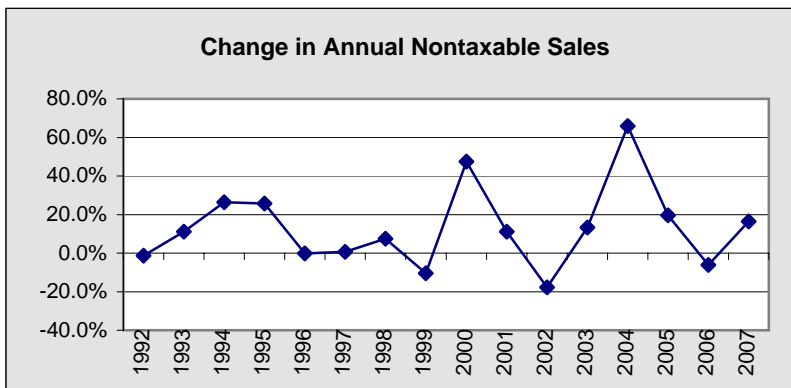

Chart 3.8

2007 Nontaxable Sales by Quarter

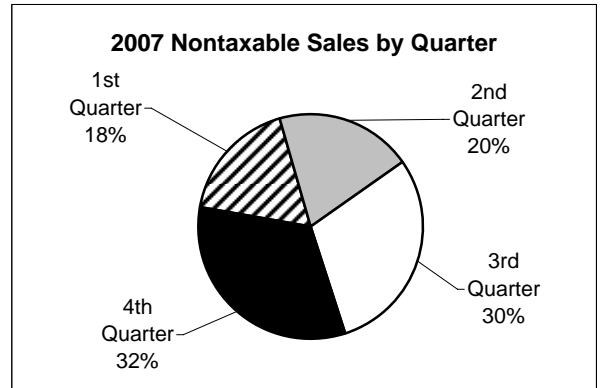

Chart 3.9

Kenai Sales

Kenai 4th Quarter GROSS Sales by Line of Business - 2002-2007 - in \$								
LOB	2002	2003	2004	2005	2006	2007	Annual Percent Change	Annual Amount Change
RSRC	643,831	1,266,351	95,796,864	74,125,421	39,163,487	39,570,701	1.0%	407,214
SALES	32,238,060	26,593,960	28,053,995	29,446,884	28,639,194	31,130,573	8.7%	2,491,379
CONST	5,527,590	12,228,280	4,367,481	6,165,315	25,093,621	8,094,873	-67.7%	-16,998,748
PROP	4,111,208	5,573,351	4,214,804	6,105,420	4,856,394	4,627,876	-4.7%	-228,518
TOUR	3,206,138	3,188,836	3,268,445	3,273,705	3,709,383	3,496,447	-5.7%	-212,936
SERV	5,437,208	4,444,307	4,797,435	4,920,767	6,122,851	5,758,066	-6.0%	-364,785
PROF	4,315,503	3,033,535	2,981,915	3,822,470	4,039,868	3,609,740	-10.6%	-430,128
UTIL	2,342,091	2,268,420	2,465,984	2,877,552	3,359,512	3,078,255	-8.4%	-281,257
MANU	2,743,950	3,274,410	4,227,714	4,001,614	6,547,334	3,009,881	-54.0%	-3,537,453
TRAN	1,428,440	1,561,217	1,489,707	26,830,306	26,619,197	31,230,412	17.3%	4,611,215
WHLS	5,959,126	8,489,364	15,661,772	12,971,335	13,328,084	19,864,481	49.0%	6,536,397
GOV	577,526	576,862	639,521	696,392	885,890	872,957	-1.5%	-12,933
TOTAL	68,530,671	72,498,893	167,965,637	175,237,181	162,364,815	154,344,262	-4.9%	-8,020,553

Table 3.4

For complete listing of Lines of Business, see page 13

Kenai 4th Quarter GROSS Sales History	
2002	68,530,671
2003	72,498,893
2004	167,965,637
2005	175,237,181
2006	162,364,815
2007	154,344,262

Table 3.5

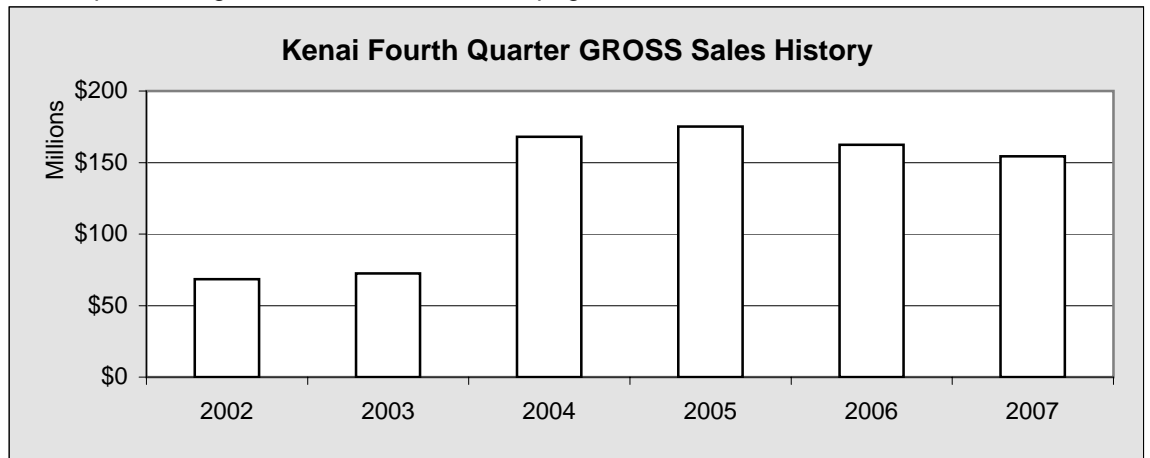

Chart 3.10

Kenai Five Year Change 4th Quarter GROSS Sales		
LOB	2002	2007
RSRC	643,831	39,570,701
SALES	32,238,060	31,130,573
CONST	5,527,590	8,094,873
PROP	4,111,208	4,627,876
TOUR	3,206,138	3,496,447
SERV	5,437,208	5,758,066
PROF	4,315,503	3,609,740
UTIL	2,342,091	3,078,255
MANU	2,743,950	3,009,881
TRAN	1,428,440	31,230,412
WHLS	5,959,126	19,864,481
GOV	577,526	872,957

Table 3.6

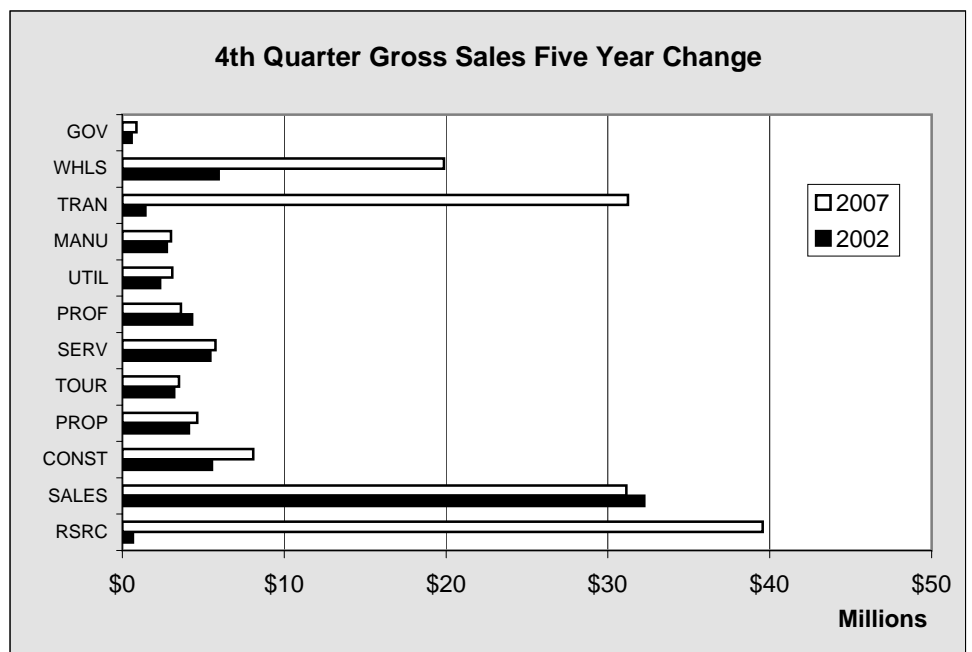

Chart 3.11

Kenai Sales

Kenai 4th Quarter TAXABLE Sales by Line of Business - 2002-2007 - in \$								
LOB	2002	2003	2004	2005	2006	2007	Annual Percent Change	Annual Amount Change
RSRC	133,622	135,724	125,523	139,023	118,901	143,911	21.0%	25,010
SALES	21,152,334	15,395,319	16,058,384	17,003,113	18,145,781	20,264,985	11.7%	2,119,204
CONST	291,379	347,623	278,619	328,337	354,544	676,354	90.8%	321,810
PROP	2,014,321	1,802,786	1,795,291	1,843,052	2,024,438	2,013,876	-0.5%	-10,562
TOUR	3,117,719	3,058,354	3,095,878	3,139,199	3,559,486	3,299,082	-7.3%	-260,404
SERV	4,183,138	3,479,581	3,328,755	3,309,977	3,713,415	3,712,072	0.0%	-1,343
PROF	592,133	594,426	656,742	617,305	580,239	548,487	-5.5%	-31,752
UTIL	1,413,514	1,429,006	1,524,338	1,696,261	1,776,054	1,667,656	-6.1%	-108,398
MANU	149,951	198,602	141,045	121,341	172,927	174,873	1.1%	1,946
TRAN	78,678	199,726	95,440	203,283	160,249	254,984	59.1%	94,735
WHLS	1,457,402	2,053,781	6,002,971	6,769,421	6,318,964	6,439,164	1.9%	120,200
GOV	390,694	383,599	432,821	464,614	488,813	519,960	6.4%	31,147
TOTAL	34,974,885	29,078,527	33,535,807	35,634,926	37,413,811	39,715,404	6.2%	2,301,593

Table 3.7

For complete listing of Lines of Business, see page 13

Kenai 4th Quarter TAXABLE Sales History	
2002	34,974,885
2003	29,078,527
2004	33,535,807
2005	35,634,926
2006	37,413,811
2007	39,715,404

Table 3.8

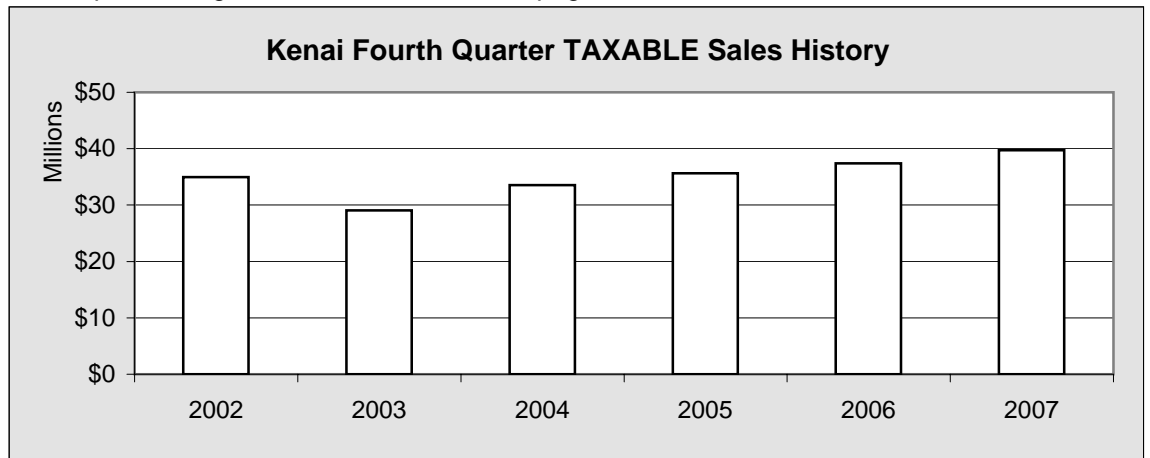

Chart 3.12

Kenai Five Year Change 4th Quarter TAXABLE Sales		
LOB	2002	2007
RSRC	133,622	143,911
SALES	21,152,334	20,264,985
CONST	291,379	676,354
PROP	2,014,321	2,013,876
TOUR	3,117,719	3,299,082
SERV	4,183,138	3,712,072
PROF	592,133	548,487
UTIL	1,413,514	1,667,656
MANU	149,951	174,873
TRAN	78,678	254,984
WHLS	1,457,402	6,439,164
GOV	390,694	519,960

Table 3.9

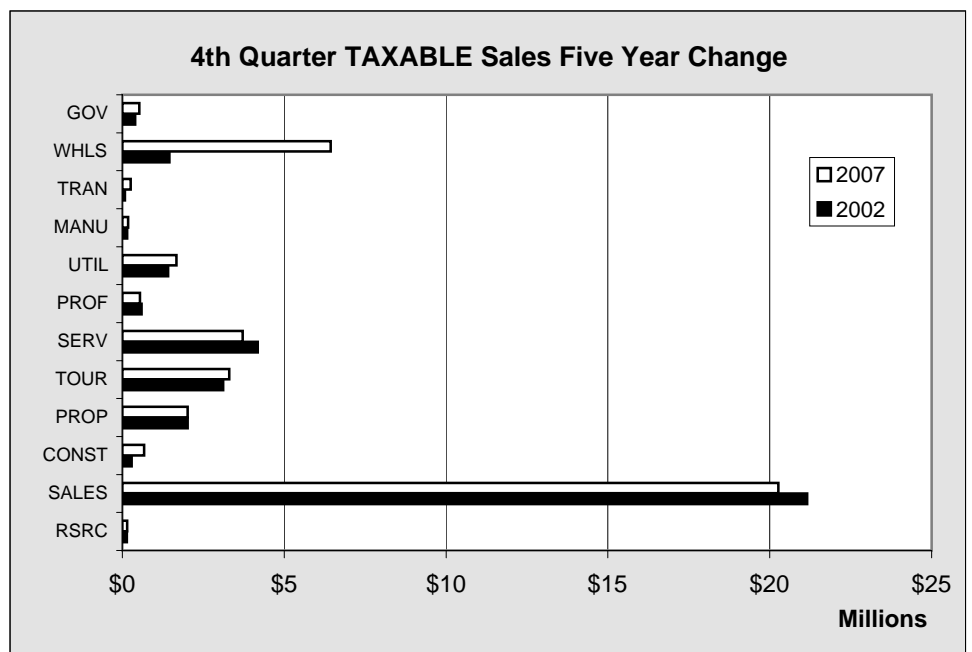

Chart 3.13

Kenai Sales

Kenai Annual GROSS Sales by Line of Business - 2002-2007 - in \$								
LOB	2002	2003	2004	2005	2006	2007	Annual Percent Change	Annual Amount Change
RSRC	4,790,032	4,922,540	100,101,620	78,876,265	43,295,377	46,727,216	7.9%	3,431,839
SALES	125,009,398	106,980,974	108,005,994	111,192,957	123,219,062	121,151,948	-1.7%	-2,067,114
CONST	18,238,159	29,962,189	13,020,172	25,425,189	40,525,053	32,875,135	-18.9%	-7,649,918
PROP	19,587,800	18,544,260	16,296,357	18,405,524	17,888,413	16,970,772	-5.1%	-917,641
TOUR	15,236,354	14,574,890	15,476,877	15,985,512	18,254,354	17,723,046	-2.9%	-531,308
SERV	20,589,118	20,611,204	19,669,162	19,639,841	21,950,777	24,372,509	11.0%	2,421,732
PROF	14,466,531	13,830,788	13,816,386	14,646,424	15,950,426	14,796,572	-7.2%	-1,153,854
UTIL	10,943,693	8,965,563	9,370,432	13,871,188	12,634,371	12,487,825	-1.2%	-146,546
MANU	17,770,220	26,455,314	26,232,173	33,432,735	29,268,746	32,503,430	11.1%	3,234,684
TRAN	5,366,315	5,449,530	18,867,382	67,972,249	75,947,180	120,521,658	58.7%	44,574,478
WHLS	24,690,263	29,926,647	63,578,072	62,846,060	53,888,047	69,597,377	29.2%	15,709,330
GOV	2,614,831	2,700,596	2,862,813	3,231,177	3,494,476	4,064,513	16.3%	570,037
TOTAL	279,302,714	282,924,495	407,297,440	465,525,121	456,316,282	513,792,001	12.6%	57,475,719

Table 3.10

For complete listing of Lines of Business, see page 13

Kenai Annual GROSS Sales History	
2002	279,302,714
2003	282,924,495
2004	407,297,440
2005	465,525,121
2006	456,316,282
2007	513,792,001

Table 3.11

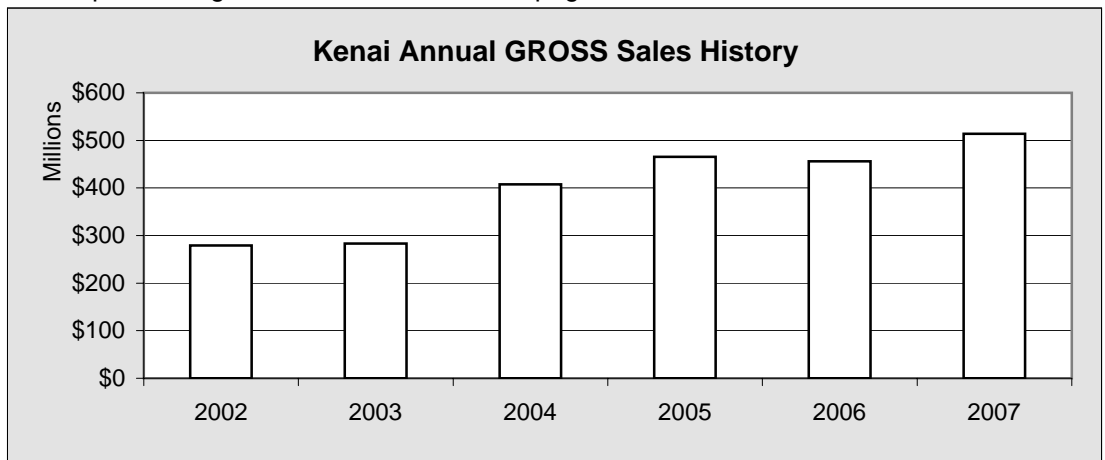

Chart 3.14

Five Year Change Annual GROSS Sales		
LOB	2002	2007
RSRC	4,790,032	46,727,216
SALES	125,009,398	121,151,948
CONST	18,238,159	32,875,135
PROP	19,587,800	16,970,772
TOUR	15,236,354	17,723,046
SERV	20,589,118	24,372,509
PROF	14,466,531	14,796,572
UTIL	10,943,693	12,487,825
MANU	17,770,220	32,503,430
TRAN	5,366,315	120,521,658
WHLS	24,690,263	69,597,377
GOV	2,614,831	4,064,513

Table 3.12

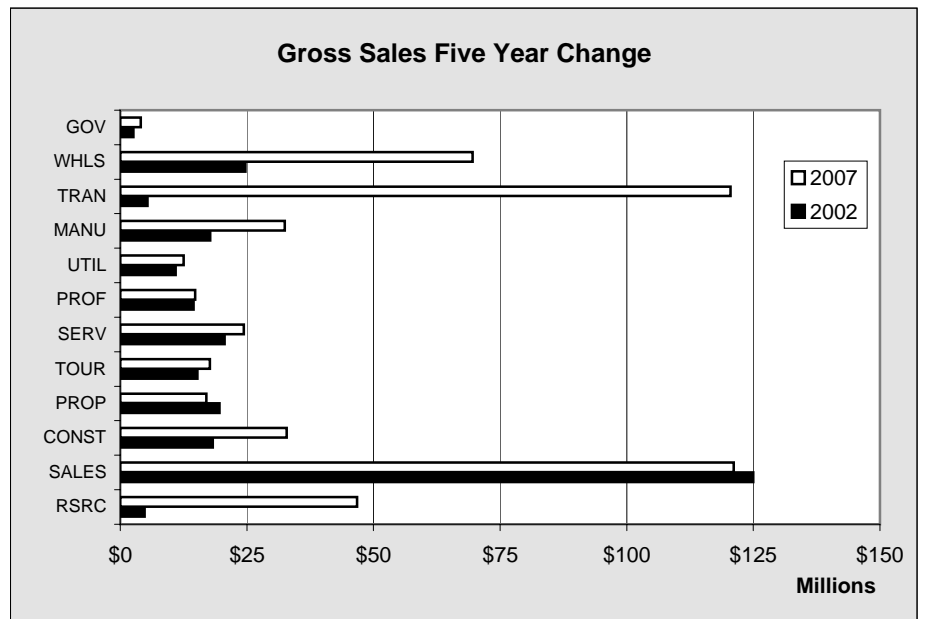

Chart 3.15

Kenai Sales

Kenai Annual TAXABLE Sales by Line of Business - 2002-2007 - in \$								
LOB	2002	2003	2004	2005	2006	2007	Annual Percent Change	Annual Amount Change
RSRC	519,195	526,395	521,830	468,010	440,218	520,505	18.2%	80,287
SALES	78,348,763	63,979,846	63,490,973	67,541,317	72,097,065	78,872,609	9.4%	6,775,544
CONST	1,135,826	1,224,679	1,188,120	1,119,387	1,185,294	1,638,685	38.3%	453,391
PROP	8,813,617	7,830,478	7,822,050	7,783,503	7,979,713	8,208,910	2.9%	229,197
TOUR	14,760,107	13,992,118	14,464,766	14,853,626	17,267,740	16,756,845	-3.0%	-510,895
SERV	15,931,501	15,902,098	14,257,405	13,379,251	14,407,881	15,868,043	10.1%	1,460,162
PROF	2,717,939	2,773,378	2,995,387	2,956,845	2,988,418	2,861,818	-4.2%	-126,600
UTIL	5,585,796	5,509,627	5,765,278	6,386,909	7,232,992	6,754,297	-6.6%	-478,695
MANU	844,835	893,384	1,057,618	1,141,546	935,795	1,033,751	10.5%	97,956
TRAN	509,961	649,899	675,440	814,711	1,070,308	1,394,918	30.3%	324,610
WHLS	5,644,891	6,336,422	25,239,822	26,564,628	28,052,741	27,661,821	-1.4%	-390,920
GOV	1,872,817	1,738,471	1,920,438	2,097,894	2,160,749	2,372,880	9.8%	212,131
TOTAL	136,685,248	121,356,795	139,399,127	145,107,627	155,818,914	163,945,082	5.2%	8,126,168

Table 3.13

For complete listing of Lines of Business, see page 13

Kenai Annual TAXABLE Sales History	
2002	136,685,248
2003	121,356,795
2004	139,399,127
2005	145,107,627
2006	155,818,914
2007	163,945,082

Table 3.14

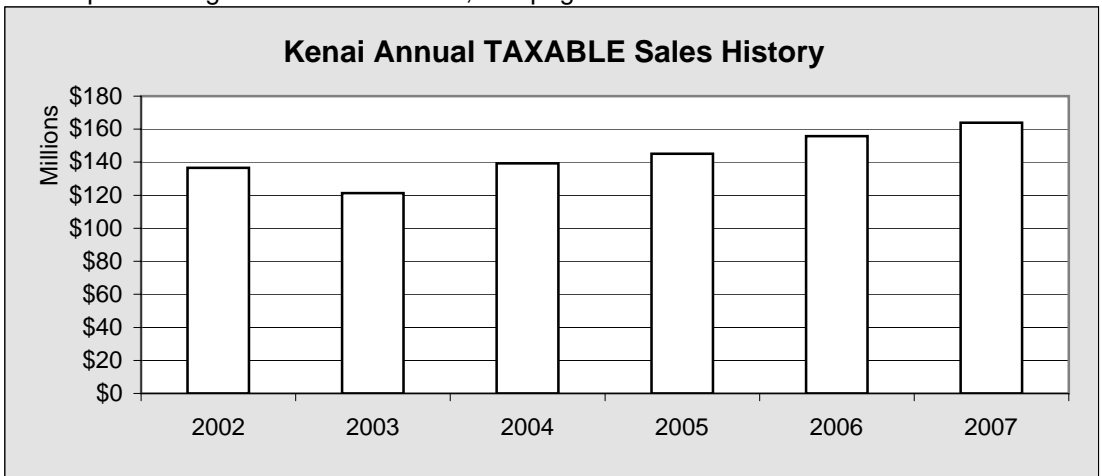

Chart 3.16

Five Year Change Annual TAXABLE Sales		
LOB	2002	2007
RSRC	519,195	520,505
SALES	78,348,763	78,872,609
CONST	1,135,826	1,638,685
PROP	8,813,617	8,208,910
TOUR	14,760,107	16,756,845
SERV	15,931,501	15,868,043
PROF	2,717,939	2,861,818
UTIL	5,585,796	6,754,297
MANU	844,835	1,033,751
TRAN	509,961	1,394,918
WHLS	5,644,891	27,661,821
GOV	1,872,817	2,372,880

Table 3.15

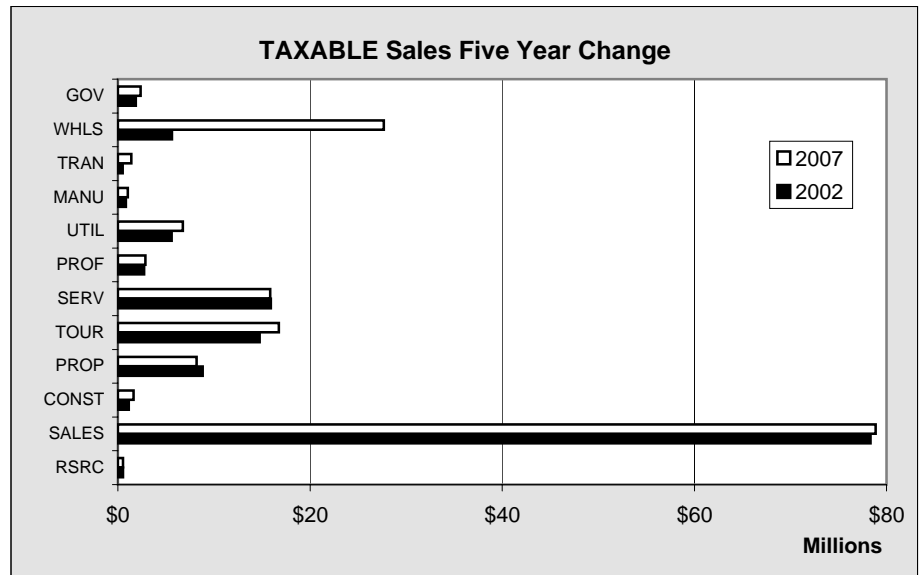

Chart 3.17

Kenai Sales

Kenai GROSS Sales by Line of Business by Quarter - 2007 - in \$

LOB	1st Quarter	2nd Quarter	3rd Quarter	4th Quarter	Total
Resource Production	664,821	2,564,489	3,927,205	39,570,701	46,727,216
Sales	25,230,608	30,849,901	33,940,866	31,130,573	121,151,948
Construction	4,581,023	7,370,002	12,829,237	8,094,873	32,875,135
Property	3,723,435	4,128,214	4,491,247	4,627,876	16,970,772
Tourism	3,301,287	4,547,135	6,378,177	3,496,447	17,723,046
Services	5,330,668	6,469,347	6,814,428	5,758,066	24,372,509
Professional	4,072,946	3,398,315	3,715,571	3,609,740	14,796,572
Utility	3,925,517	2,803,059	2,680,994	3,078,255	12,487,825
Manufacturing	4,547,604	5,843,067	19,102,878	3,009,881	32,503,430
Transportation & Warehousing	30,693,921	24,661,633	33,935,692	31,230,412	120,521,658
Wholesale	9,074,444	17,741,429	22,917,023	19,864,481	69,597,377
Government	791,264	998,930	1,401,362	872,957	4,064,513
TOTAL	95,937,538	111,375,521	152,134,680	154,344,262	513,792,001

Table 3.16

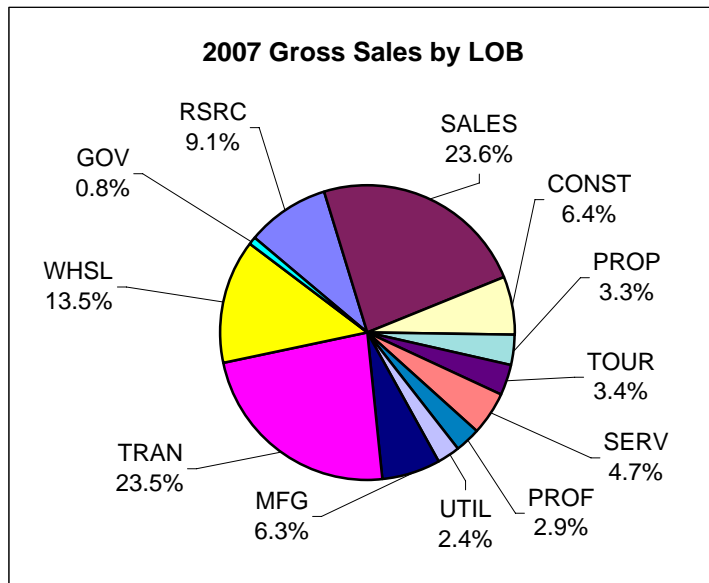

Chart 3.18

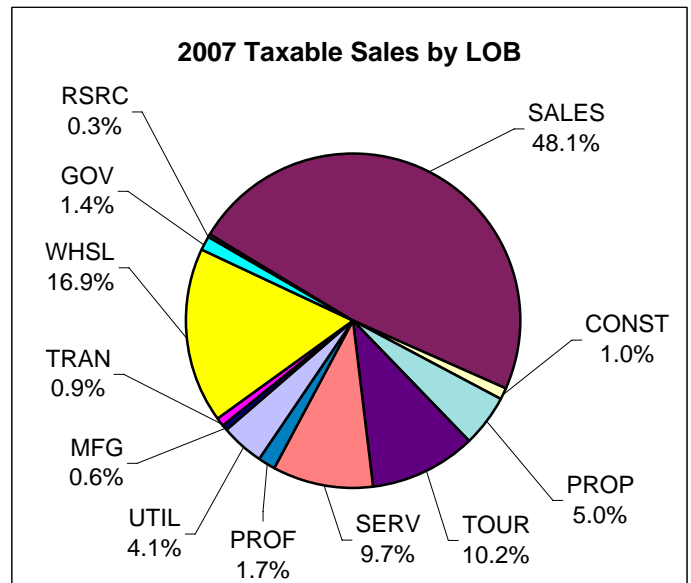

Chart 3.19

Kenai TAXABLE Sales by Line of Business by Quarter - 2007 - in \$

LOB	1st Quarter	2nd Quarter	3rd Quarter	4th Quarter	Total
Resource Production	57,569	204,307	114,718	143,911	520,505
Sales	16,299,733	19,732,949	22,574,942	20,264,985	78,872,609
Construction	265,532	327,055	369,744	676,354	1,638,685
Property	1,891,913	2,035,552	2,267,569	2,013,876	8,208,910
Tourism	3,100,426	4,353,228	6,004,109	3,299,082	16,756,845
Services	3,632,314	4,190,121	4,333,536	3,712,072	15,868,043
Professional	903,098	802,580	607,653	548,487	2,861,818
Utility	2,223,444	1,575,209	1,287,988	1,667,656	6,754,297
Manufacturing	121,285	196,958	540,635	174,873	1,033,751
Transportation & Warehousing	146,070	368,909	624,955	254,984	1,394,918
Wholesale	4,422,724	8,166,287	8,633,646	6,439,164	27,661,821
Government	495,297	546,299	811,324	519,960	2,372,880
TOTAL	33,559,405	42,499,454	48,170,819	39,715,404	163,945,082

Table 3.17

Kenai Sales

Kenai GROSS Sales by Line of Business by Quarter - 2006 - in \$					
LOB	1st Quarter	2nd Quarter	3rd Quarter	4th Quarter	Total
Resource Production	1,097,363	1,728,194	1,306,333	39,163,487	43,295,377
Sales	25,660,802	36,553,529	32,365,537	28,639,194	123,219,062
Construction	1,688,153	5,493,041	8,250,238	25,093,621	40,525,053
Property	3,583,246	4,403,064	5,045,709	4,856,394	17,888,413
Tourism	3,321,103	4,725,486	6,498,382	3,709,383	18,254,354
Services	4,847,668	5,121,473	5,858,785	6,122,851	21,950,777
Professional	3,839,598	3,730,185	4,340,775	4,039,868	15,950,426
Utility	3,940,507	2,886,141	2,448,211	3,359,512	12,634,371
Manufacturing	2,535,905	5,797,185	14,388,322	6,547,334	29,268,746
Transportation & Warehousing	2,778,466	22,737,857	23,811,660	26,619,197	75,947,180
Wholesale	9,169,811	15,264,810	16,125,342	13,328,084	53,888,047
Government	729,788	795,527	1,083,271	885,890	3,494,476
TOTAL	63,192,410	109,236,492	121,522,565	162,364,815	456,316,282

Table 3.18

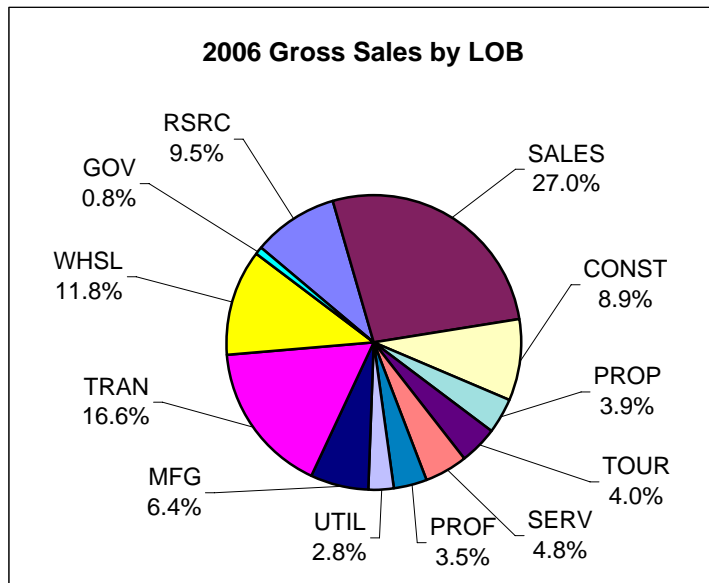

Chart 3.20

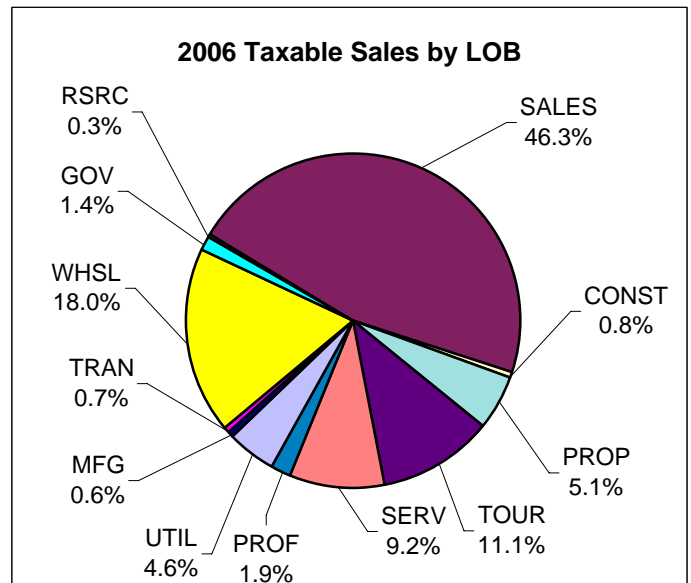

Chart 3.21

Kenai TAXABLE Sales by Line of Business by Quarter - 2006 - in \$					
LOB	1st Quarter	2nd Quarter	3rd Quarter	4th Quarter	Total
Resource Production	58,754	172,765	89,798	118,901	440,218
Sales	14,934,558	18,747,910	20,268,816	18,145,781	72,097,065
Construction	236,295	281,168	313,287	354,544	1,185,294
Property	1,749,523	1,944,002	2,261,750	2,024,438	7,979,713
Tourism	3,117,422	4,552,962	6,037,870	3,559,486	17,267,740
Services	3,415,787	3,494,366	3,784,313	3,713,415	14,407,881
Professional	874,514	848,822	684,843	580,239	2,988,418
Utility	2,403,379	1,749,039	1,304,520	1,776,054	7,232,992
Manufacturing	114,793	211,097	436,978	172,927	935,795
Transportation & Warehousing	160,941	279,014	470,104	160,249	1,070,308
Wholesale	4,737,150	8,203,295	8,793,332	6,318,964	28,052,741
Government	467,706	503,795	700,435	488,813	2,160,749
TOTAL	32,270,822	40,988,235	45,146,046	37,413,811	155,818,914

Table 3.19

Kenai Sales

Kenai GROSS Sales by Line of Business by Quarter - 2005 - in \$

LOB	1st Quarter	2nd Quarter	3rd Quarter	4th Quarter	Total
Resource Production	1,517,136	580,847	2,652,861	74,125,421	78,876,265
Sales	23,399,065	28,214,824	30,132,184	29,446,884	111,192,957
Construction	2,064,235	6,899,419	10,296,220	6,165,315	25,425,189
Property	3,434,997	3,889,087	4,976,020	6,105,420	18,405,524
Tourism	2,838,569	4,028,488	5,844,750	3,273,705	15,985,512
Services	4,423,351	5,137,398	5,158,325	4,920,767	19,639,841
Professional	4,225,118	3,087,948	3,510,888	3,822,470	14,646,424
Utility	3,496,772	2,424,732	5,072,132	2,877,552	13,871,188
Manufacturing	2,930,608	4,701,193	21,799,320	4,001,614	33,432,735
Transportation & Warehousing	14,831,365	24,047,836	2,262,742	26,830,306	67,972,249
Wholesale	11,756,319	18,746,329	19,372,077	12,971,335	62,846,060
Government	641,805	689,895	1,203,085	696,392	3,231,177
TOTAL	75,559,340	102,447,996	112,280,604	175,237,181	465,525,121

Table 3.20

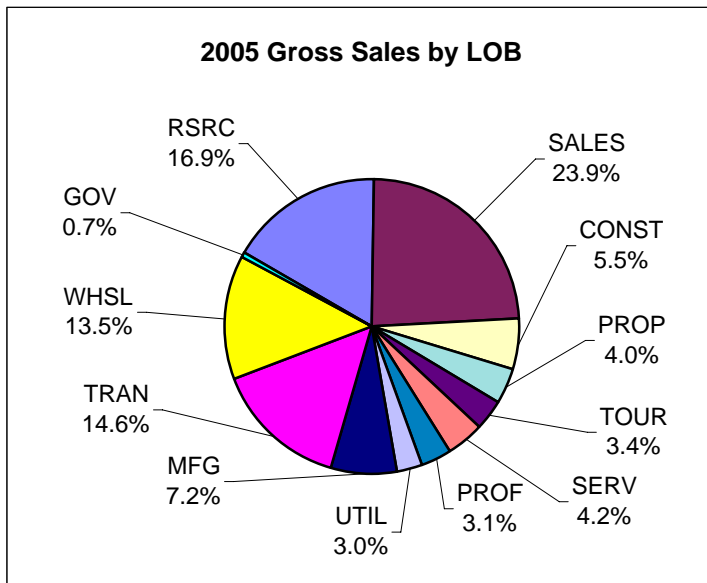

Chart 3.22

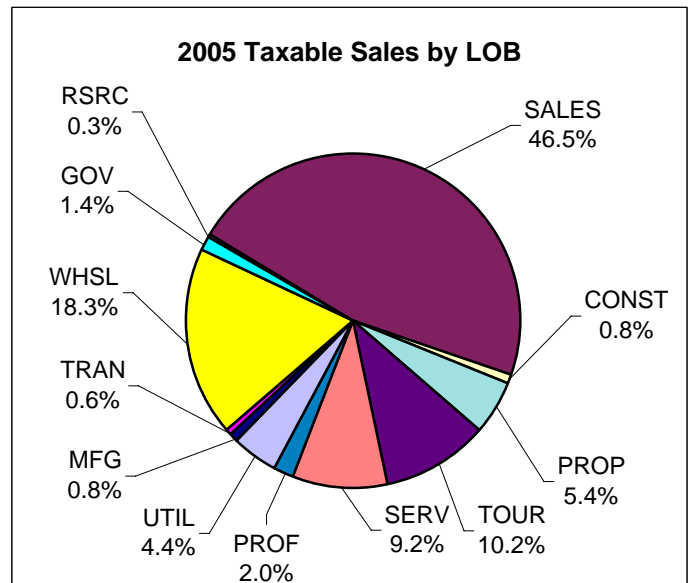

Chart 3.23

Kenai TAXABLE Sales by Line of Business by Quarter - 2005 - in \$

LOB	1st Quarter	2nd Quarter	3rd Quarter	4th Quarter	Total
Resource Production	75,510	173,152	80,325	139,023	468,010
Sales	13,949,671	17,192,039	19,396,494	17,003,113	67,541,317
Construction	220,307	320,715	250,028	328,337	1,119,387
Property	1,738,031	1,809,235	2,393,185	1,843,052	7,783,503
Tourism	2,685,045	3,750,124	5,279,258	3,139,199	14,853,626
Services	3,094,573	3,313,149	3,661,552	3,309,977	13,379,251
Professional	876,959	792,805	669,776	617,305	2,956,845
Utility	2,036,208	1,469,845	1,184,595	1,696,261	6,386,909
Manufacturing	96,472	194,451	729,282	121,341	1,141,546
Transportation & Warehousing	71,209	160,310	379,909	203,283	814,711
Wholesale	4,246,981	7,776,735	7,771,491	6,769,421	26,564,628
Government	413,946	450,679	768,655	464,614	2,097,894
TOTAL	29,504,912	37,403,239	42,564,550	35,634,926	145,107,627

Table 3.21

Kenai Construction Permits

Kenai 4th Quarter Permit VALUES by Type - 2001-2007 - in \$

	2001	2002	2003	2004	2005	2006	2007	Annual Change
Residential New	324,000	377,000	779,000	482,000	946,000	1,334,000	0	-100.0%
Residential Alter/Add	67,800	70,000	183,000	27,000	78,500	26,700	32,700	22.5%
Commercial New	214,000	990,000	253,000	0	128,000	375,000	0	-100.0%
Commercial Alter/Add	49,500	90,800	1,240,500	76,400	67,500	52,200	407,000	679.7%
Total	655,300	1,527,800	2,455,500	585,400	1,220,000	1,787,900	439,700	-75.4%
Annual Change		133.1%	60.7%	-76.2%	108.4%	46.5%	-75.4%	

Table 3.22

Kenai 4th Quarter Permit VALUES by Type - 1986-2007

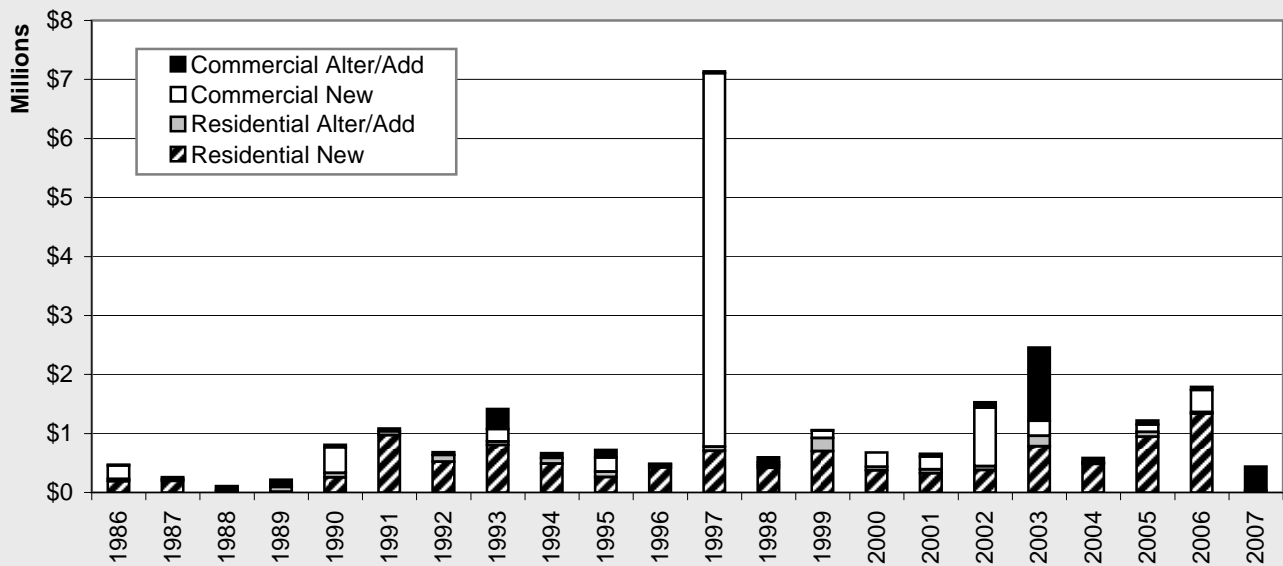

Chart 3.24

Kenai 4th Quarter Permit VALUES Percent by Type - 2007

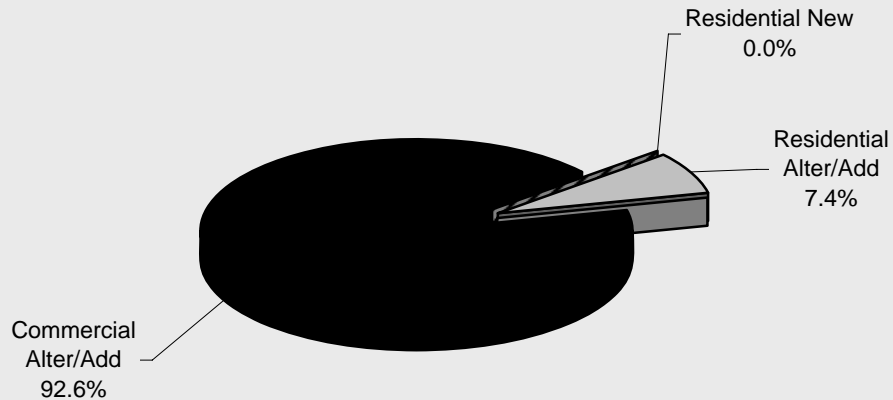

Chart 3.25

Kenai Construction Permits

Kenai 4th Quarter Permit VOLUME by Type - 2001-2007								
	2001	2002	2003	2004	2005	2006	2007	Annual Change
Residential New	2	3	6	4	5	5	0	-100.0%
Residential Alter/Add	5	4	5	4	4	4	7	75.0%
Commercial New	1	3	2	0	1	1	0	-100.0%
Commercial Alter/Add	3	10	8	6	4	4	7	75.0%
Total	11	20	21	14	14	14	14	0.0%
Annual Change		81.8%	5.0%	-33.3%	0.0%	0.0%	0.0%	

Table 3.23

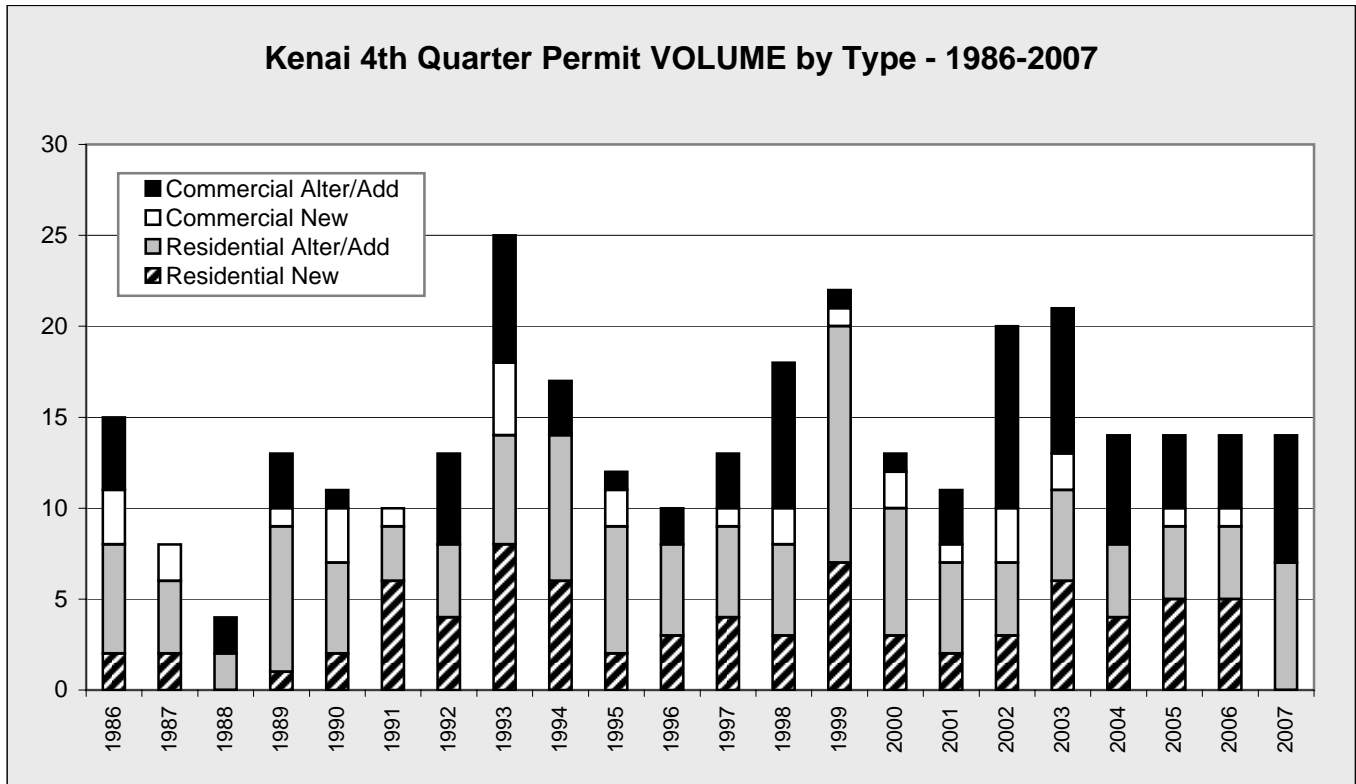

Chart 3.26

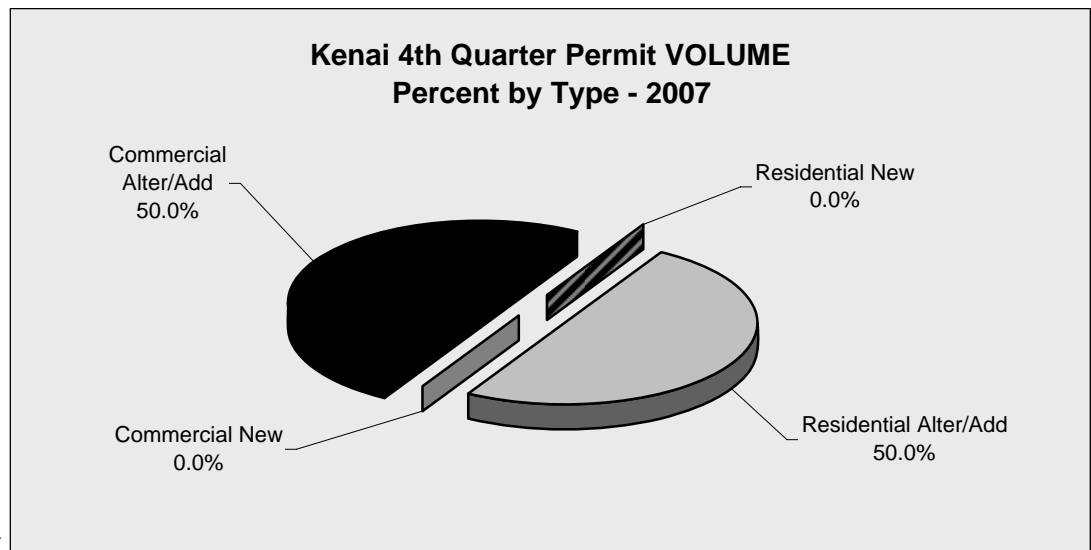

Chart 3.27

Kenai Construction Permits

Kenai ANNUAL Permit VALUES by Type - 2001-2007 - in \$								
	2001	2002	2003	2004	2005	2006	2007	Annual Change
Residential New	4,985,000	5,917,000	3,282,000	3,058,500	4,373,500	7,419,500	5,708,500	-23.1%
Residential Alter/Add	675,100	723,500	882,050	400,150	650,900	628,554	1,501,300	138.8%
Commercial New	5,379,700	6,261,200	304,000	331,000	1,173,000	610,000	7,364,000	1107.2%
Commercial Alter/Add	2,539,100	3,897,700	5,973,750	996,900	2,040,500	2,418,100	7,824,200	223.6%
Total	13,578,900	16,799,400	10,441,800	4,786,550	8,237,900	11,076,154	22,398,000	102.2%
Annual Change		23.7%	-37.8%	-54.2%	72.1%	34.5%	102.2%	

Table 3.24

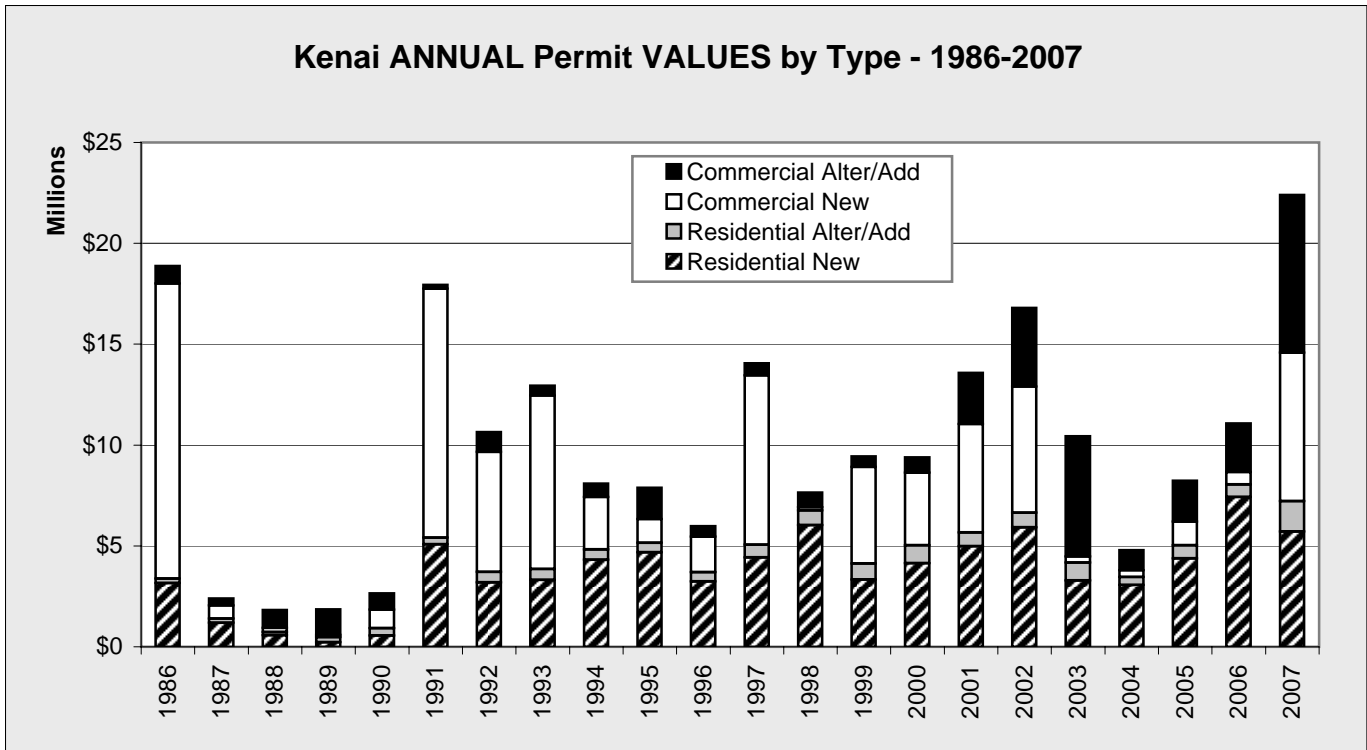

Chart 3.28

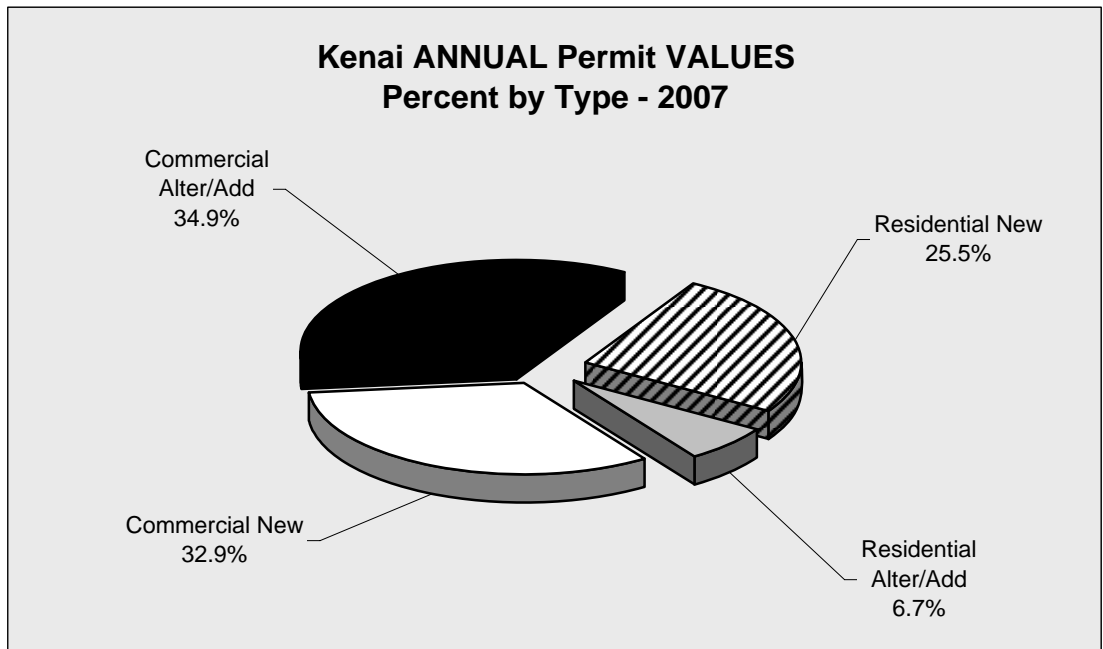

Chart 3.29

Kenai Construction Permits

Kenai ANNUAL Permit VOLUME by Type - 2001-2007

	2001	2002	2003	2004	2005	2006	2007	Annual Change
Residential New	30	42	22	20	24	37	33	-10.8%
Residential Alter/Add	31	45	44	25	36	39	51	30.8%
Commercial New	8	9	4	3	4	3	6	100.0%
Commercial Alter/Add	18	25	44	31	26	34	22	-35.3%
Total	87	121	114	79	90	113	112	-0.9%
Annual Change		39.1%	-5.8%	-30.7%	13.9%	25.6%	-0.9%	

Table 3.25

Kenai ANNUAL Permit VOLUME by Type - 1986-2007

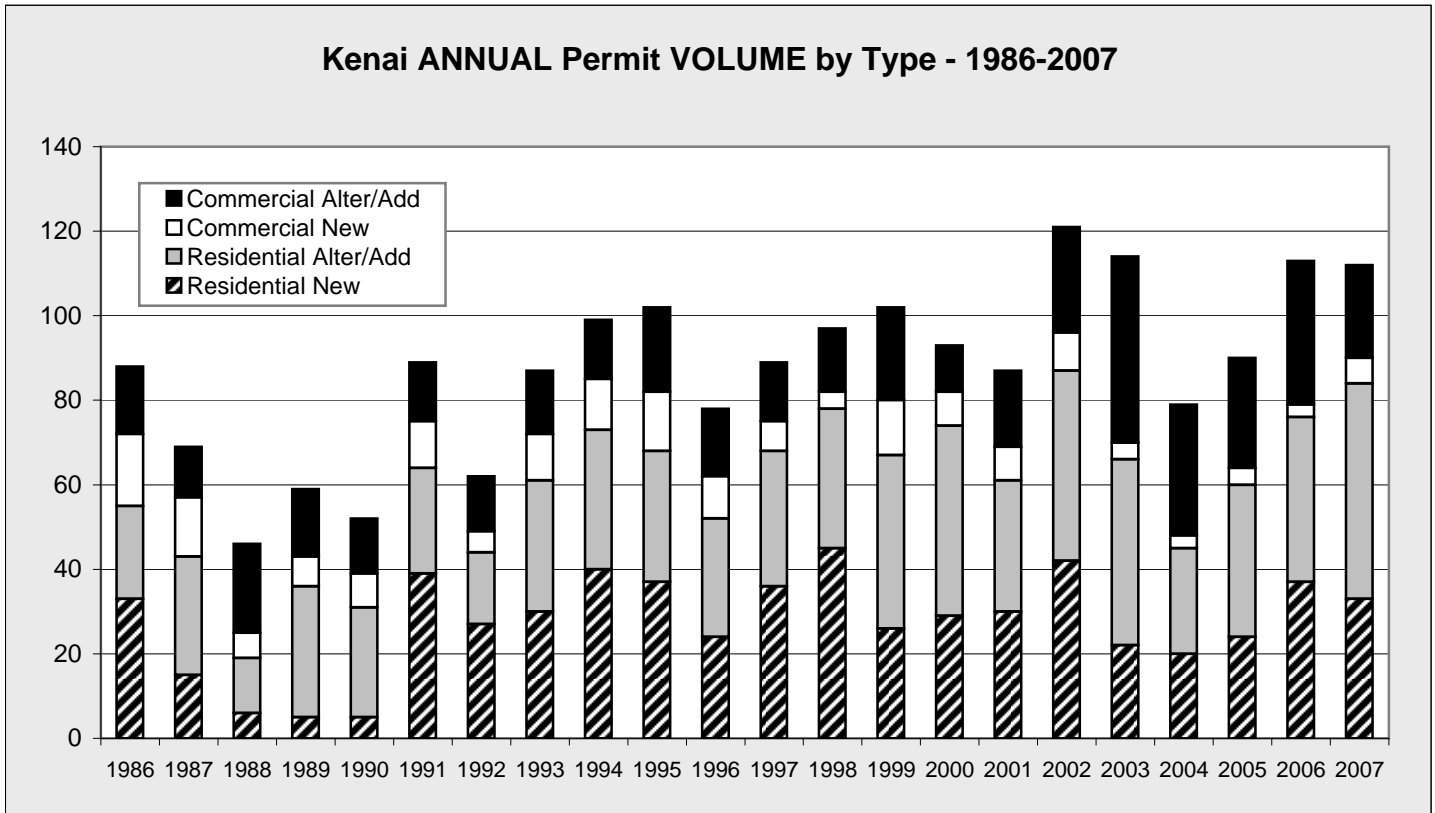

Chart 3.30

**Kenai ANNUAL Permit VOLUME
Percent by Type - 2007**

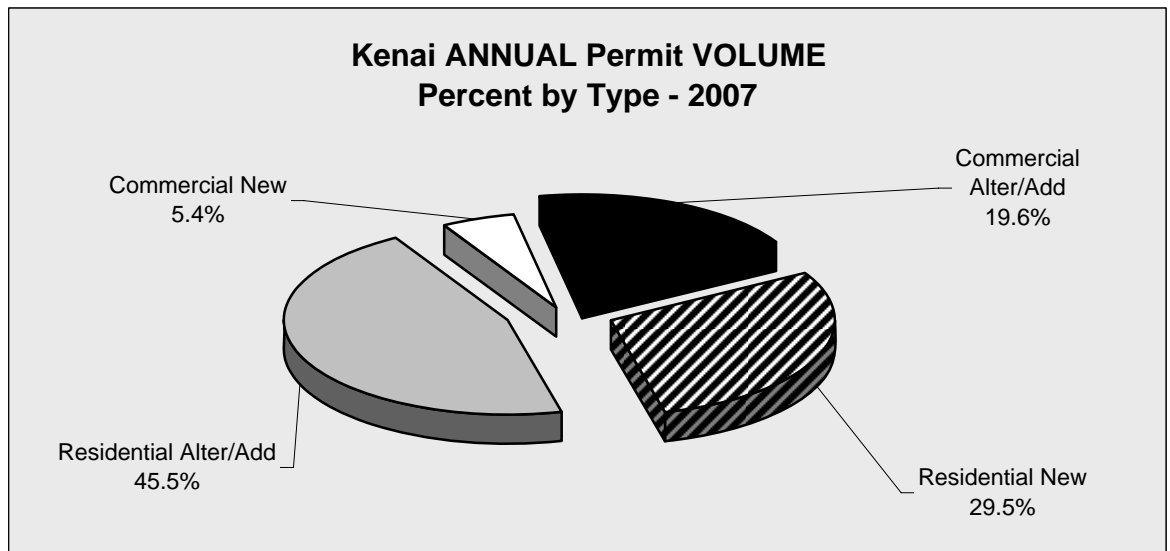

Chart 3.31

Kenai Construction Permits

Kenai Annual Permit VALUE by Type by Quarter - 2000-2007 - in \$					
	1st Quarter	2nd Quarter	3rd Quarter	4th Quarter	Total
2000					
Residential - New	228,000	2,242,000	1,287,000	376,000	4,133,000
Residential - Add/Alter	7,000	439,000	387,000	55,400	888,400
Commercial - New	65,000	409,000	2,896,000	244,000	3,614,000
Commercial - Add/Alter	162,900	73,000	524,000	2,800	762,700
TOTAL	462,900	3,163,000	5,094,000	678,200	9,398,100
2001					
Residential - New	623,000	2,886,000	1,152,000	324,000	4,985,000
Residential - Add/Alter	161,500	228,300	217,500	67,800	675,100
Commercial - New	15,000	3,744,000	1,406,700	214,000	5,379,700
Commercial - Add/Alter	20,000	739,600	1,730,000	49,500	2,539,100
TOTAL	819,500	7,597,900	4,506,200	655,300	13,578,900
2002					
Residential - New	279,000	2,362,000	2,899,000	377,000	5,917,000
Residential - Add/Alter	28,000	323,100	302,400	70,000	723,500
Commercial - New	3,579,200	1,480,000	212,000	990,000	6,261,200
Commercial - Add/Alter	2,000	404,300	3,400,600	90,800	3,897,700
TOTAL	3,888,200	4,569,400	6,814,000	1,527,800	16,799,400
2003					
Residential - New	0	1,943,000	560,000	779,000	3,282,000
Residential - Add/Alter	15,000	515,200	168,850	183,000	882,050
Commercial - New	0	0	51,000	253,000	304,000
Commercial - Add/Alter	1,542,600	270,150	2,920,500	1,240,500	5,973,750
TOTAL	1,557,600	2,728,350	3,700,350	2,455,500	10,441,800
2004					
Residential - New	300,000	1,079,000	1,197,500	482,000	3,058,500
Residential - Add/Alter	12,000	52,200	308,950	27,000	400,150
Commercial - New	0	81,000	250,000	0	331,000
Commercial - Add/Alter	0	685,200	235,300	76,400	996,900
TOTAL	312,000	1,897,400	1,991,750	585,400	4,786,550
2005					
Residential - New	0	1,883,500	1,544,000	946,000	4,373,500
Residential - Add/Alter	134,500	131,300	306,600	78,500	650,900
Commercial - New	0	45,000	1,000,000	128,000	1,173,000
Commercial - Add/Alter	291,000	497,500	1,184,500	67,500	2,040,500
TOTAL	425,500	2,557,300	4,035,100	1,220,000	8,237,900
2006					
Residential - New	378,000	3,383,000	2,324,500	1,334,000	7,419,500
Residential - Add/Alter	34,000	305,700	262,154	26,700	628,554
Commercial - New	0	60,000	175,000	375,000	610,000
Commercial - Add/Alter	351,500	408,400	1,606,000	52,200	2,418,100
TOTAL	763,500	4,157,100	4,367,654	1,787,900	11,076,154
2007					
Residential - New	527,000	3,934,500	1,247,000	0	5,708,500
Residential - Add/Alter	144,000	706,900	617,700	32,700	1,501,300
Commercial - New	0	889,000	6,475,000	0	7,364,000
Commercial - Add/Alter	98,500	637,700	6,681,000	407,000	7,824,200
TOTAL	769,500	6,168,100	15,020,700	439,700	22,398,000

Table 3.26

Kenai Construction Permits

Kenai Annual Permit VOLUME by Type by Quarter - 2000-2007					
	1st Quarter	2nd Quarter	3rd Quarter	4th Quarter	Total
2000					
Residential - New	1	14	11	3	29
Residential - Add/Alter	2	18	18	7	45
Commercial - New	1	1	4	2	8
Commercial - Add/Alter	4	3	3	1	11
TOTAL	8	36	36	13	93
2001					
Residential - New	4	16	8	2	30
Residential - Add/Alter	5	13	8	5	31
Commercial - New	1	3	3	1	8
Commercial - Add/Alter	1	10	4	3	18
TOTAL	11	42	23	11	87
2002					
Residential - New	2	18	19	3	42
Residential - Add/Alter	1	14	26	4	45
Commercial - New	1	3	2	3	9
Commercial - Add/Alter	1	2	12	10	25
TOTAL	5	37	59	20	121
2003					
Residential - New	0	13	3	6	22
Residential - Add/Alter	1	16	22	5	44
Commercial - New	0	0	2	2	4
Commercial - Add/Alter	7	11	18	8	44
TOTAL	8	40	45	21	114
2004					
Residential - New	3	5	8	4	20
Residential - Add/Alter	1	8	12	4	25
Commercial - New	0	2	1	0	3
Commercial - Add/Alter	0	15	10	6	31
TOTAL	4	30	31	14	79
2005					
Residential - New	0	11	8	5	24
Residential - Add/Alter	7	11	14	4	36
Commercial - New	0	2	1	1	4
Commercial - Add/Alter	3	9	10	4	26
TOTAL	10	33	33	14	90
2006					
Residential - New	2	16	14	5	37
Residential - Add/Alter	3	16	16	4	39
Commercial - New	0	1	1	1	3
Commercial - Add/Alter	9	9	12	4	34
TOTAL	14	42	43	14	113
2007					
Residential - New	4	17	12	0	33
Residential - Add/Alter	5	15	24	7	51
Commercial - New	0	2	4	0	6
Commercial - Add/Alter	2	9	4	7	22
TOTAL	11	43	44	14	112

Table 3.27

Seldovia Sales

Seldovia Annual Gross Sales by Quarter - in \$

	1st Quarter	2nd Quarter	3rd Quarter	4th Quarter	Total	Annual Change
1991	864,663	1,719,617	1,291,802	824,430	4,700,512	
1992	765,200	1,095,624	2,462,782	909,453	5,233,059	11.3%
1993	794,194	1,238,914	1,271,248	947,585	4,251,941	-18.7%
1994	821,959	1,395,585	1,707,670	1,350,093	5,275,307	24.1%
1995	962,895	1,802,578	1,869,108	1,203,280	5,837,861	10.7%
1996	864,931	1,406,053	2,438,766	1,020,242	5,729,992	-1.8%
1997	895,150	1,362,360	1,636,472	879,273	4,773,255	-16.7%
1998	935,674	1,331,163	1,584,201	872,701	4,723,739	-1.0%
1999	908,058	1,388,188	1,707,186	841,338	4,844,770	2.6%
2000	1,150,692	1,526,900	1,693,636	896,097	5,267,325	8.7%
2001	898,811	1,473,305	1,957,554	919,801	5,249,471	-0.3%
2002	1,011,712	1,155,055	1,694,174	956,936	4,817,877	-8.2%
2003	847,005	1,629,455	2,833,785	1,949,309	7,259,554	50.7%
2004	1,405,047	1,971,670	1,809,067	3,144,047	8,329,831	14.7%
2005	1,261,735	2,120,534	2,274,951	1,212,472	6,869,692	-17.5%
2006	1,517,120	2,169,837	2,520,816	1,354,870	7,562,643	10.1%
2007	1,466,296	2,550,151	2,090,236	3,197,313	9,303,996	23.0%
Change	-3.4%	17.5%	-17.1%	136.0%	23.0%	

Table 4.1

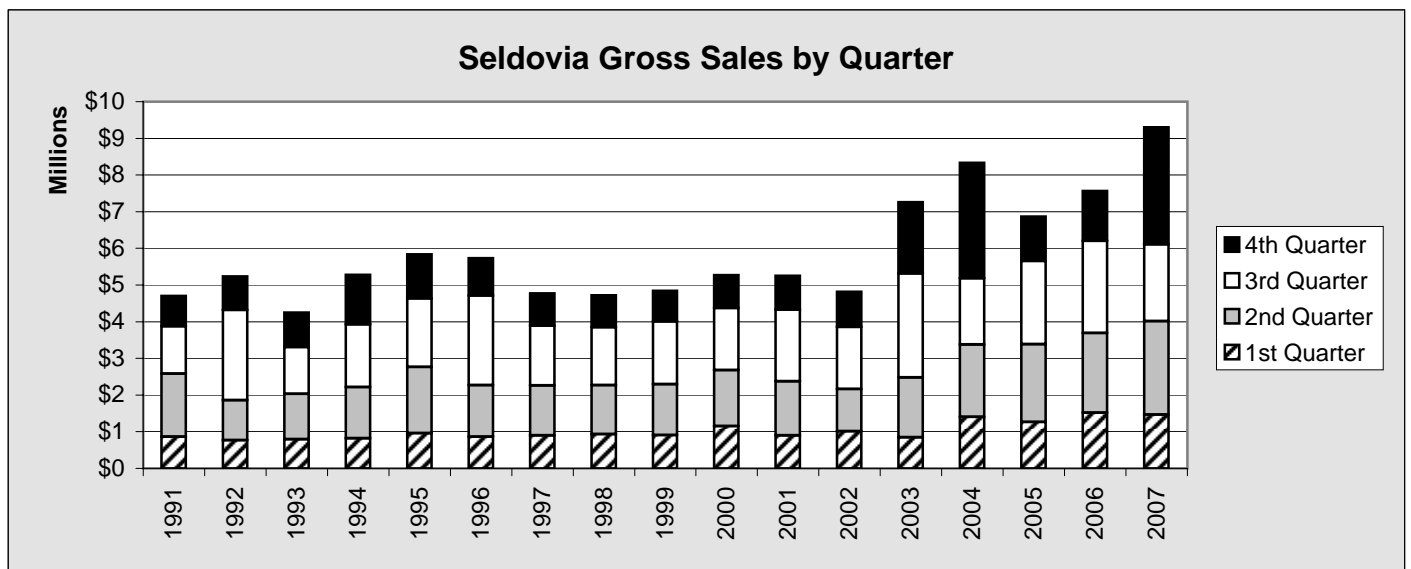

Chart 4.1

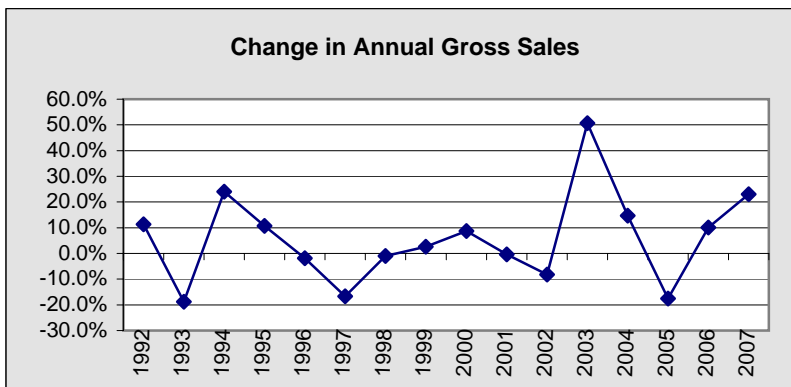

Chart 4.2

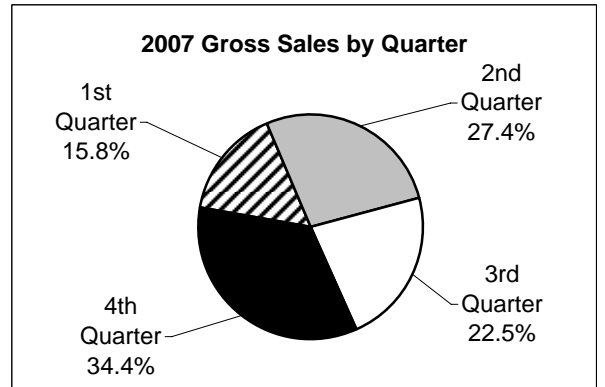

Chart 4.3

Seldovia Sales

Seldovia Annual Taxable Sales by Quarter - in \$

	1st Quarter	2nd Quarter	3rd Quarter	4th Quarter	Total	Annual Change
1991	535,765	882,434	978,212	563,892	2,960,303	
1992	537,081	827,007	1,031,257	527,040	2,922,385	-1.3%
1993	506,995	814,962	996,227	593,416	2,911,600	-0.4%
1994	551,011	868,198	1,061,682	636,294	3,117,185	7.1%
1995	602,805	981,822	1,306,693	685,628	3,576,948	14.7%
1996	578,650	996,975	1,184,616	670,068	3,430,309	-4.1%
1997	549,337	1,001,066	1,199,774	585,846	3,336,023	-2.7%
1998	529,660	1,000,949	1,251,027	616,657	3,398,293	1.9%
1999	569,438	915,962	1,144,627	599,222	3,229,249	-5.0%
2000	569,093	1,018,255	1,241,108	589,667	3,418,123	5.8%
2001	583,555	956,033	1,207,525	612,166	3,359,279	-1.7%
2002	573,624	898,830	1,191,989	607,946	3,272,389	-2.6%
2003	598,970	962,966	1,140,319	674,689	3,376,944	3.2%
2004	566,726	939,589	1,182,138	697,859	3,386,312	0.3%
2005	573,017	932,141	1,215,292	660,146	3,380,596	-0.2%
2006	636,694	973,525	1,347,778	709,060	3,667,057	8.5%
2007	756,802	1,220,055	1,515,066	779,879	4,271,802	16.5%
Change	18.9%	25.3%	12.4%	9.99%	16.5%	

Table 4.2

Seldovia Taxable Sales by Quarter

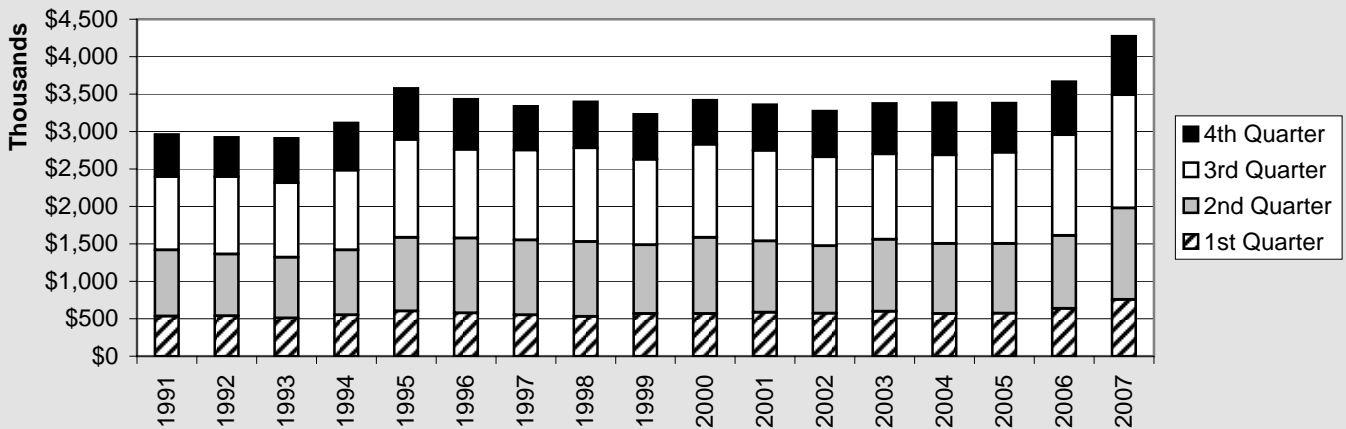

Chart 4.4

Change in Annual Taxable Sales

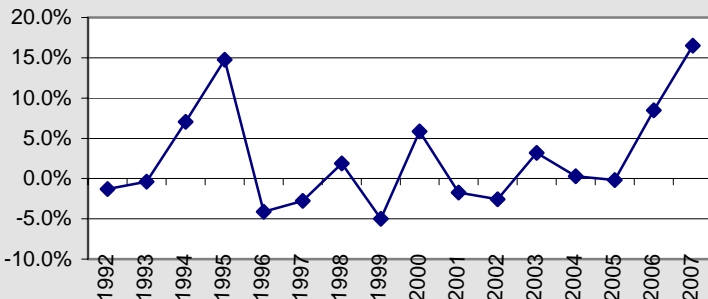

Chart 4.5

2007 Taxable Sales by Quarter

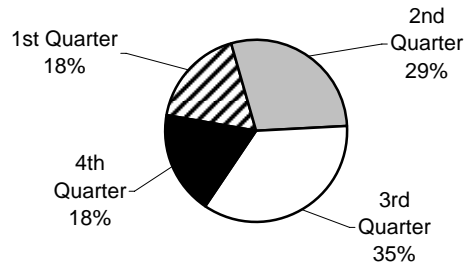

Chart 4.6

Seldovia Sales

Seldovia Annual Nontaxable Sales by Quarter - in \$

	1st Quarter	2nd Quarter	3rd Quarter	4th Quarter	Total	Annual Change
1991	328,898	837,183	313,590	260,538	1,740,209	
1992	228,119	268,617	1,431,525	382,413	2,310,674	32.8%
1993	287,199	423,952	275,021	354,169	1,340,341	-42.0%
1994	270,948	527,387	645,988	713,799	2,158,122	61.0%
1995	360,090	820,756	562,415	517,652	2,260,913	4.8%
1996	286,281	409,078	1,254,150	350,174	2,299,683	1.7%
1997	345,813	361,294	436,698	293,427	1,437,232	-37.5%
1998	406,014	330,214	333,174	256,044	1,325,446	-7.8%
1999	338,620	472,226	562,559	242,116	1,615,521	21.9%
2000	581,599	508,645	452,528	306,430	1,849,202	14.5%
2001	315,256	517,272	750,029	307,635	1,890,192	2.2%
2002	438,088	256,225	502,185	348,990	1,545,488	-18.2%
2003	248,035	666,489	1,693,466	1,274,620	3,882,610	151.2%
2004	838,321	1,032,081	626,929	2,446,188	4,943,519	27.3%
2005	688,718	1,188,393	1,059,659	552,326	3,489,096	-29.4%
2006	880,426	1,196,312	1,173,038	645,810	3,895,586	11.7%
2007	709,494	1,330,096	575,170	2,417,434	5,032,194	29.2%
Change	-19.4%	11.2%	-51.0%	274.3%	29.2%	

Table 4.3

Seldovia Nontaxable Sales by Quarter

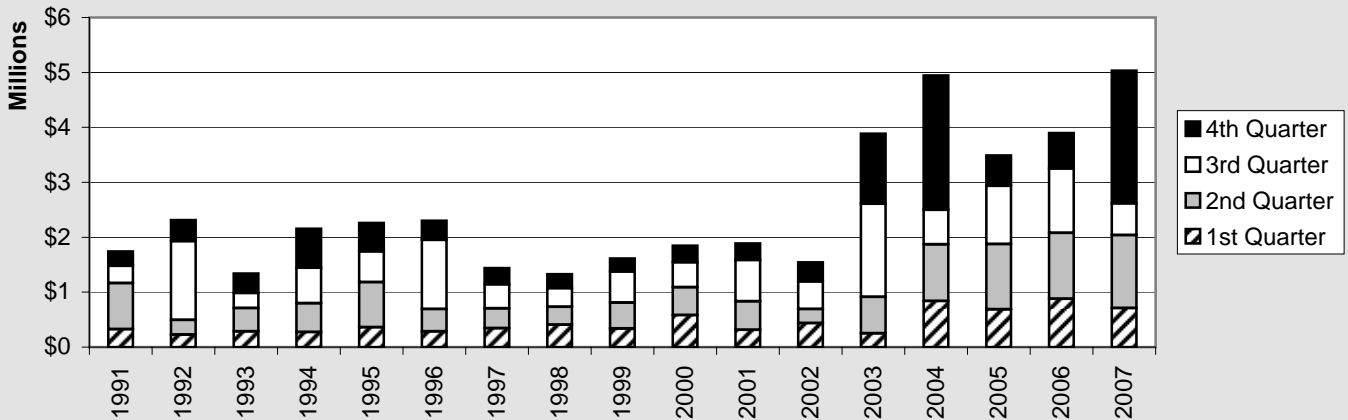

Chart 4.7

Change in Annual Nontaxable Sales

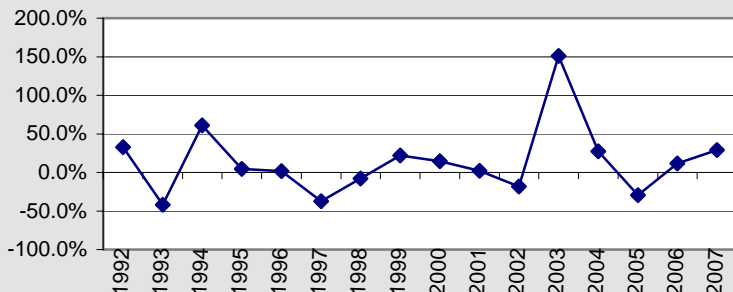

Chart 4.8

2007 Nontaxable Sales by Quarter

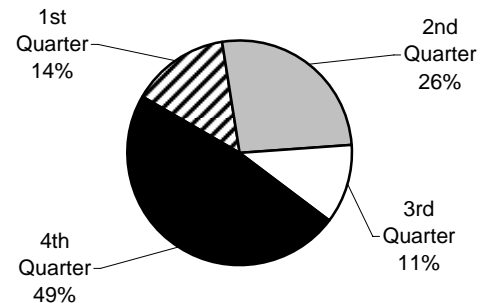

Chart 4.9

Seldovia Sales

Seldovia 4th Quarter GROSS Sales by Line of Business - 2002-2007 - in \$								
LOB	2002	2003	2004	2005	2006	2007	Annual Percent Change	Annual Amount Change
RSRC	0	0	0	0	0	0	0.0%	0
SALES	204,047	206,434	195,211	172,271	170,254	210,885	23.9%	40,631
CONST	66,691	738,842	706,248	130,496	156,311	1,762,975	1027.9%	1,606,664
PROP	59,619	264,243	1,428,624	134,165	72,801	49,214	-32.4%	-23,587
TOUR	88,514	100,887	144,931	101,301	118,546	134,690	13.6%	16,144
SERV	62,907	105,246	78,896	98,867	94,212	144,435	53.3%	50,223
PROF	30,502	80,811	64,997	13,056	115,693	144,461	24.9%	28,768
UTIL	91,439	87,134	80,244	92,681	121,919	113,235	-7.1%	-8,684
MANU	3,582	95	2,667	902	0	2,589	NA	2,589
TRAN	12,234	2,100	13,170	19,117	28,298	11,655	-58.8%	-16,643
WHLS	269,807	295,192	356,839	365,097	389,339	550,269	41.3%	160,930
GOV	67,594	68,325	72,220	84,519	87,497	72,905	-16.7%	-14,592
TOTAL	956,936	1,949,309	3,144,047	1,212,472	1,354,870	3,197,313	136.0%	1,842,443

Table 4.4

For complete listing of Lines of Business, see page 13

Seldovia 4th Quarter GROSS Sales History	
2002	956,936
2003	1,949,309
2004	3,144,047
2005	1,212,472
2006	1,354,870
2007	3,197,313

Table 4.5

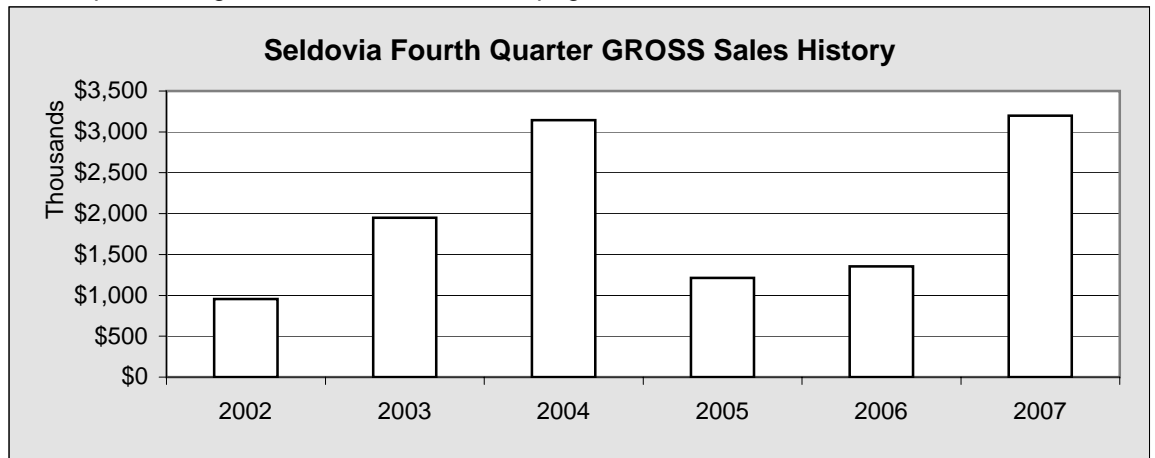

Chart 4.10

Seldovia Five Year Change 4th Quarter GROSS Sales		
LOB	2002	2007
RSRC	0	0
SALES	204,047	210,885
CONST	66,691	1,762,975
PROP	59,619	49,214
TOUR	88,514	134,690
SERV	62,907	144,435
PROF	30,502	144,461
UTIL	91,439	113,235
MANU	3,582	2,589
TRAN	12,234	11,655
WHLS	269,807	550,269
GOV	67,594	72,905

Table 4.6

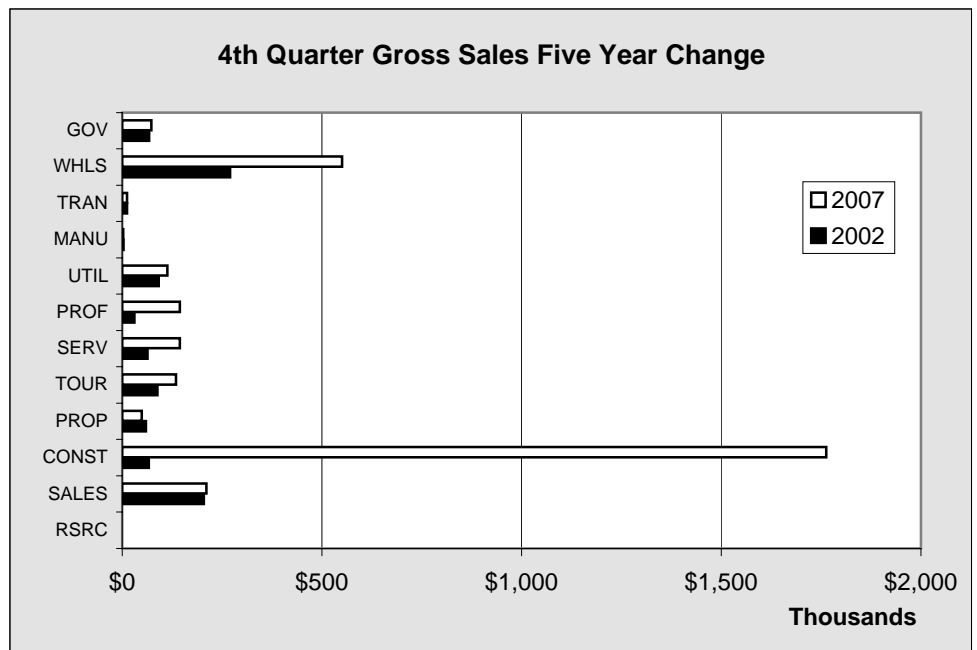

Chart 4.11

Seldovia Sales

Seldovia 4th Quarter TAXABLE Sales by Line of Business - 2002-2007 - in \$								
LOB	2002	2003	2004	2005	2006	2007	Annual Percent Change	Annual Amount Change
RSRC	0	0	0	0	0	0	0.0%	0
SALES	176,642	176,680	163,534	150,159	150,789	189,081	25.4%	38,292
CONST	1,492	9,371	6,350	9,132	7,079	12,774	80.4%	5,695
PROP	4,555	10,953	24,742	12,436	36,488	10,238	-71.9%	-26,250
TOUR	84,324	95,247	143,751	98,088	105,665	124,013	17.4%	18,348
SERV	62,005	96,290	55,498	74,243	70,463	77,199	9.6%	6,736
PROF	3,521	2,350	6,973	8,659	20,167	8,188	-59.4%	-11,979
UTIL	50,572	48,652	43,696	54,603	70,390	64,014	-9.1%	-6,376
MANU	1,482	0	2,079	102	0	1,057	NA	1,057
TRAN	5,093	1,000	3,195	3,630	6,102	3,000	-50.8%	-3,102
WHLS	159,119	165,821	184,328	198,130	188,842	245,121	29.8%	56,279
GOV	59,141	68,325	63,713	50,964	53,075	45,194	-14.8%	-7,881
TOTAL	607,946	674,689	697,859	660,146	709,060	779,879	10.0%	70,819

Table 4.7 For complete listing of Lines of Business, see page 13

Seldovia 4th Quarter TAXABLE Sales History	
2002	607,946
2003	674,689
2004	697,859
2005	660,146
2006	709,060
2007	779,879

Table 4.8

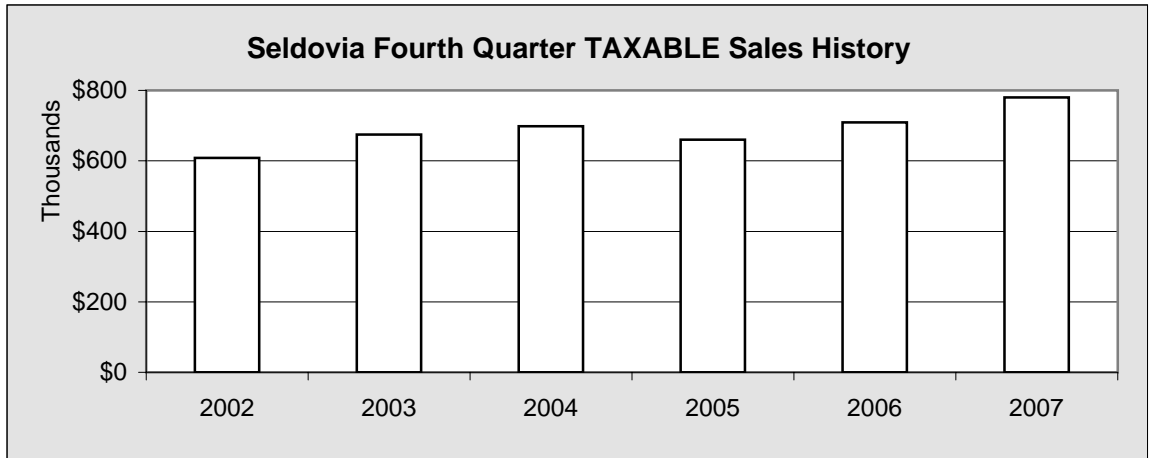

Chart 4.12

Seldovia Five Year Change 4th Quarter TAXABLE Sales		
LOB	2002	2007
RSRC	0	0
SALES	176,642	189,081
CONST	1,492	12,774
PROP	4,555	10,238
TOUR	84,324	124,013
SERV	62,005	77,199
PROF	3,521	8,188
UTIL	50,572	64,014
MANU	1,482	1,057
TRAN	5,093	3,000
WHLS	159,119	245,121
GOV	59,141	45,194

Table 4.9

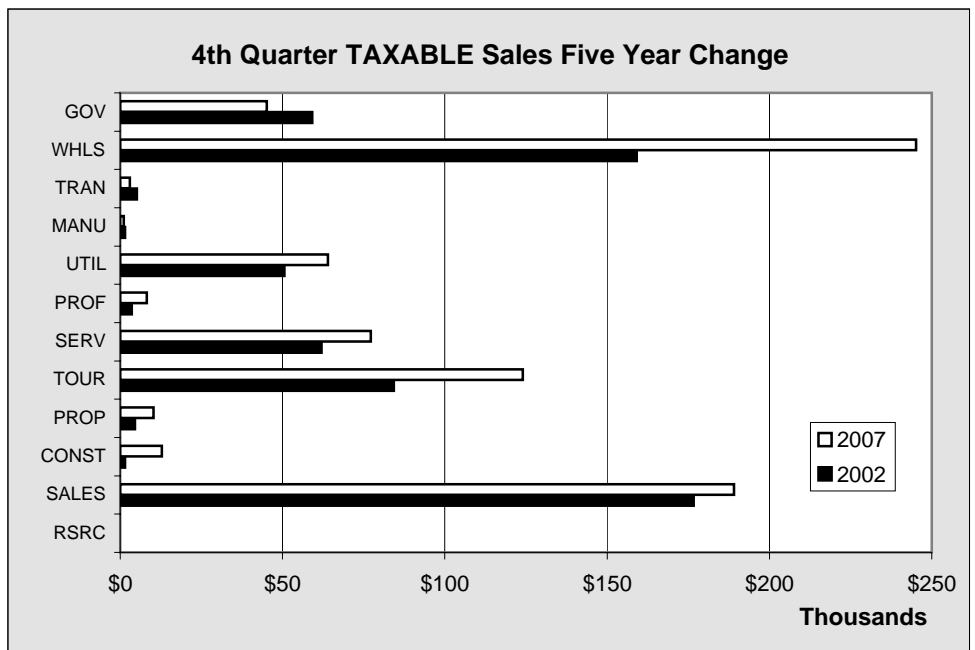

Chart 4.13

Seldovia Sales

Seldovia Annual GROSS Sales by Line of Business - 2002-2007 - in \$								
LOB	2002	2003	2004	2005	2006	2007	Annual Percent Change	Annual Amount Change
RSRC	0	0	0	0	0	25	0.0%	25
SALES	976,457	991,702	996,391	864,093	847,735	1,002,680	18.3%	154,945
CONST	264,558	2,241,387	2,431,728	1,482,392	1,030,138	2,832,701	175.0%	1,802,563
PROP	466,665	621,229	1,463,127	806,361	1,326,382	101,847	-92.3%	-1,224,535
TOUR	869,045	884,255	776,149	846,903	1,050,110	1,232,007	17.3%	181,897
SERV	228,297	298,039	344,487	346,304	350,068	642,833	83.6%	292,765
PROF	102,710	202,623	92,455	40,944	155,502	435,582	180.1%	280,080
UTIL	370,397	356,192	329,763	371,471	434,915	458,186	5.4%	23,271
MANU	11,737	8,028	23,842	24,294	12,259	11,163	-8.9%	-1,096
TRAN	224,878	205,819	264,611	289,778	354,512	318,549	-10.1%	-35,963
WHLS	1,047,098	1,174,485	1,306,023	1,486,381	1,598,598	1,907,702	19.3%	309,104
GOV	256,035	275,795	301,255	310,771	402,424	360,721	-10.4%	-41,703
TOTAL	4,817,877	7,259,554	8,329,831	6,869,692	7,562,643	9,303,996	23.0%	1,741,353

Table 4.10

For complete listing of Lines of Business, see page 13

Seldovia Annual GROSS Sales History	
2002	4,817,877
2003	7,259,554
2004	8,329,831
2005	6,869,692
2006	7,562,643
2007	9,303,996

Table 4.11

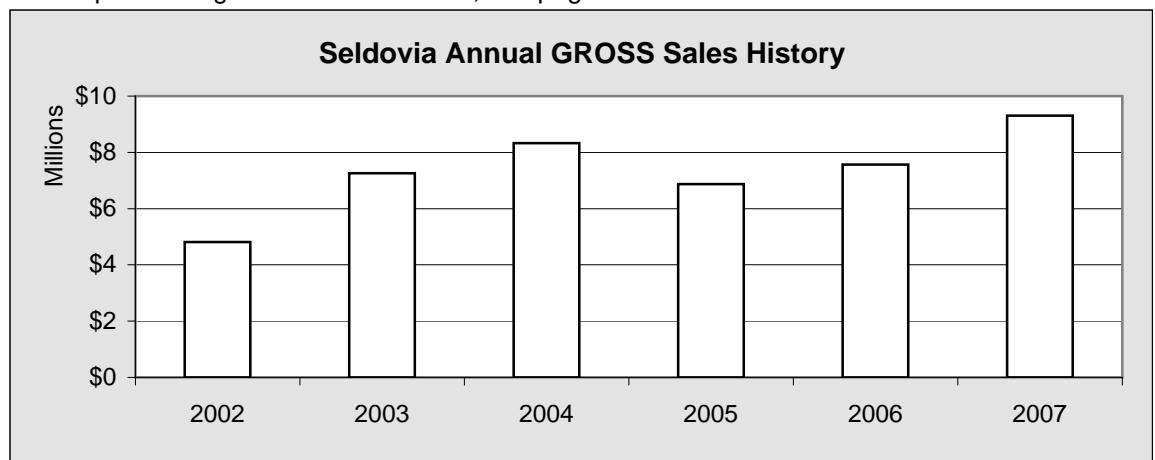

Chart 4.14

Five Year Change Annual GROSS Sales		
LOB	2002	2007
RSRC	0	25
SALES	976,457	1,002,680
CONST	264,558	2,832,701
PROP	466,665	101,847
TOUR	869,045	1,232,007
SERV	228,297	642,833
PROF	102,710	435,582
UTIL	370,397	458,186
MANU	11,737	11,163
TRAN	224,878	318,549
WHLS	1,047,098	1,907,702
GOV	256,035	360,721

Table 4.12

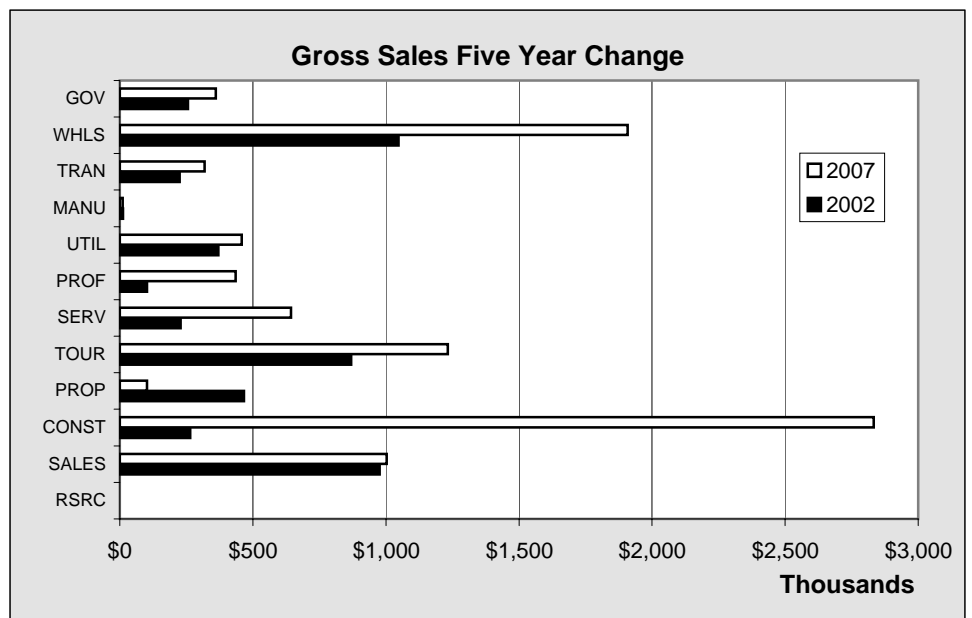

Chart 4.15

Seldovia Sales

Seldovia Annual TAXABLE Sales by Line of Business - 2002-2007 - in \$								
LOB	2002	2003	2004	2005	2006	2007	Annual Percent Change	Annual Amount Change
RSRC	0	0	0	0	0	17	0.0%	17
SALES	857,465	835,001	861,880	765,273	749,570	905,000	20.7%	155,430
CONST	23,653	29,348	26,204	29,768	34,880	35,667	2.3%	787
PROP	33,106	39,505	50,572	46,686	67,912	35,428	-47.8%	-32,484
TOUR	846,480	850,382	749,130	773,736	913,405	984,134	7.7%	70,729
SERV	220,943	257,834	231,604	239,001	254,198	446,190	75.5%	191,992
PROF	21,471	17,327	23,318	23,339	48,115	45,011	-6.5%	-3,104
UTIL	212,258	205,561	195,100	217,984	252,209	265,598	5.3%	13,389
MANU	4,445	2,027	8,636	8,788	3,230	3,849	19.2%	619
TRAN	124,822	121,847	146,351	164,217	140,752	223,734	59.0%	82,982
WHLS	706,740	766,780	856,967	880,245	930,613	1,053,419	13.2%	122,806
GOV	221,006	251,332	236,550	231,559	272,173	273,755	0.6%	1,582
TOTAL	3,272,389	3,376,944	3,386,312	3,380,596	3,667,057	4,271,802	16.5%	604,745

Table 4.13

For complete listing of Lines of Business, see page 13

Seldovia Annual TAXABLE Sales History	
2002	3,272,389
2003	3,376,944
2004	3,386,312
2005	3,380,596
2006	3,667,057
2007	4,271,802

Table 4.14

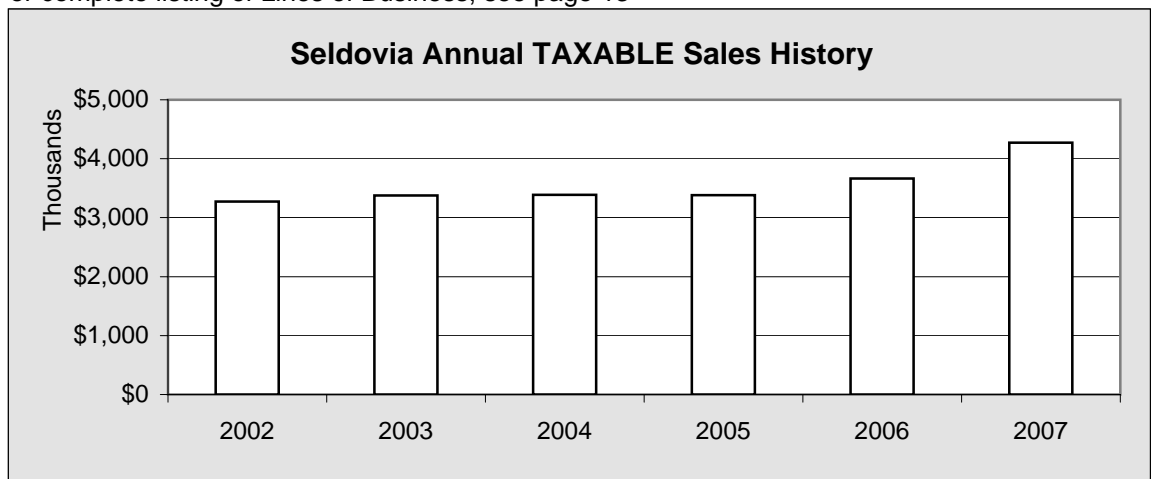

Chart 4.16

Five Year Change Annual TAXABLE Sales		
LOB	2002	2007
RSRC	0	17
SALES	857,465	905,000
CONST	23,653	35,667
PROP	33,106	35,428
TOUR	846,480	984,134
SERV	220,943	446,190
PROF	21,471	45,011
UTIL	212,258	265,598
MANU	4,445	3,849
TRAN	124,822	223,734
WHLS	706,740	1,053,419
GOV	221,006	273,755

Table 4.15

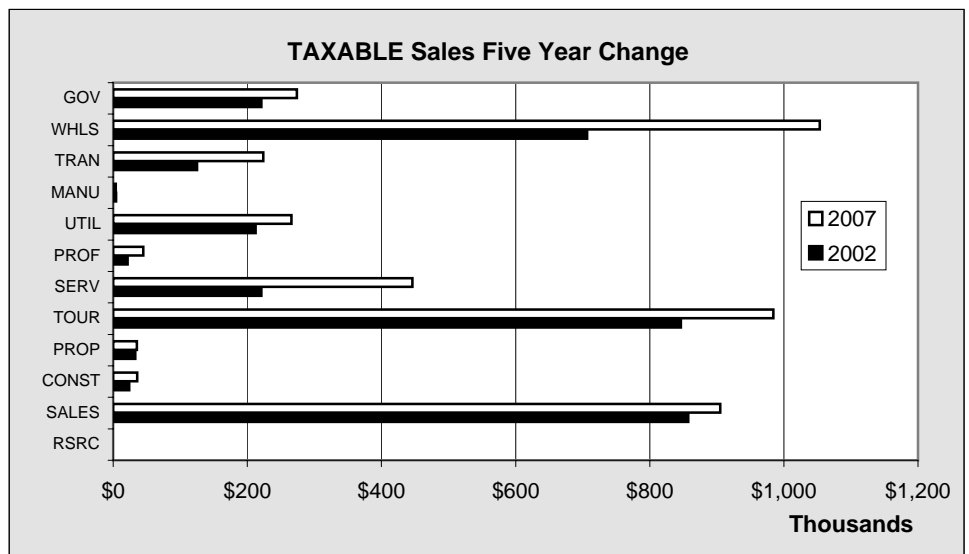

Chart 4.17

Seldovia Sales

Seldovia GROSS Sales by Line of Business by Quarter - 2007 - in \$					
LOB	1st Quarter	2nd Quarter	3rd Quarter	4th Quarter	Total
Resource Production	16	9	0	0	25
Sales	167,414	276,341	348,040	210,885	1,002,680
Construction	129,681	816,558	123,487	1,762,975	2,832,701
Property	28,082	13,260	11,291	49,214	101,847
Tourism	330,041	351,073	416,203	134,690	1,232,007
Services	90,386	193,044	214,968	144,435	642,833
Professional	51,036	139,361	100,724	144,461	435,582
Utility	125,641	101,555	117,755	113,235	458,186
Manufacturing	684	1,602	6,288	2,589	11,163
Transporation & Warehousing	237	117,605	189,052	11,655	318,549
Wholesale	415,748	463,239	478,446	550,269	1,907,702
Government	127,330	76,504	83,982	72,905	360,721
TOTAL	1,466,296	2,550,151	2,090,236	3,197,313	9,303,996

Table 4.16

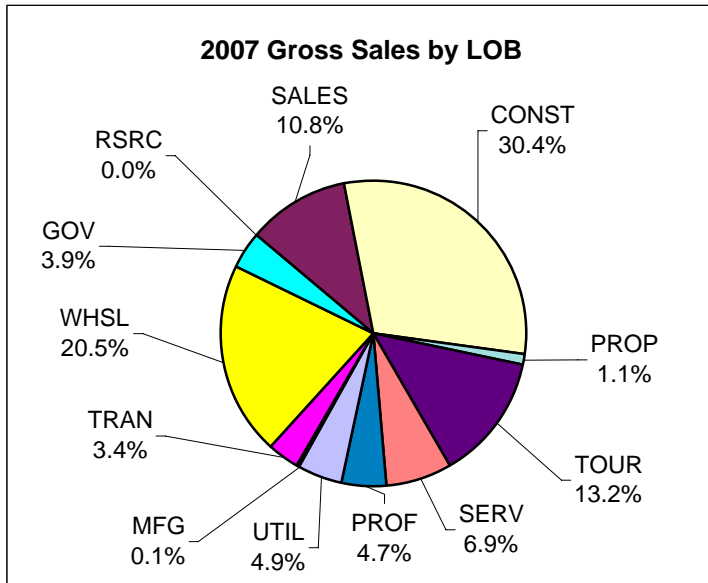

Chart 4.18

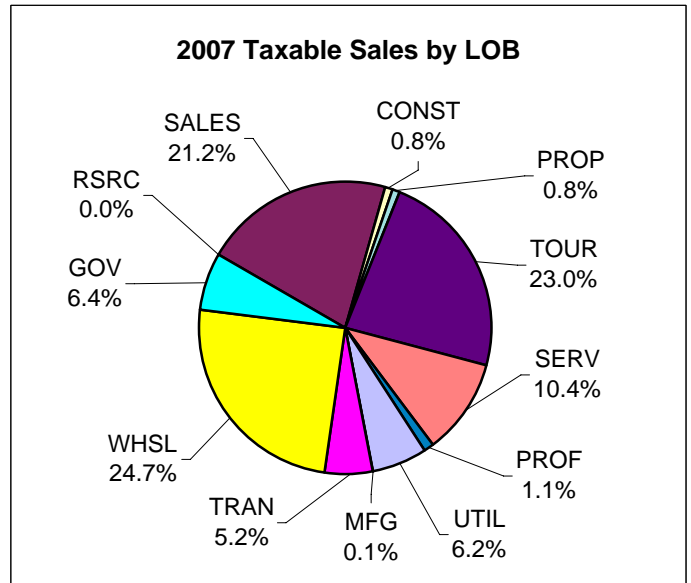

Chart 4.19

Seldovia TAXABLE Sales by Line of Business by Quarter - 2007 - in \$					
LOB	1st Quarter	2nd Quarter	3rd Quarter	4th Quarter	Total
Resource Production	16	1	0	0	17
Sales	147,999	251,916	316,004	189,081	905,000
Construction	7,431	7,079	8,383	12,774	35,667
Property	10,368	6,831	7,991	10,238	35,428
Tourism	120,309	338,552	401,260	124,013	984,134
Services	64,111	128,901	175,979	77,199	446,190
Professional	7,782	12,084	16,957	8,188	45,011
Utility	70,415	58,972	72,197	64,014	265,598
Manufacturing	619	500	1,673	1,057	3,849
Transporation & Warehousing	237	70,799	149,698	3,000	223,734
Wholesale	221,229	286,917	300,152	245,121	1,053,419
Government	106,286	57,503	64,772	45,194	273,755
TOTAL	756,802	1,220,055	1,515,066	779,879	4,271,802

Table 4.17

Seldovia Sales

Seldovia GROSS Sales by Line of Business by Quarter - 2006 - in \$					
LOB	1st Quarter	2nd Quarter	3rd Quarter	4th Quarter	Total
Resource Production	0	0	0	0	0
Sales	144,744	249,160	283,577	170,254	847,735
Construction	109,756	164,132	599,939	156,311	1,030,138
Property	419,507	573,282	260,792	72,801	1,326,382
Tourism	99,240	335,404	496,920	118,546	1,050,110
Services	77,270	84,535	94,051	94,212	350,068
Professional	7,933	13,650	18,226	115,693	155,502
Utility	119,187	98,564	95,245	121,919	434,915
Manufacturing	9,590	2,027	642	0	12,259
Transportation & Warehousing	36,307	124,452	165,455	28,298	354,512
Wholesale	375,650	418,821	414,788	389,339	1,598,598
Government	117,936	105,810	91,181	87,497	402,424
TOTAL	1,517,120	2,169,837	2,520,816	1,354,870	7,562,643

Table 4.18

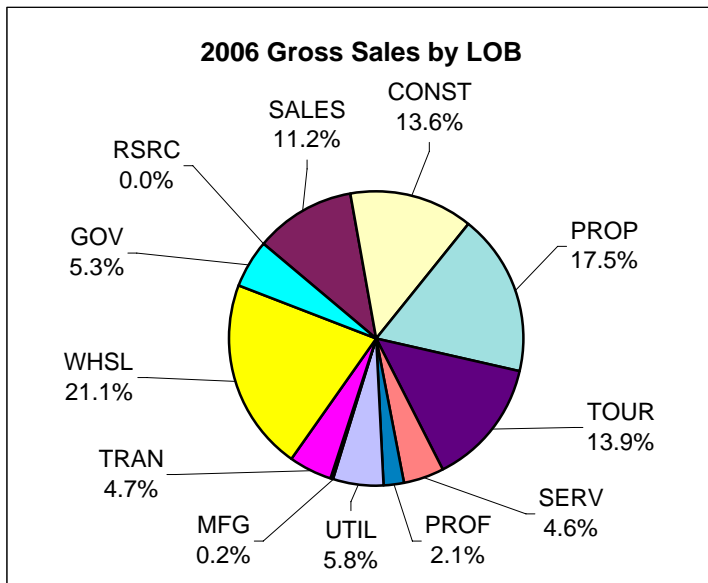

Chart 4.20

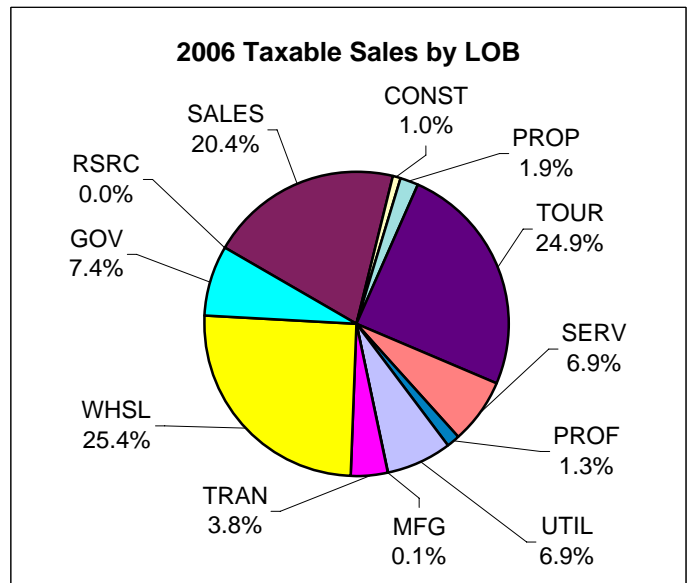

Chart 4.21

Seldovia TAXABLE Sales by Line of Business by Quarter - 2006 - in \$					
LOB	1st Quarter	2nd Quarter	3rd Quarter	4th Quarter	Total
Resource Production	0	0	0	0	0
Sales	124,028	216,749	258,004	150,789	749,570
Construction	6,985	7,858	12,958	7,079	34,880
Property	12,331	9,352	9,741	36,488	67,912
Tourism	87,219	247,458	473,063	105,665	913,405
Services	56,012	51,270	76,453	70,463	254,198
Professional	5,173	11,633	11,142	20,167	48,115
Utility	66,166	54,926	60,727	70,390	252,209
Manufacturing	2,813	27	390	0	3,230
Transportation & Warehousing	296	48,331	86,023	6,102	140,752
Wholesale	188,181	263,478	290,112	188,842	930,613
Government	87,490	62,443	69,165	53,075	272,173
TOTAL	636,694	973,525	1,347,778	709,060	3,667,057

Table 4.19

Seldovia Sales

Seldovia GROSS Sales by Line of Business by Quarter - 2005 - in \$					
LOB	1st Quarter	2nd Quarter	3rd Quarter	4th Quarter	Total
Resource Production	0	0	0	0	0
Sales	156,879	247,256	287,687	172,271	864,093
Construction	434,659	448,535	468,702	130,496	1,482,392
Property	13,621	421,243	237,332	134,165	806,361
Tourism	105,877	248,817	390,908	101,301	846,903
Services	79,092	89,641	78,704	98,867	346,304
Professional	3,704	4,509	19,675	13,056	40,944
Utility	90,417	94,395	93,978	92,681	371,471
Manufacturing	6,199	519	16,674	902	24,294
Transporation & Warehousing	354	88,970	181,337	19,117	289,778
Wholesale	303,787	395,869	421,628	365,097	1,486,381
Government	67,146	80,780	78,326	84,519	310,771
TOTAL	1,261,735	2,120,534	2,274,951	1,212,472	6,869,692

Table 4.20

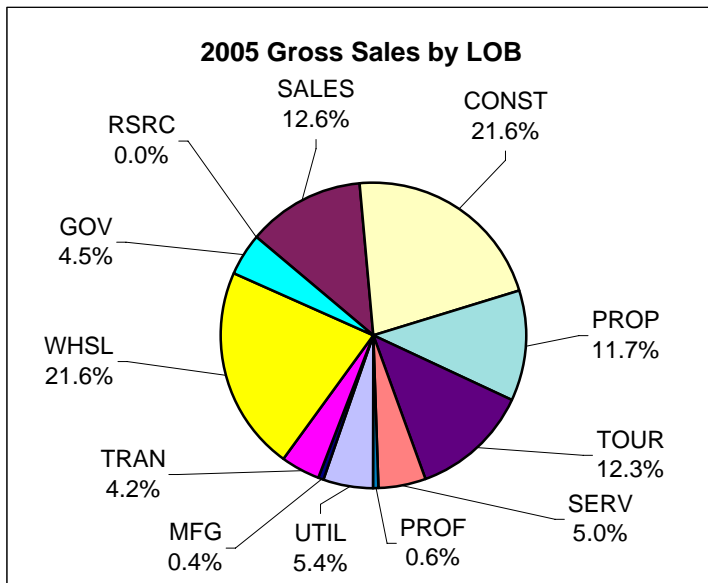

Chart 4.22

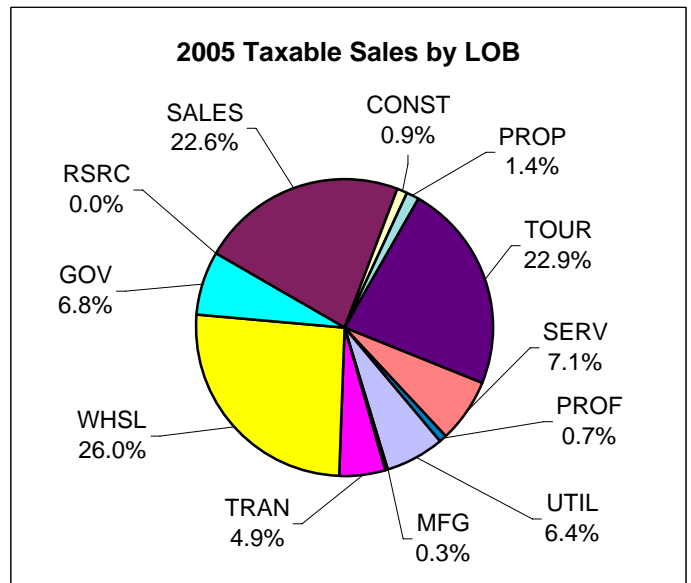

Chart 4.23

Seldovia TAXABLE Sales by Line of Business by Quarter - 2005 - in \$					
LOB	1st Quarter	2nd Quarter	3rd Quarter	4th Quarter	Total
Resource Production	0	0	0	0	0
Sales	136,588	218,035	260,491	150,159	765,273
Construction	4,655	7,615	8,366	9,132	29,768
Property	8,816	8,763	16,671	12,436	46,686
Tourism	87,511	226,325	361,812	98,088	773,736
Services	52,275	57,099	55,384	74,243	239,001
Professional	3,704	3,609	7,367	8,659	23,339
Utility	50,931	53,250	59,200	54,603	217,984
Manufacturing	5,699	107	2,880	102	8,788
Transporation & Warehousing	354	54,047	106,186	3,630	164,217
Wholesale	174,069	235,860	272,186	198,130	880,245
Government	48,415	67,431	64,749	50,964	231,559
TOTAL	573,017	932,141	1,215,292	660,146	3,380,596

Table 4.21

Seldovia Construction Permits

Seldovia 4th Quarter Permit VALUES by Type - 2001-2007 - in \$

	2001	2002	2003	2004	2005	2006	2007	Annual Change
Residential New	0	0	26,000	0	0	0	0	0
Residential Alter/Add	5,000	20,000	3,000	0	0	0	1,000	1,000
Commercial New	0	0	7,500	0	0	0	0	0
Commercial Alter/Add	10,000	0	0	0	500	18,000	0	-18,000
Total	15,000	20,000	36,500	0	500	18,000	1,000	-17,000
Annual Change		33.3%	82.5%	-100.0%	NA	3500.0%	-94.4%	

Table 4.22

Seldovia 4th Quarter Permit VALUES by Type - 1986-2007

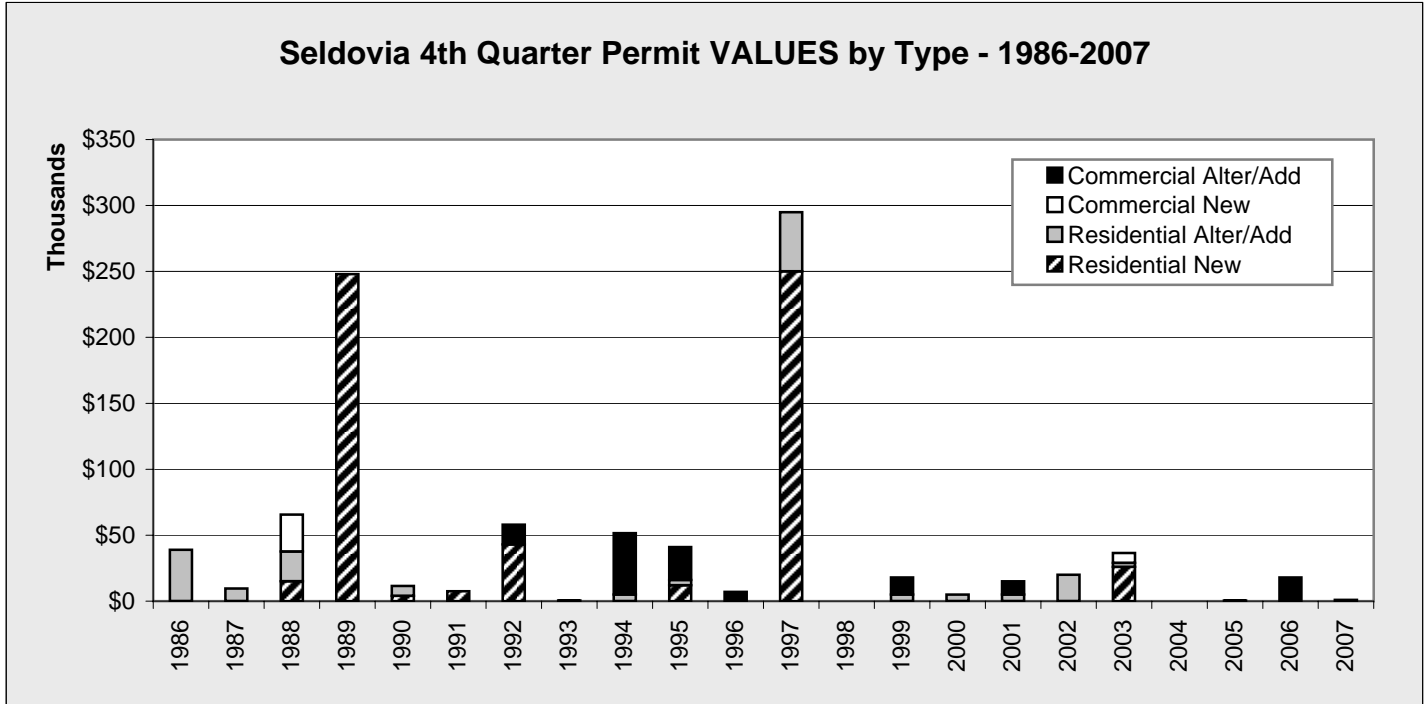

Chart 4.24

**Seldovia 4th Quarter Permit VALUES
Percent by Type - 2007**

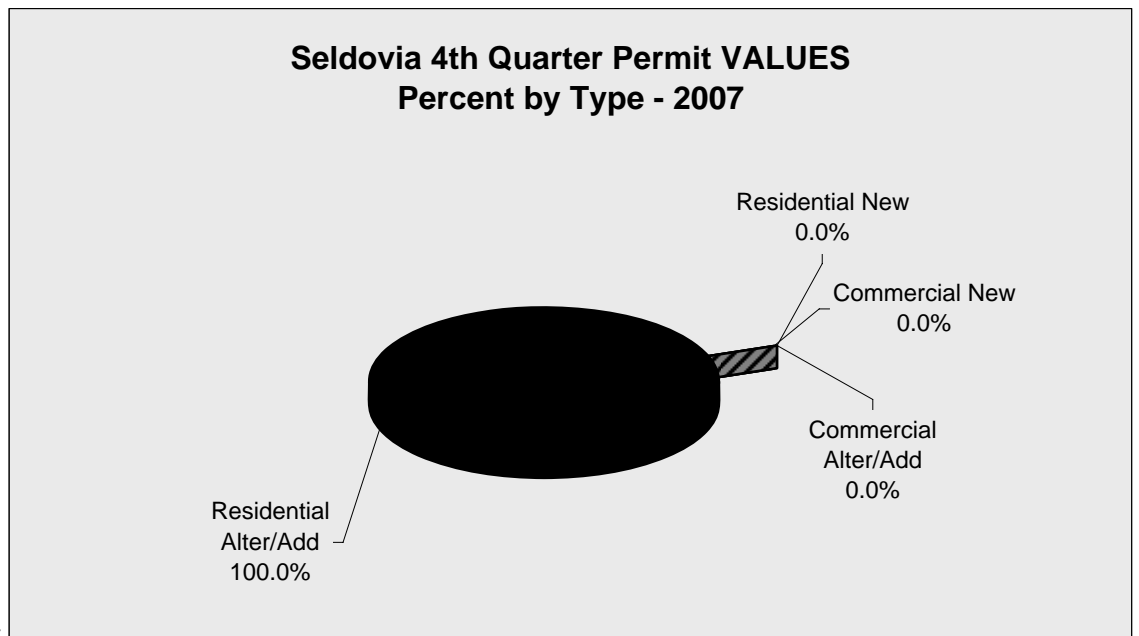

Chart 4.25

Seldovia Construction Permits

Seldovia 4th Quarter Permit VOLUME by Type - 2001-2007								
	2001	2002	2003	2004	2005	2006	2007	Annual Change
Residential New	0	0	2	0	0	0	0	0
Residential Alter/Add	1	1	1	0	0	0	1	1
Commercial New	0	0	1	0	0	0	0	0
Commercial Alter/Add	1	0	0	0	1	1	0	-1
Total	2	1	4	0	1	1	1	0
Annual Change		-50.0%	300.0%	-100.0%	NA	0.0%	0.0%	

Table 4.23

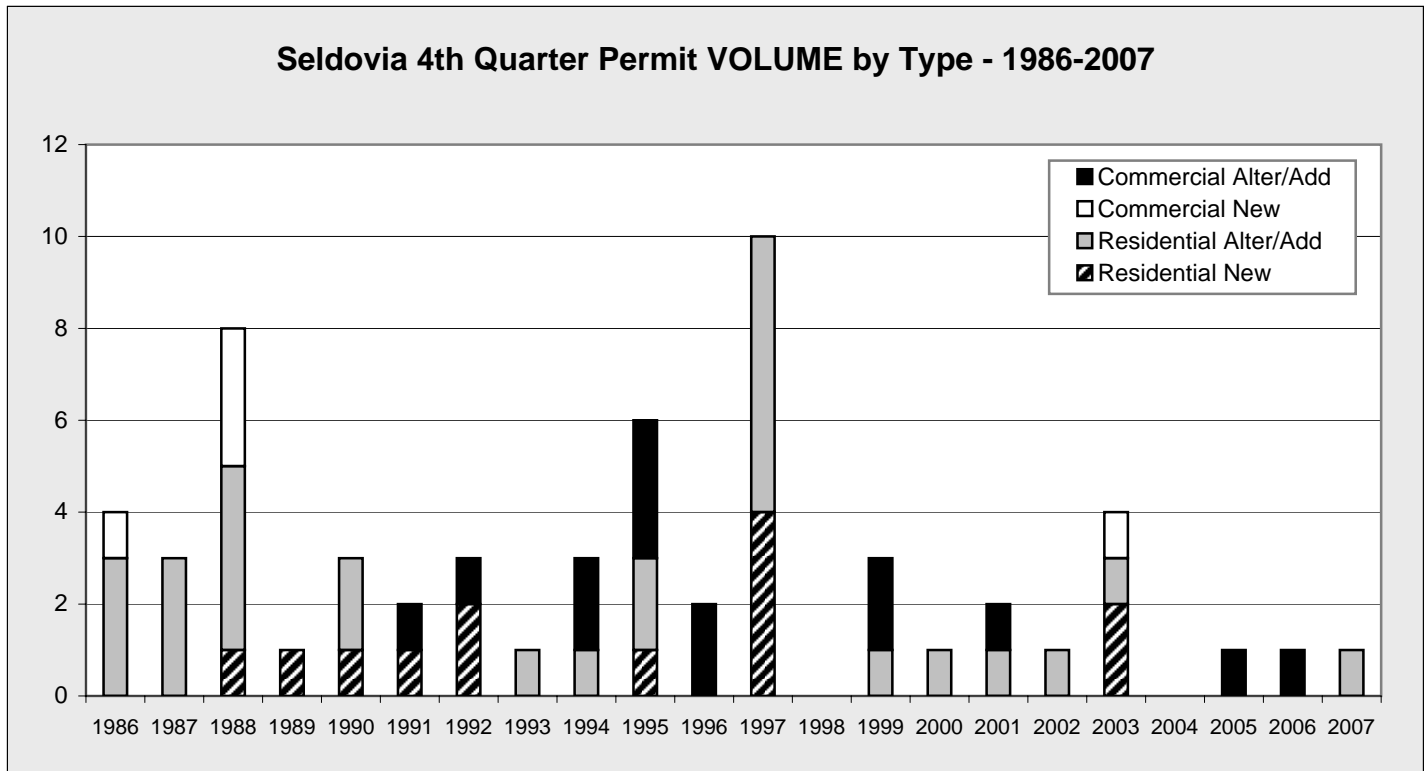

Chart 4.26

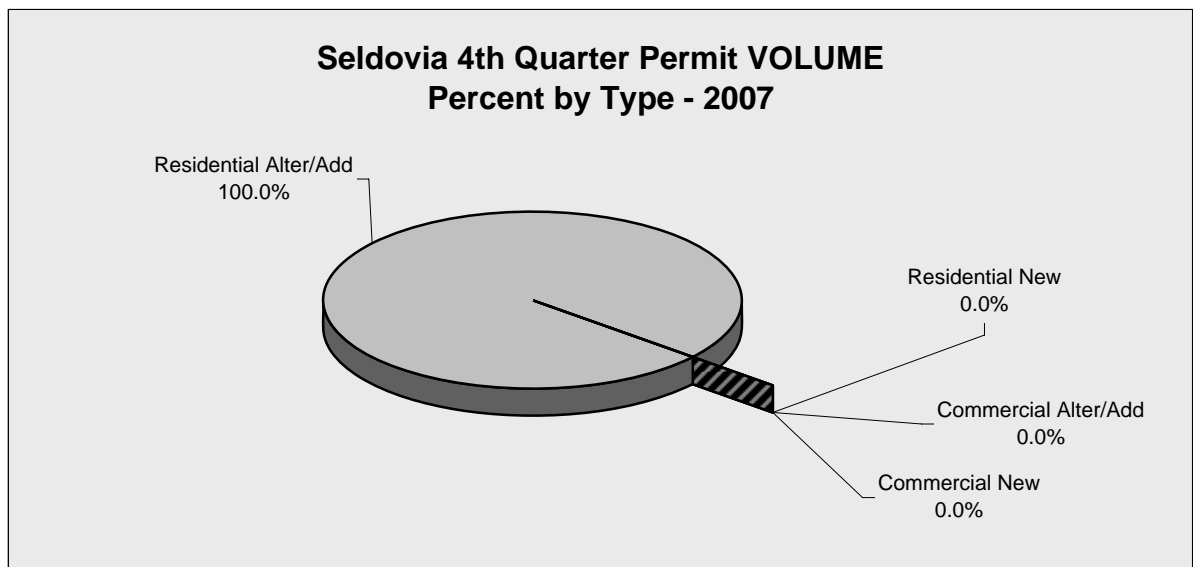

Chart 4.27

Seldovia Construction Permits

Seldovia ANNUAL Permit VALUES by Type - 2001-2007 - in \$							
	2001	2002	2003	2004	2005	2006	2007
Residential New	35,000	308,000	176,000	170,000	300,000	85,000	252,000
Residential Alter/Add	10,525	48,500	34,000	6,200	49,000	32,000	61,800
Commercial New	0	0	1,692,500	0	8,000	0	2,000
Commercial Alter/Add	20,000	0	0	0	155,000	18,000	28,000
Total	65,525	356,500	1,902,500	176,200	512,000	135,000	343,800
Annual Change		444.1%	433.7%	-90.7%	190.6%	-73.6%	154.7%

Table 4.24

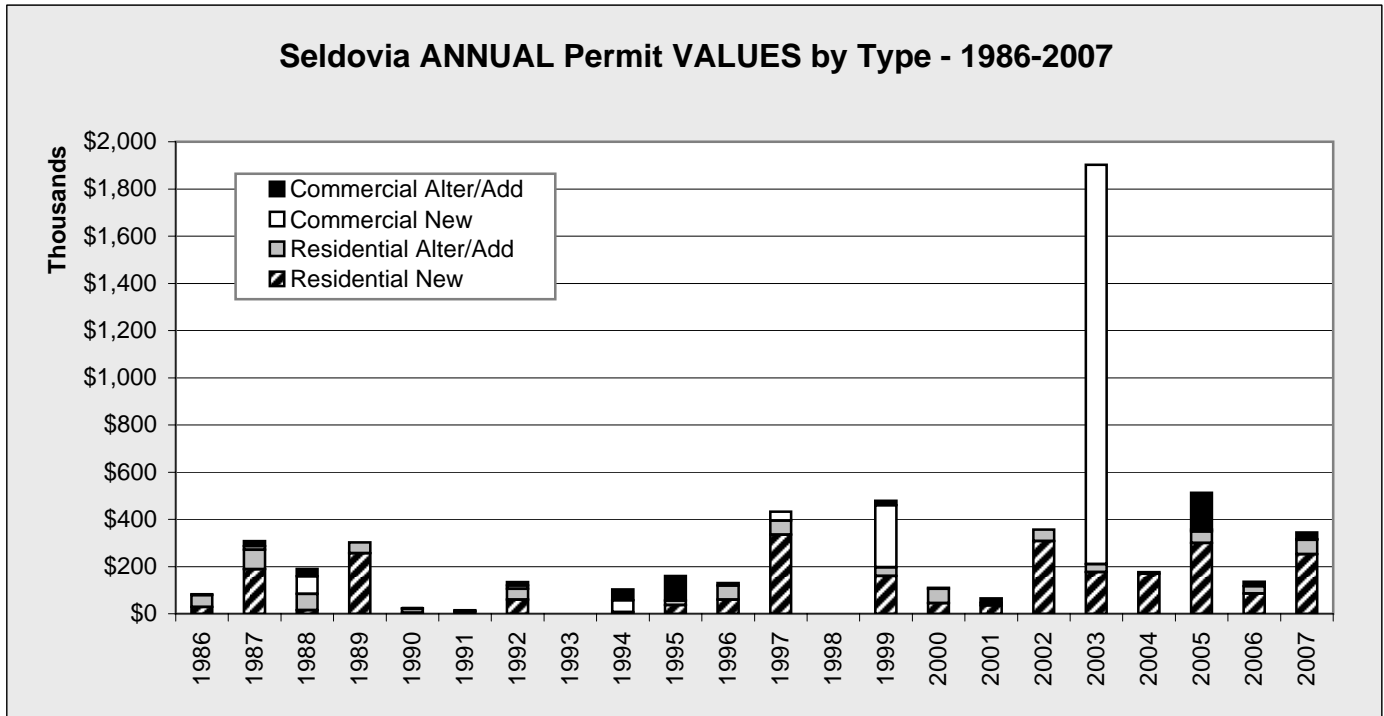

Chart 4.28

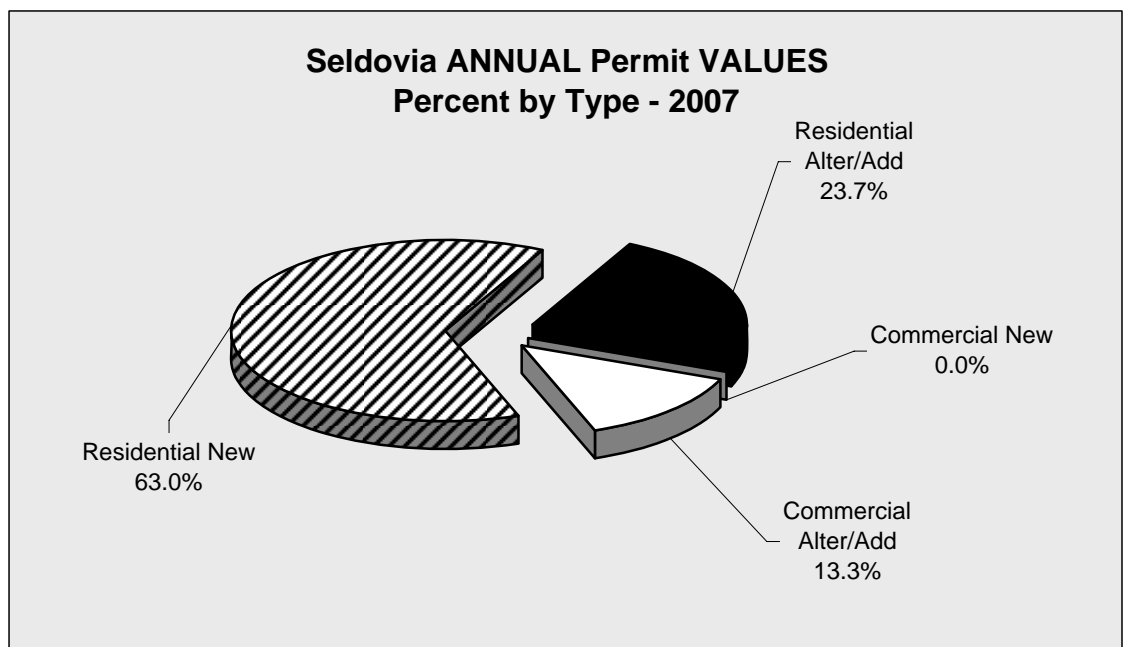

Chart 4.29

Seldovia Construction Permits

Seldovia ANNUAL Permit VOLUME by Type - 2001-2007

	2001	2002	2003	2004	2005	2006	2007	Annual Change
Residential New	2	2	3	2	2	3	4	1
Residential Alter/Add	5	6	4	2	3	3	10	7
Commercial New	0	0	4	0	1	0	1	1
Commercial Alter/Add	2	0	1	0	4	2	3	1
Total	9	8	12	4	10	8	18	10
Annual Change		-11.1%	50.0%	-66.7%	150.0%	-20.0%	125.0%	

Table 4.25

Seldovia ANNUAL Permit VOLUME by Type - 1986-2007

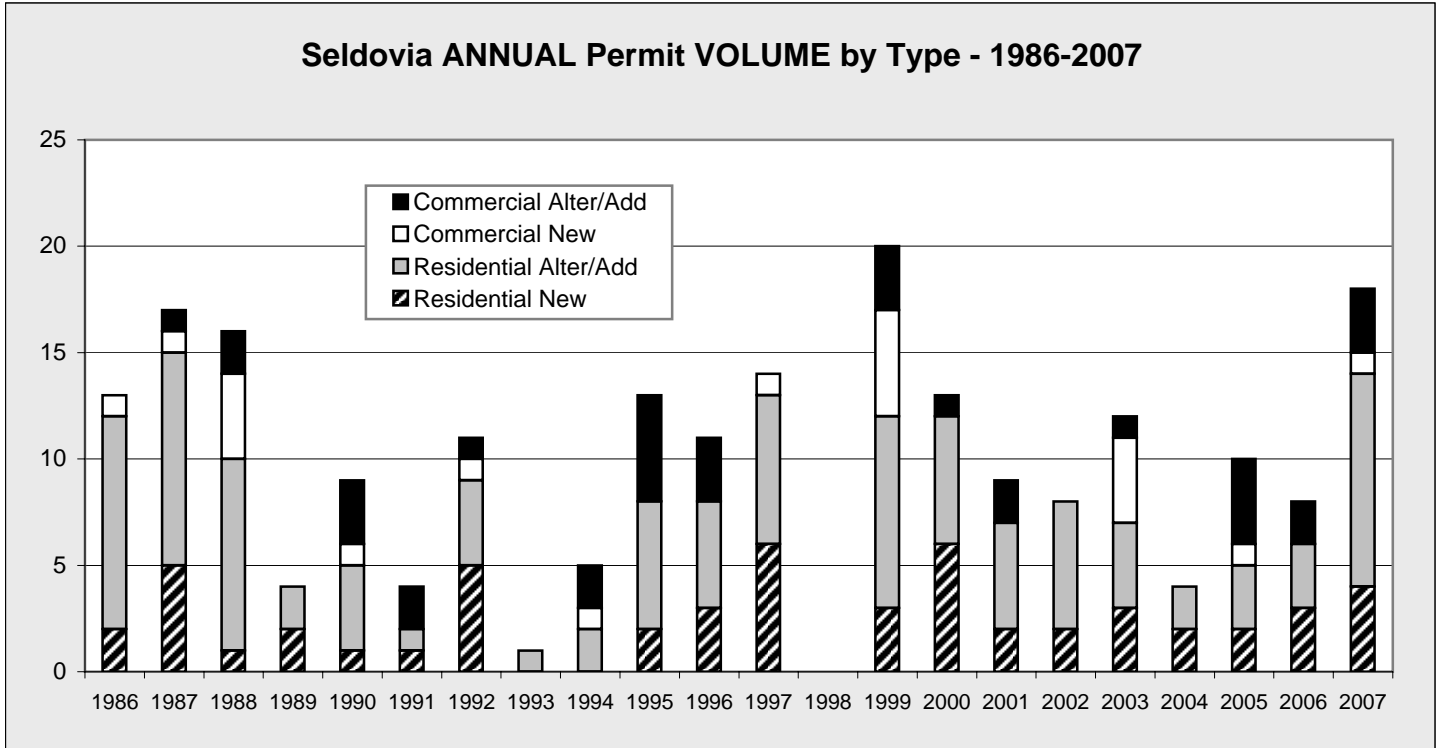

Chart 4.30

Seldovia ANNUAL Permit VOLUME Percent by Type - 2007

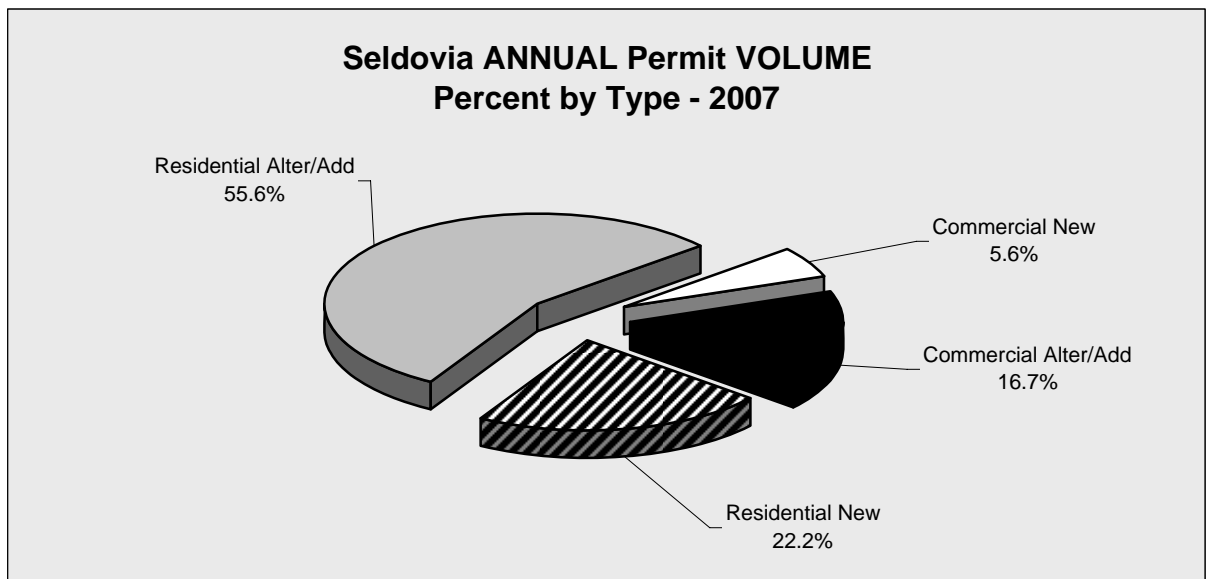

Chart 4.31

Seldovia Construction Permits

Seldovia Annual Permit VALUE by Type by Quarter - 2000-2007 - in \$					
	1st Quarter	2nd Quarter	3rd Quarter	4th Quarter	Total
2000					
Residential - New	18,000	8,000	19,000	0	45,000
Residential - Add/Alter	6,000	14,300	35,400	5,000	60,700
Commercial - New	0	0	0	0	0
Commercial - Add/Alter	0	0	3,500	0	3,500
TOTAL	24,000	22,300	57,900	5,000	109,200
2001					
Residential - New	0	25,000	10,000	0	35,000
Residential - Add/Alter	0	0	5,525	5,000	10,525
Commercial - New	0	0	0	0	0
Commercial - Add/Alter	10,000	0	0	10,000	20,000
TOTAL	10,000	25,000	15,525	15,000	65,525
2002					
Residential - New	0	0	308,000	0	308,000
Residential - Add/Alter	10,000	8,000	10,500	20,000	48,500
Commercial - New	0	0	0	0	0
Commercial - Add/Alter	0	0	0	0	0
TOTAL	10,000	8,000	318,500	20,000	356,500
2003					
Residential - New	0	0	150,000	26,000	176,000
Residential - Add/Alter	31,000	0	0	3,000	34,000
Commercial - New	0	0	1,685,000	7,500	1,692,500
Commercial - Add/Alter	0	0	0	0	0
TOTAL	31,000	0	1,835,000	36,500	1,902,500
2004					
Residential - New	20,000	150,000	0	0	170,000
Residential - Add/Alter	0	6,200	0	0	6,200
Commercial - New	0	0	0	0	0
Commercial - Add/Alter	0	0	0	0	0
TOTAL	20,000	156,200	0	0	176,200
2005					
Residential - New	0	300,000	0	0	300,000
Residential - Add/Alter	15,000	4,000	30,000	0	49,000
Commercial - New	0	8,000	0	0	8,000
Commercial - Add/Alter	0	154,000	500	500	155,000
TOTAL	15,000	466,000	30,500	500	512,000
2006					
Residential - New	30,000	55,000	0	0	85,000
Residential - Add/Alter	0	32,000	0	0	32,000
Commercial - New	0	0	0	0	0
Commercial - Add/Alter	0	0	0	18,000	18,000
TOTAL	30,000	87,000	0	18,000	135,000
2007					
Residential - New	0	227,000	25,000	0	252,000
Residential - Add/Alter	15,000	30,000	15,800	1,000	61,800
Commercial - New	0	2,000	0	0	2,000
Commercial - Add/Alter	0	8,000	20,000	0	28,000
TOTAL	15,000	267,000	60,800	1,000	343,800

Table 4.26

Seldovia Construction Permits

Seldovia Annual Permit VOLUME by Type by Quarter - 2000-2007					
	1st Quarter	2nd Quarter	3rd Quarter	4th Quarter	Total
2000					
Residential - New	2	2	2	0	6
Residential - Add/Alter	1	1	3	1	6
Commercial - New	0	0	0	0	0
Commercial - Add/Alter	0	0	1	0	1
TOTAL	3	3	6	1	13
2001					
Residential - New	0	1	1	0	2
Residential - Add/Alter	0	0	4	1	5
Commercial - New	0	0	0	0	0
Commercial - Add/Alter	1	0	0	1	2
TOTAL	1	1	5	2	9
2002					
Residential - New	0	0	2	0	2
Residential - Add/Alter	1	2	2	1	6
Commercial - New	0	0	0	0	0
Commercial - Add/Alter	0	0	0	0	0
TOTAL	1	2	4	1	8
2003					
Residential - New	0	0	1	2	3
Residential - Add/Alter	3	0	0	1	4
Commercial - New	0	0	3	1	4
Commercial - Add/Alter	0	0	1	0	1
TOTAL	3	0	5	4	12
2004					
Residential - New	1	1	0	0	2
Residential - Add/Alter	0	2	0	0	2
Commercial - New	0	0	0	0	0
Commercial - Add/Alter	0	0	0	0	0
TOTAL	1	3	0	0	4
2005					
Residential - New	0	2	0	0	2
Residential - Add/Alter	1	1	1	0	3
Commercial - New	0	1	0	0	1
Commercial - Add/Alter	0	2	1	1	4
TOTAL	1	6	2	1	10
2006					
Residential - New	1	2	0	0	3
Residential - Add/Alter	0	3	0	0	3
Commercial - New	0	0	0	0	0
Commercial - Add/Alter	0	1	0	1	2
TOTAL	1	6	0	1	8
2007					
Residential - New	0	3	1	0	4
Residential - Add/Alter	1	4	4	1	10
Commercial - New	0	1	0	0	1
Commercial - Add/Alter	0	1	2	0	3
TOTAL	1	9	7	1	18

Table 4.27

Seward Sales

Seward Annual Gross Sales by Quarter - in \$						
	1st Quarter	2nd Quarter	3rd Quarter	4th Quarter	Total	Annual Change
1991	16,079,202	27,435,377	28,976,635	18,079,963	90,571,177	
1992	15,682,430	23,843,299	28,946,534	19,515,019	87,987,282	-2.9%
1993	14,382,571	26,658,402	34,896,156	16,618,793	92,555,922	5.2%
1994	16,634,219	28,820,027	35,815,554	18,605,214	99,875,014	7.9%
1995	17,305,724	31,743,226	49,705,098	28,713,985	127,468,033	27.6%
1996	22,782,553	35,228,909	48,116,743	27,720,437	133,848,642	5.0%
1997	23,787,658	38,959,842	54,552,242	28,247,933	145,547,675	8.7%
1998	22,948,971	35,050,219	50,480,063	24,026,995	132,506,248	-9.0%
1999	23,356,887	36,041,325	50,509,645	20,247,664	130,155,521	-1.8%
2000	19,087,797	38,017,519	57,262,889	27,790,366	142,158,571	9.2%
2001	20,537,710	44,452,278	62,874,759	20,503,354	148,368,101	4.4%
2002	22,954,013	40,385,376	56,721,649	22,308,588	142,369,626	-4.0%
2003	20,935,184	46,984,153	61,708,185	27,334,414	156,961,936	10.2%
2004	21,175,289	42,749,272	63,911,158	38,360,976	166,196,695	5.9%
2005	26,468,833	58,467,271	70,190,050	34,221,900	189,348,054	13.9%
2006	21,700,942	51,137,438	75,794,619	49,932,284	198,565,283	4.9%
2007	25,607,934	56,765,182	78,600,775	30,399,133	191,373,024	-3.6%
Change	18.0%	11.0%	3.7%	-39.1%	-3.6%	

Table 5.1

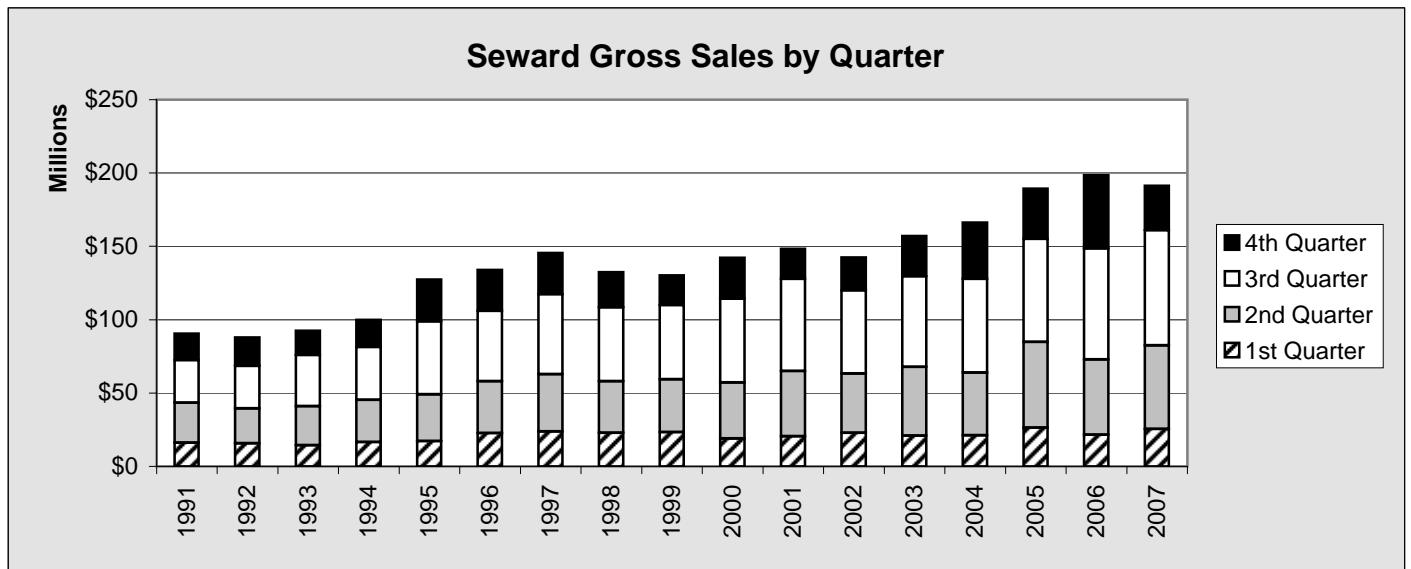

Chart 5.1

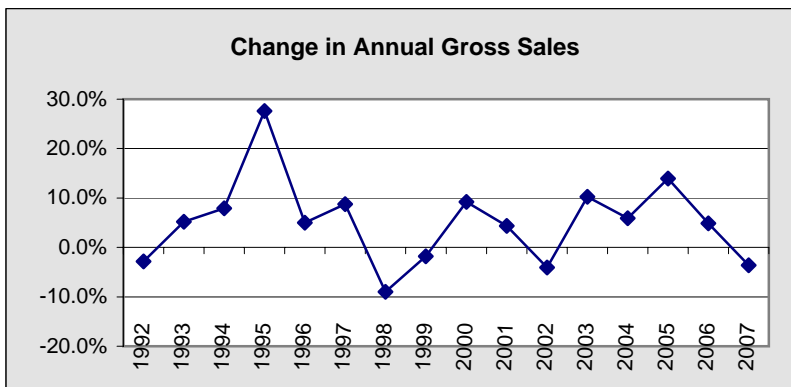

Chart 5.2

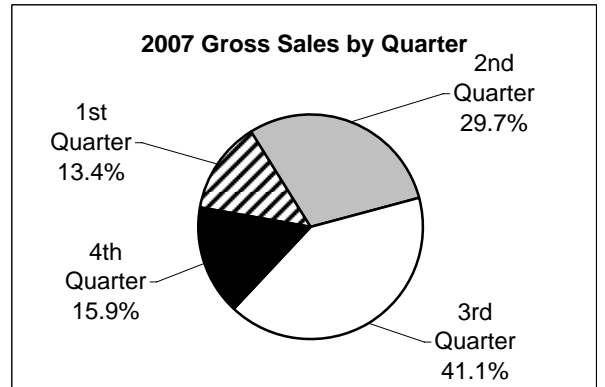

Chart 5.3

Seward Sales

Seward Annual Taxable Sales by Quarter - in \$						
	1st Quarter	2nd Quarter	3rd Quarter	4th Quarter	Total	Annual Change
1991	7,046,958	12,821,452	15,454,691	7,224,130	42,547,231	
1992	7,469,903	12,862,815	17,051,685	7,835,203	45,219,606	6.3%
1993	7,026,014	14,130,501	19,380,374	8,095,448	48,632,337	7.5%
1994	7,525,434	15,434,817	21,557,820	8,741,106	53,259,177	9.5%
1995	7,674,012	16,721,903	22,899,202	8,461,870	55,756,987	4.7%
1996	8,027,358	16,410,250	24,077,648	8,681,685	57,196,941	2.6%
1997	8,770,990	16,994,442	26,208,216	10,542,376	62,516,024	9.3%
1998	8,541,911	19,372,356	29,591,398	9,772,599	67,278,264	7.6%
1999	9,218,678	19,907,186	31,789,068	10,557,267	71,472,199	6.2%
2000	9,374,360	21,161,398	32,904,973	10,544,695	73,985,426	3.5%
2001	9,073,993	21,553,264	33,591,833	10,007,501	74,226,591	0.3%
2002	9,051,044	22,176,474	34,338,060	10,025,144	75,590,722	1.8%
2003	9,284,504	22,072,081	34,702,846	10,289,302	76,348,733	1.0%
2004	9,496,108	22,991,903	37,073,868	10,386,426	79,948,305	4.7%
2005	10,090,985	25,367,609	41,123,476	11,427,213	88,009,283	10.1%
2006	10,170,398	26,596,215	42,413,740	11,846,257	91,026,610	3.4%
2007	10,869,698	30,203,686	49,041,398	10,374,314	100,489,096	10.4%
Change	6.9%	13.6%	15.6%	-12.43%	10.4%	

Table 5.2

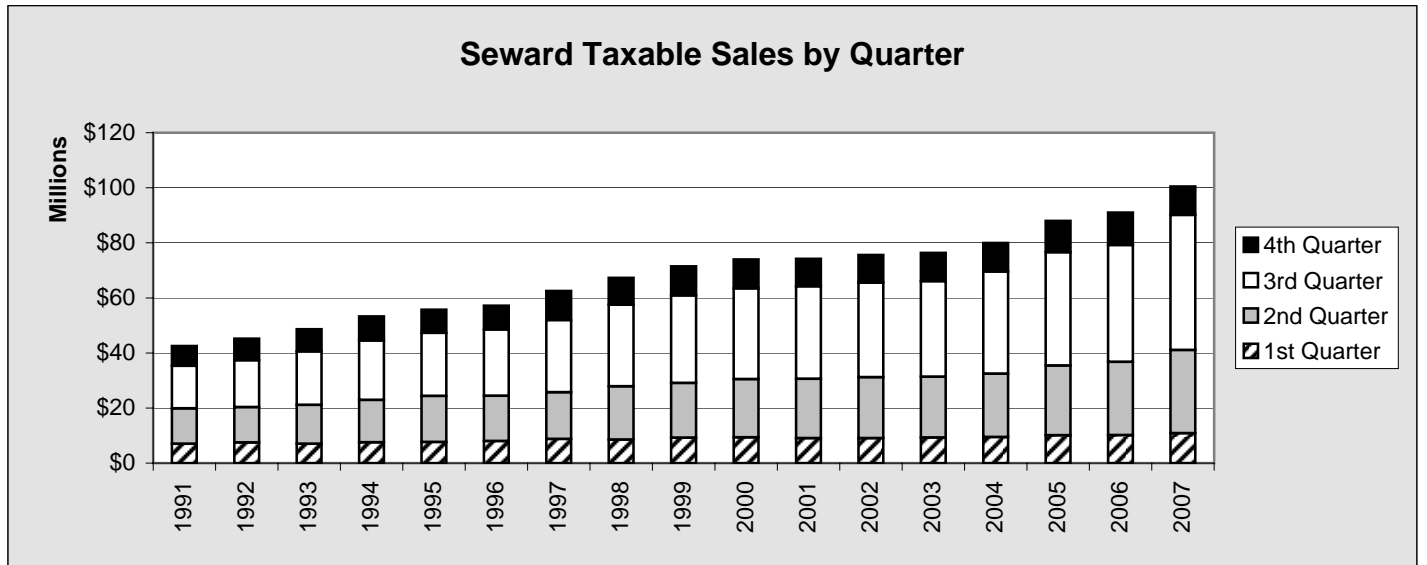

Chart 5.4

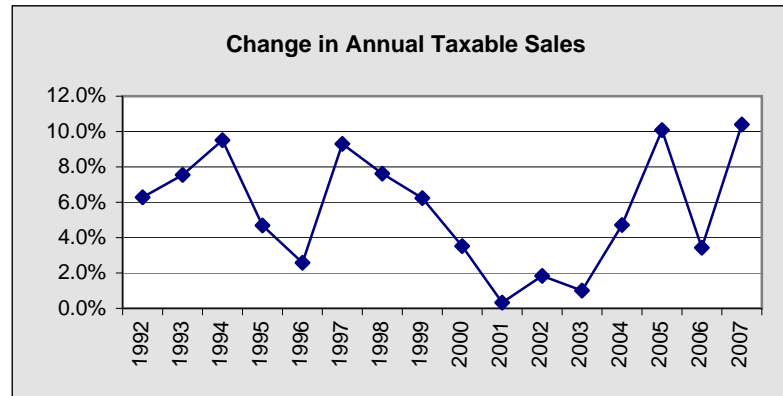

Chart 5.5

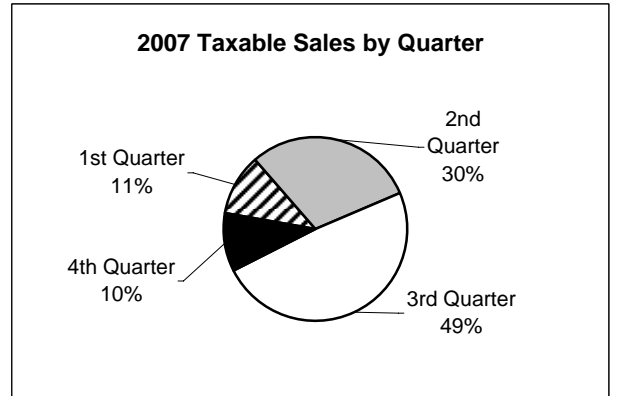

Chart 5.6

Seward Sales

Seward Annual Nontaxable Sales by Quarter - in \$

	1st Quarter	2nd Quarter	3rd Quarter	4th Quarter	Total	Annual Change
1991	9,032,244	14,613,925	13,521,944	10,855,833	48,023,946	
1992	8,212,527	10,980,484	11,894,849	11,679,816	42,767,676	-10.9%
1993	7,356,557	12,527,901	15,515,782	8,523,345	43,923,585	2.7%
1994	9,108,785	13,385,210	14,257,734	9,864,108	46,615,837	6.1%
1995	9,631,712	15,021,323	26,805,896	20,252,115	71,711,046	53.8%
1996	14,755,195	18,818,659	24,039,095	19,038,752	76,651,701	6.9%
1997	15,016,668	21,965,400	28,344,026	17,705,557	83,031,651	8.3%
1998	14,407,060	15,677,863	20,888,665	14,254,396	65,227,984	-21.4%
1999	14,138,209	16,134,139	18,720,577	9,690,397	58,683,322	-10.0%
2000	9,713,437	16,856,121	24,357,916	17,245,671	68,173,145	16.2%
2001	11,463,717	22,899,014	29,282,926	10,495,853	74,141,510	8.8%
2002	13,902,969	18,208,902	22,383,589	12,283,444	66,778,904	-9.9%
2003	11,650,680	24,912,072	27,005,339	17,045,112	80,613,203	20.7%
2004	11,679,181	19,757,369	26,837,290	27,974,550	86,248,390	7.0%
2005	16,377,848	33,099,662	29,066,574	22,794,687	101,338,771	17.5%
2006	11,530,544	24,541,223	33,380,879	38,086,027	107,538,673	6.1%
2007	14,738,236	26,561,496	29,559,377	20,024,819	90,883,928	-15.5%
Change	27.8%	8.2%	-11.4%	-47.4%	-15.5%	

Table 5.3

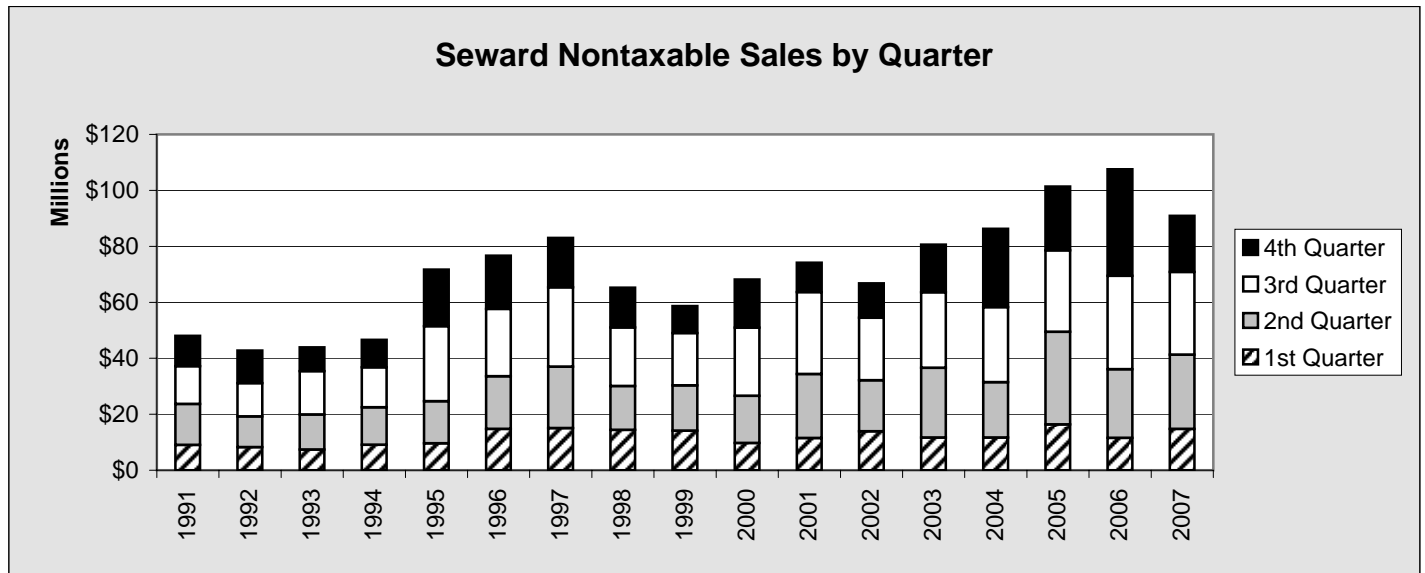

Chart 5.7

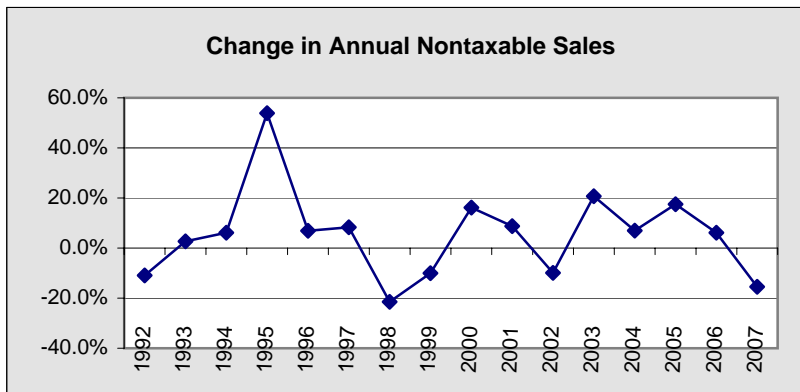

Chart 5.8

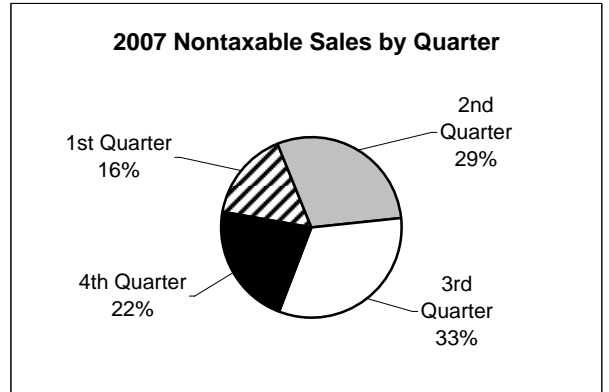

Chart 5.9

Seward Sales

Seward 4th Quarter GROSS Sales by Line of Business - 2002-2007 - in \$								
LOB	2002	2003	2004	2005	2006	2007	Annual Percent Change	Annual Amount Change
RSRC	347,956	100,530	147,936	43,578	406,501	238,380	-41.4%	-168,121
SALES	6,033,305	6,126,606	6,319,248	6,967,267	7,570,055	7,810,492	3.2%	240,437
CONST	2,754,843	5,499,778	16,339,146	8,013,544	19,492,925	5,928,985	-69.6%	-13,563,940
PROP	1,413,504	2,586,389	1,834,786	2,845,096	3,133,114	1,686,799	-46.2%	-1,446,315
TOUR	1,557,440	1,525,266	1,563,370	1,464,483	1,525,259	1,411,249	-7.5%	-114,010
SERV	1,882,387	1,636,525	1,774,416	1,816,387	1,976,529	1,997,823	1.1%	21,294
PROF	877,562	603,189	2,059,288	1,913,831	1,828,040	1,510,573	-17.4%	-317,467
UTIL	561,980	675,956	702,113	821,296	1,055,935	1,052,599	-0.3%	-3,336
MANU	2,728,387	3,223,518	1,375,246	2,625,578	1,920,203	2,692,162	40.2%	771,959
TRAN	793,192	678,468	1,286,227	1,460,100	1,154,043	1,517,486	31.5%	363,443
WHLS	2,037,981	3,292,713	3,471,601	4,601,966	8,103,529	4,480,585	-44.7%	-3,622,944
GOV	1,320,051	1,385,476	1,487,599	1,648,774	1,766,151	72,000	-95.9%	-1,694,151
TOTAL	22,308,588	27,334,414	38,360,976	34,221,900	49,932,284	30,399,133	-39.1%	-19,533,151

Table 5.4

For complete listing of Lines of Business, see page 13

Seward 4th Quarter GROSS Sales History	
2002	22,308,588
2003	27,334,414
2004	38,360,976
2005	34,221,900
2006	49,932,284
2007	30,399,133

Table 5.5

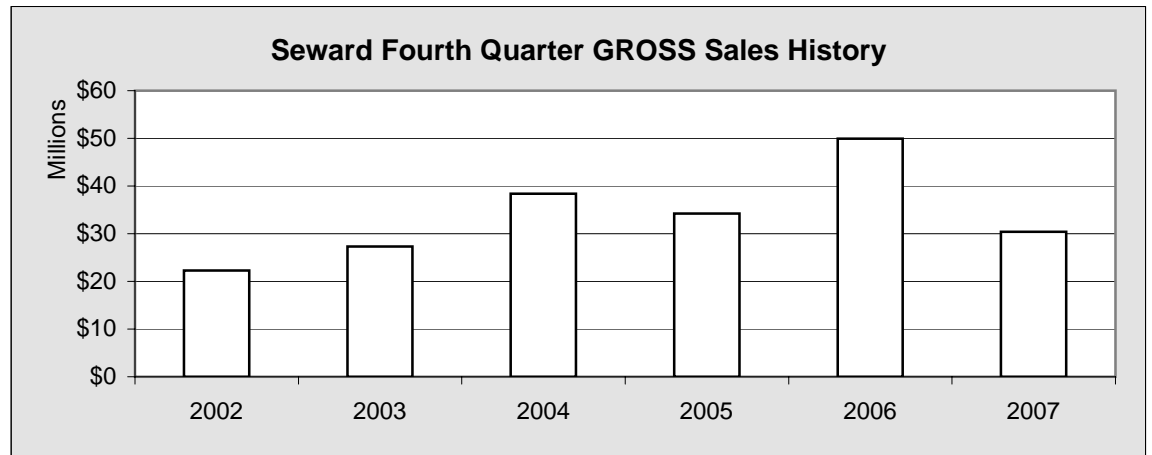

Chart 5.10

Seward Five Year Change 4th Quarter GROSS Sales		
LOB	2002	2007
RSRC	347,956	238,380
SALES	6,033,305	7,810,492
CONST	2,754,843	5,928,985
PROP	1,413,504	1,686,799
TOUR	1,557,440	1,411,249
SERV	1,882,387	1,997,823
PROF	877,562	1,510,573
UTIL	561,980	1,052,599
MANU	2,728,387	2,692,162
TRAN	793,192	1,517,486
WHLS	2,037,981	4,480,585
GOV	1,320,051	72,000

Table 5.6

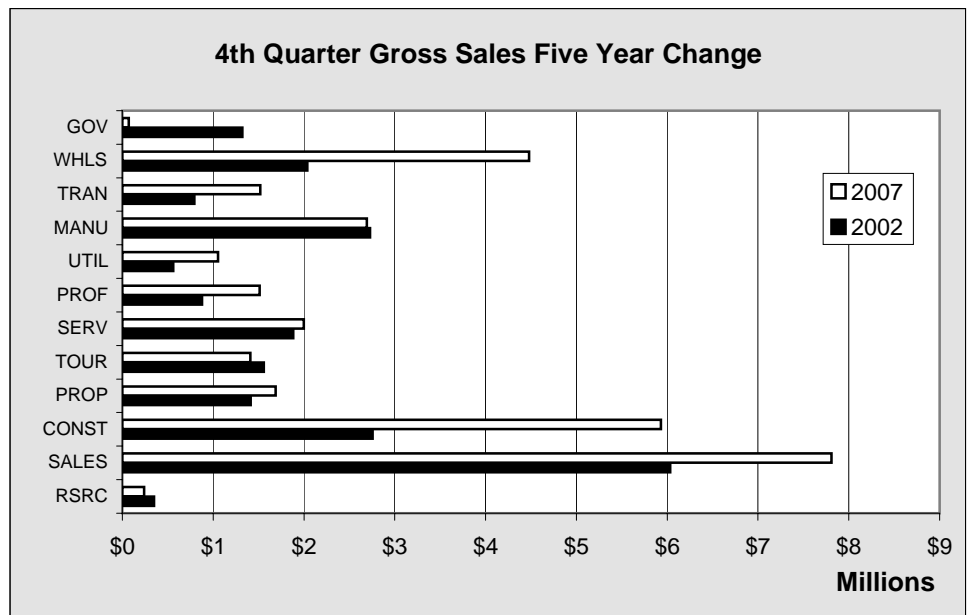

Chart 5.11

Seward Sales

Seward 4th Quarter TAXABLE Sales by Line of Business - 2002-2007 - in \$								
LOB	2002	2003	2004	2005	2006	2007	Annual Percent Change	Annual Amount Change
RSRC	11,071	15,995	10,694	15,264	12,359	16,799	35.9%	4,440
SALES	4,731,426	4,966,976	4,951,964	5,676,326	5,989,723	6,320,755	5.5%	331,032
CONST	128,936	168,604	168,487	153,919	177,126	136,027	-23.2%	-41,099
PROP	451,340	412,450	415,842	394,058	426,431	397,277	-6.8%	-29,154
TOUR	1,454,416	1,373,686	1,376,780	1,256,703	1,353,519	1,296,771	-4.2%	-56,748
SERV	884,911	963,182	937,258	1,043,249	1,128,773	1,101,162	-2.4%	-27,611
PROF	169,698	105,679	114,562	101,390	113,177	120,947	6.9%	7,770
UTIL	500	801	416	0	2,744	18	-99.3%	-2,726
MANU	100,947	117,311	112,491	66,981	82,548	98,723	19.6%	16,175
TRAN	282,295	167,718	154,067	361,410	55,116	41,584	-24.6%	-13,532
WHLS	489,553	611,424	720,266	773,219	810,870	844,251	4.1%	33,381
GOV	1,320,051	1,385,476	1,423,599	1,584,694	1,693,871	0	-100.0%	-1,693,871
TOTAL	10,025,144	10,289,302	10,386,426	11,427,213	11,846,257	10,374,314	-12.4%	-1,471,943

Table 5.7

For complete listing of Lines of Business, see page 13

Seward 4th Quarter TAXABLE Sales History	
2002	10,025,144
2003	10,289,302
2004	10,386,426
2005	11,427,213
2006	11,846,257
2007	10,374,314

Table 5.8

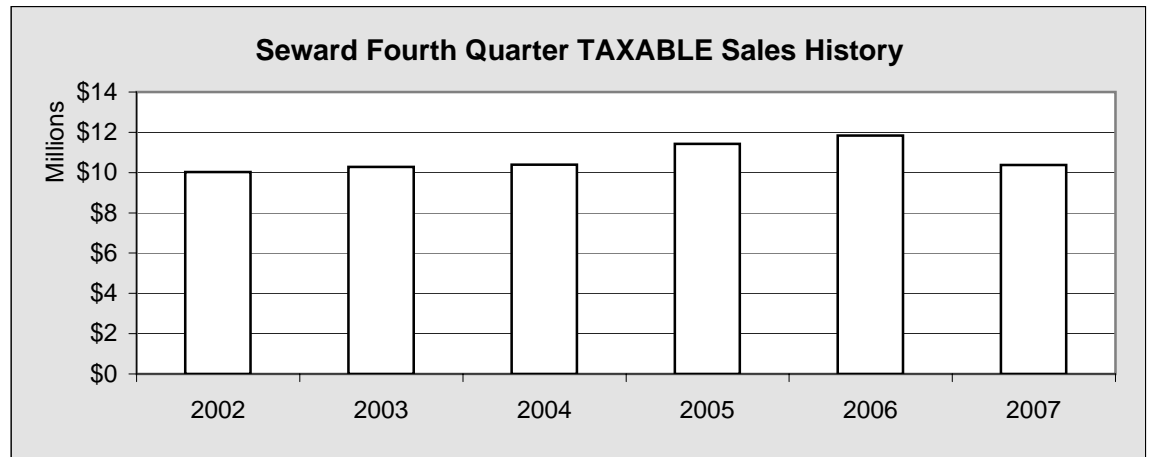

Chart 5.12

Seward Five Year Change 4th Quarter TAXABLE Sales		
LOB	2002	2007
RSRC	11,071	16,799
SALES	4,731,426	6,320,755
CONST	128,936	136,027
PROP	451,340	397,277
TOUR	1,454,416	1,296,771
SERV	884,911	1,101,162
PROF	169,698	120,947
UTIL	500	18
MANU	100,947	98,723
TRAN	282,295	41,584
WHLS	489,553	844,251
GOV	1,320,051	0

Table 5.9

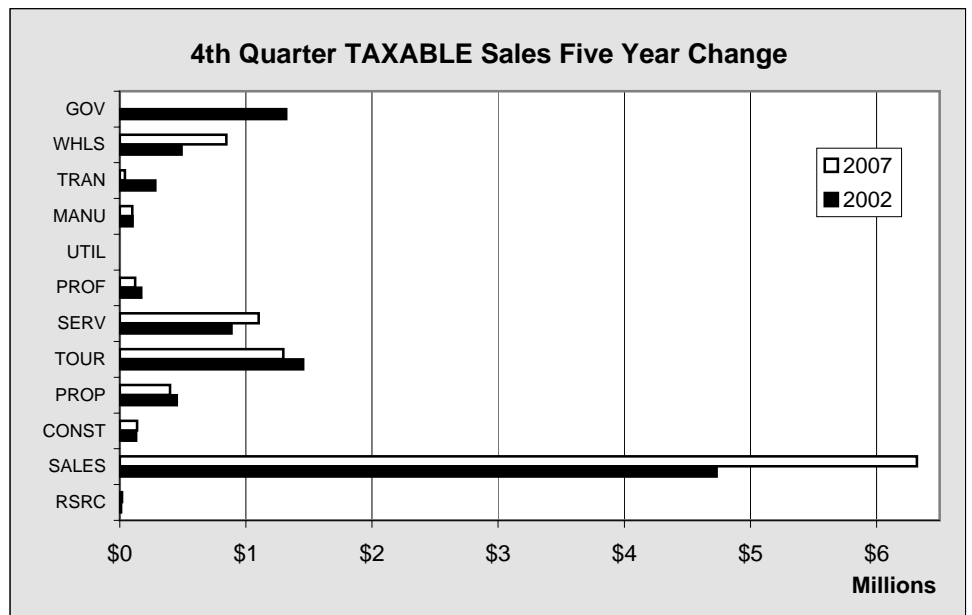

Chart 5.13

Seward Sales

Seward Annual GROSS Sales by Line of Business - 2002-2007 - in \$

LOB	2002	2003	2004	2005	2006	2007	Annual Percent Change	Annual Amount Change
RSRC	802,285	471,217	493,990	456,941	681,565	1,541,285	126.1%	859,720
SALES	34,598,474	34,477,471	36,812,924	42,226,020	44,400,928	49,271,234	11.0%	4,870,306
CONST	9,912,563	26,480,094	29,901,929	39,308,940	38,327,087	19,356,529	-49.5%	-18,970,558
PROP	9,523,579	10,726,937	8,391,137	8,812,070	9,308,644	7,522,792	-19.2%	-1,785,852
TOUR	17,512,593	17,220,986	18,235,704	19,399,106	32,576,703	35,791,156	9.9%	3,214,453
SERV	11,021,132	9,153,785	9,168,823	8,343,998	8,710,179	11,730,639	34.7%	3,020,460
PROF	2,671,268	3,099,221	3,533,910	3,890,494	4,824,816	3,765,025	-22.0%	-1,059,791
UTIL	2,715,383	2,572,129	2,072,046	3,313,549	4,001,907	4,410,387	10.2%	408,480
MANU	12,415,772	13,428,447	10,469,080	13,038,483	10,410,686	16,893,525	62.3%	6,482,839
TRAN	22,689,005	20,573,537	22,914,268	24,211,631	11,505,806	12,480,835	8.5%	975,029
WHLS	13,293,957	13,481,110	18,671,998	20,448,645	27,657,623	23,931,163	-13.5%	-3,726,460
GOV	5,213,615	5,277,002	5,530,886	5,898,177	6,159,339	4,678,454	-24.0%	-1,480,885
TOTAL	142,369,626	156,961,936	166,196,695	189,348,054	198,565,283	191,373,024	-3.6%	-7,192,259

Table 5.10

For complete listing of Lines of Business, see page 13

Seward Annual GROSS Sales History	
2002	142,369,626
2003	156,961,936
2004	166,196,695
2005	189,348,054
2006	198,565,283
2007	191,373,024

Table 5.11

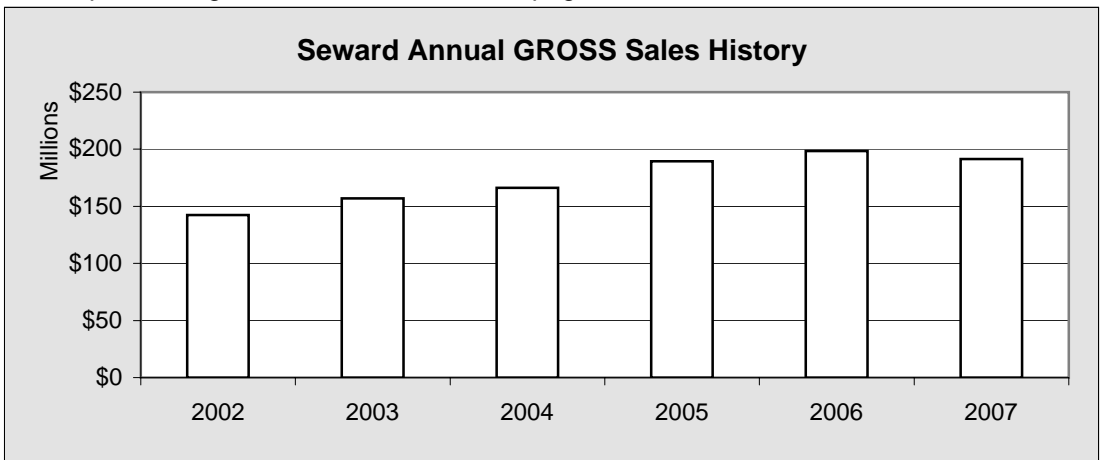

Chart 5.14

Five Year Change Annual GROSS Sales		
LOB	2002	2007
RSRC	802,285	1,541,285
SALES	34,598,474	49,271,234
CONST	9,912,563	19,356,529
PROP	9,523,579	7,522,792
TOUR	17,512,593	35,791,156
SERV	11,021,132	11,730,639
PROF	2,671,268	3,765,025
UTIL	2,715,383	4,410,387
MANU	12,415,772	16,893,525
TRAN	22,689,005	12,480,835
WHLS	13,293,957	23,931,163
GOV	5,213,615	4,678,454

Table 5.12

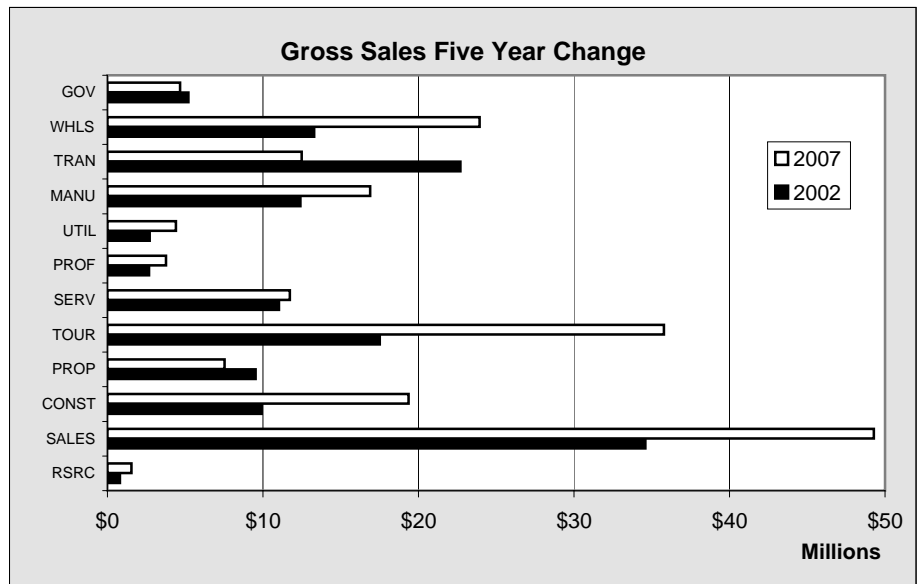

Chart 5.15

Seward Sales

Seward Annual TAXABLE Sales by Line of Business - 2002-2007 - in \$								
LOB	2002	2003	2004	2005	2006	2007	Annual Percent Change	Annual Amount Change
RSRC	39,760	47,923	38,750	36,855	54,985	69,011	25.5%	14,026
SALES	27,580,806	28,161,941	29,812,800	34,556,704	36,551,408	40,521,537	10.9%	3,970,129
CONST	541,249	647,537	667,509	665,120	669,932	578,291	-13.7%	-91,641
PROP	2,627,235	2,432,971	2,042,516	2,070,743	2,029,745	2,316,949	14.1%	287,204
TOUR	16,728,854	16,487,073	17,198,401	18,004,027	30,913,096	33,949,525	9.8%	3,036,429
SERV	4,069,752	4,232,905	4,585,533	4,537,169	4,775,336	5,890,900	23.4%	1,115,564
PROF	877,826	700,567	600,900	585,649	618,719	644,612	4.2%	25,893
UTIL	4,831	5,583	2,605	3,979	8,182	7,362	-10.0%	-820
MANU	949,966	954,975	1,029,895	938,171	958,824	998,446	4.1%	39,622
TRAN	13,188,398	13,270,848	13,822,059	15,319,131	3,105,951	5,443,485	75.3%	2,337,534
WHLS	3,768,430	4,134,748	4,680,451	5,457,638	5,253,373	5,462,524	4.0%	209,151
GOV	5,213,615	5,271,662	5,466,886	5,834,097	6,087,059	4,606,454	-24.3%	-1,480,605
TOTAL	75,590,722	76,348,733	79,948,305	88,009,283	91,026,610	100,489,096	10.4%	9,462,486

Table 5.13

For complete listing of Lines of Business, see page 13

Seward Annual TAXABLE Sales History	
2002	75,590,722
2003	76,348,733
2004	79,948,305
2005	88,009,283
2006	91,026,610
2007	100,489,096

Table 5.14

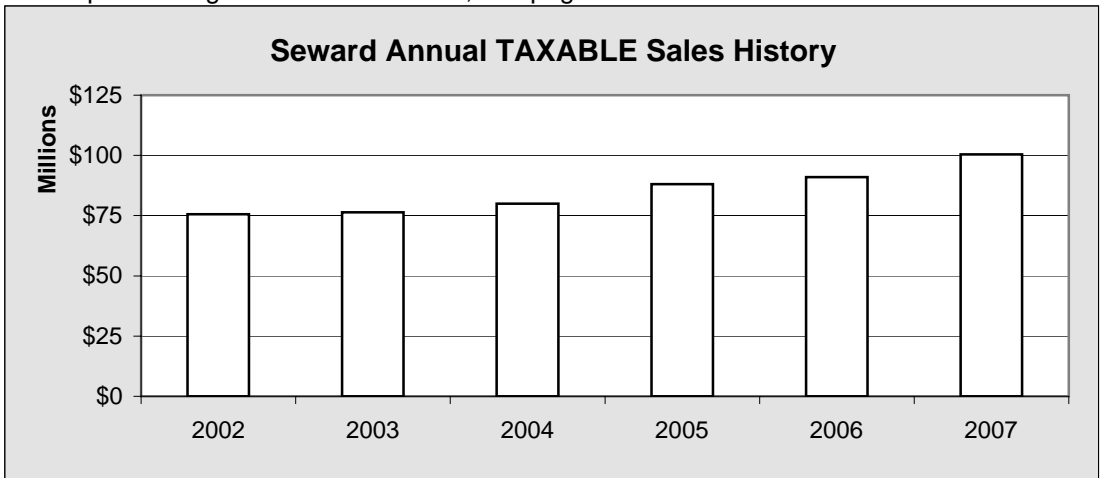

Chart 5.16

Five Year Change Annual TAXABLE Sales		
LOB	2002	2007
RSRC	39,760	69,011
SALES	27,580,806	40,521,537
CONST	541,249	578,291
PROP	2,627,235	2,316,949
TOUR	16,728,854	33,949,525
SERV	4,069,752	5,890,900
PROF	877,826	644,612
UTIL	4,831	7,362
MANU	949,966	998,446
TRAN	13,188,398	5,443,485
WHLS	3,768,430	5,462,524
GOV	5,213,615	4,606,454

Table 5.15

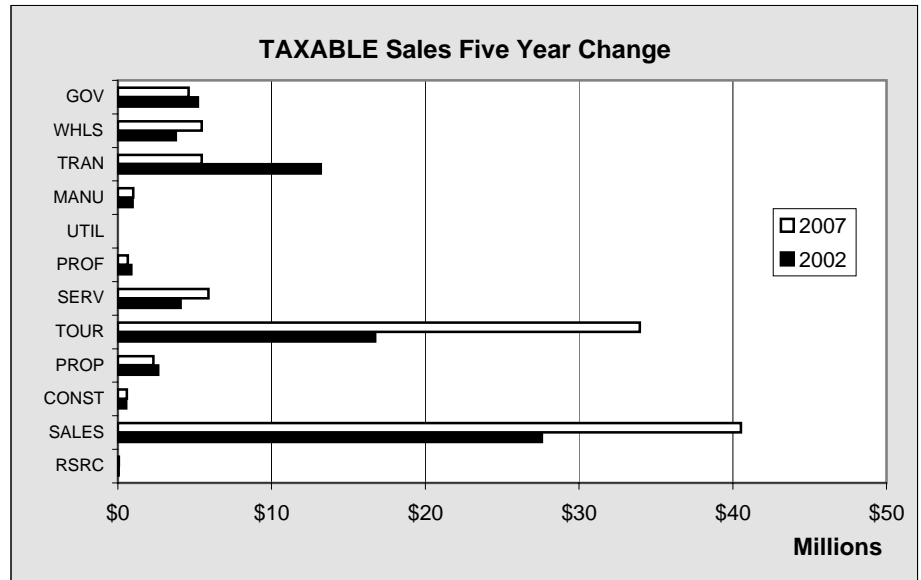

Chart 5.17

Seward Sales

Seward GROSS Sales by Line of Business by Quarter - 2007 - in \$					
LOB	1st Quarter	2nd Quarter	3rd Quarter	4th Quarter	Total
Resource Production	83,840	634,705	584,360	238,380	1,541,285
Sales	7,377,317	13,845,945	20,237,480	7,810,492	49,271,234
Construction	3,836,976	6,438,070	3,152,498	5,928,985	19,356,529
Property	1,288,277	1,810,993	2,736,723	1,686,799	7,522,792
Tourism	1,568,240	11,516,775	21,294,892	1,411,249	35,791,156
Services	2,079,439	3,696,132	3,957,245	1,997,823	11,730,639
Professional	574,529	752,534	927,389	1,510,573	3,765,025
Utility	1,163,003	1,124,674	1,070,111	1,052,599	4,410,387
Manufacturing	1,673,250	5,767,258	6,760,855	2,692,162	16,893,525
Transporation & Warehousing	280,387	3,325,974	7,356,988	1,517,486	12,480,835
Wholesale	4,279,210	6,298,639	8,872,729	4,480,585	23,931,163
Government	1,403,466	1,553,483	1,649,505	72,000	4,678,454
TOTAL	25,607,934	56,765,182	78,600,775	30,399,133	191,373,024

Table 5.16

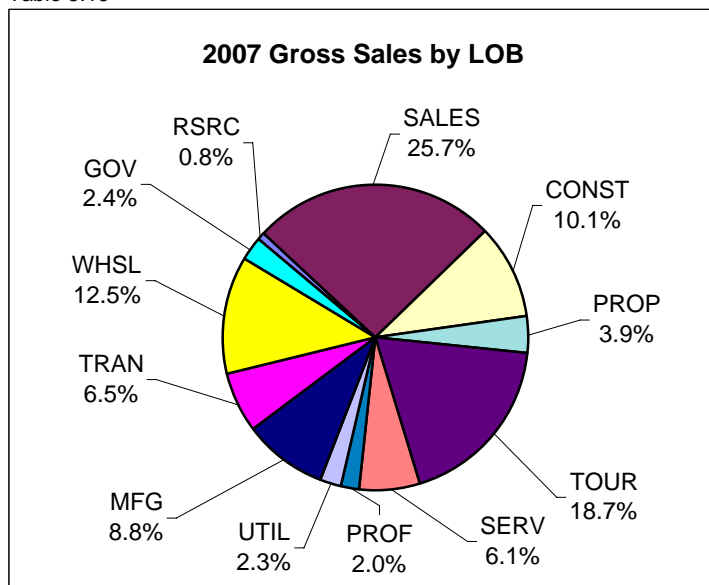

Chart 5.18

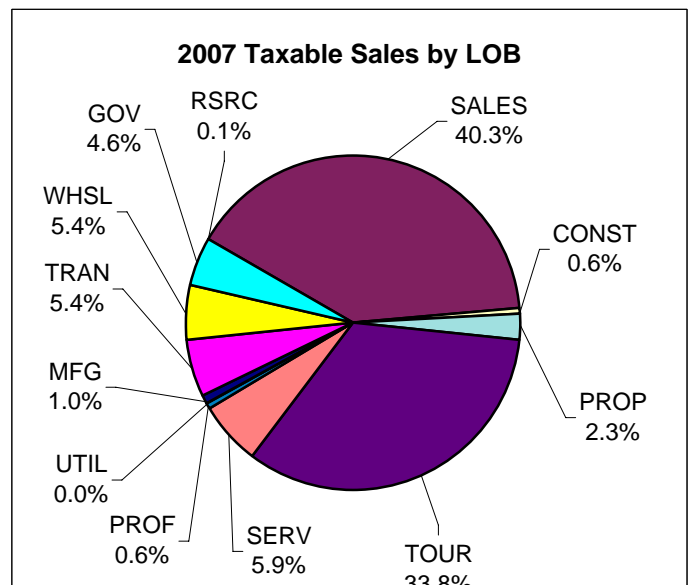

Chart 5.19

Seward TAXABLE Sales by Line of Business by Quarter - 2007 - in \$					
LOB	1st Quarter	2nd Quarter	3rd Quarter	4th Quarter	Total
Resource Production	10,462	20,107	21,643	16,799	69,011
Sales	5,459,433	11,620,567	17,120,782	6,320,755	40,521,537
Construction	128,867	170,996	142,401	136,027	578,291
Property	375,366	675,291	869,015	397,277	2,316,949
Tourism	1,365,035	10,824,532	20,463,187	1,296,771	33,949,525
Services	958,400	1,727,158	2,104,180	1,101,162	5,890,900
Professional	92,122	194,164	237,379	120,947	644,612
Utility	2,628	2,436	2,280	18	7,362
Manufacturing	79,293	335,739	484,691	98,723	998,446
Transporation & Warehousing	40,255	1,679,701	3,681,945	41,584	5,443,485
Wholesale	954,371	1,399,512	2,264,390	844,251	5,462,524
Government	1,403,466	1,553,483	1,649,505	0	4,606,454
TOTAL	10,869,698	30,203,686	49,041,398	10,374,314	100,489,096

Table 5.17

Seward Sales

Seward GROSS Sales by Line of Business by Quarter - 2006 - in \$					
LOB	1st Quarter	2nd Quarter	3rd Quarter	4th Quarter	Total
Resource Production	38,016	37,294	199,754	406,501	681,565
Sales	6,534,240	12,422,602	17,874,031	7,570,055	44,400,928
Construction	1,781,517	7,478,292	9,574,353	19,492,925	38,327,087
Property	1,749,751	2,180,277	2,245,502	3,133,114	9,308,644
Tourism	1,447,973	10,260,085	19,343,386	1,525,259	32,576,703
Services	1,619,731	2,366,302	2,747,617	1,976,529	8,710,179
Professional	924,106	917,531	1,155,139	1,828,040	4,824,816
Utility	751,746	964,113	1,230,113	1,055,935	4,001,907
Manufacturing	1,131,882	3,279,075	4,079,526	1,920,203	10,410,686
Transporation & Warehousing	429,327	2,897,681	7,024,755	1,154,043	11,505,806
Wholesale	3,994,826	6,886,194	8,673,074	8,103,529	27,657,623
Government	1,297,827	1,447,992	1,647,369	1,766,151	6,159,339
TOTAL	21,700,942	51,137,438	75,794,619	49,932,284	198,565,283

Table 5.18

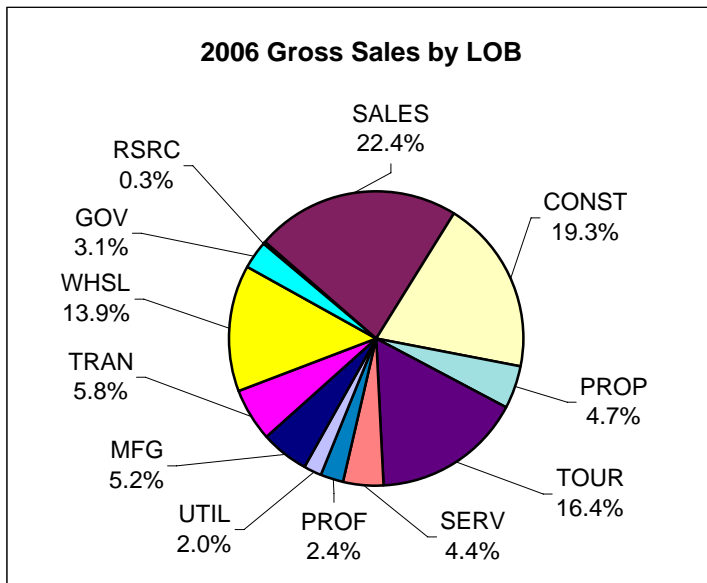

Chart 5.20

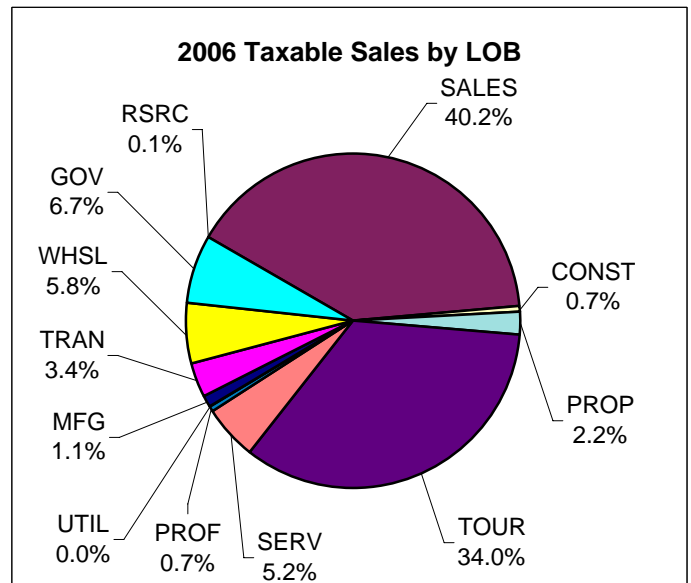

Chart 5.21

Seward TAXABLE Sales by Line of Business by Quarter - 2006 - in \$					
LOB	1st Quarter	2nd Quarter	3rd Quarter	4th Quarter	Total
Resource Production	12,393	9,759	20,474	12,359	54,985
Sales	5,117,560	10,499,840	14,944,285	5,989,723	36,551,408
Construction	138,509	195,664	158,633	177,126	669,932
Property	346,277	514,332	742,705	426,431	2,029,745
Tourism	1,309,050	9,758,859	18,491,668	1,353,519	30,913,096
Services	883,085	1,321,862	1,441,616	1,128,773	4,775,336
Professional	84,016	211,249	210,277	113,177	618,719
Utility	1,775	3,413	250	2,744	8,182
Manufacturing	79,798	320,784	475,694	82,548	958,824
Transporation & Warehousing	45,897	926,030	2,078,908	55,116	3,105,951
Wholesale	854,211	1,386,431	2,201,861	810,870	5,253,373
Government	1,297,827	1,447,992	1,647,369	1,693,871	6,087,059
TOTAL	10,170,398	26,596,215	42,413,740	11,846,257	91,026,610

Table 5.19

Seward Sales

Seward GROSS Sales by Line of Business by Quarter - 2005 - in \$					
LOB	1st Quarter	2nd Quarter	3rd Quarter	4th Quarter	Total
Resource Production	69,774	188,568	155,021	43,578	456,941
Sales	6,018,921	11,976,160	17,263,672	6,967,267	42,226,020
Construction	7,763,325	16,685,949	6,846,122	8,013,544	39,308,940
Property	1,285,380	2,249,589	2,432,005	2,845,096	8,812,070
Tourism	1,665,675	5,877,386	10,391,562	1,464,483	19,399,106
Services	1,624,343	2,354,164	2,549,104	1,816,387	8,343,998
Professional	581,272	616,040	779,351	1,913,831	3,890,494
Utility	763,559	792,413	936,281	821,296	3,313,549
Manufacturing	1,494,881	3,455,547	5,462,477	2,625,578	13,038,483
Transportation & Warehousing	1,244,815	6,919,543	14,587,173	1,460,100	24,211,631
Wholesale	2,713,342	5,960,258	7,173,079	4,601,966	20,448,645
Government	1,243,546	1,391,654	1,614,203	1,648,774	5,898,177
TOTAL	26,468,833	58,467,271	70,190,050	34,221,900	189,348,054

Table 5.20

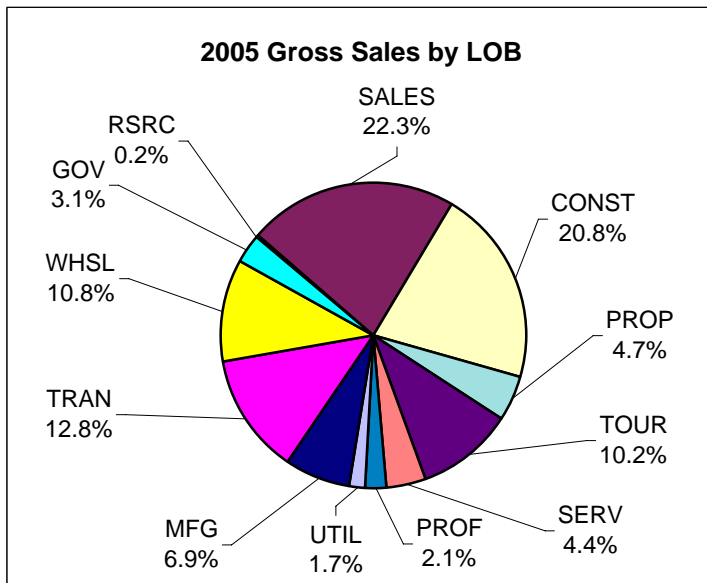

Chart 5.22

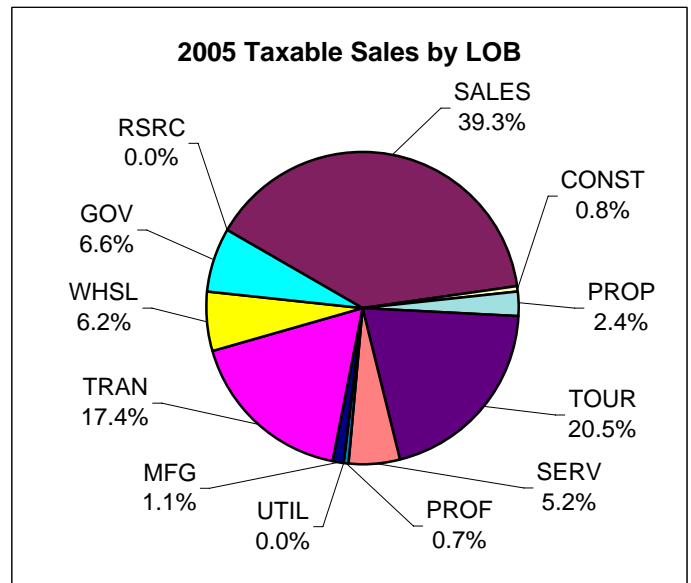

Chart 5.23

Seward TAXABLE Sales by Line of Business by Quarter - 2005 - in \$					
LOB	1st Quarter	2nd Quarter	3rd Quarter	4th Quarter	Total
Resource Production	7,711	6,943	6,937	15,264	36,855
Sales	4,814,504	9,813,123	14,252,751	5,676,326	34,556,704
Construction	148,395	195,772	167,034	153,919	665,120
Property	368,097	592,354	716,234	394,058	2,070,743
Tourism	1,488,859	5,330,324	9,928,141	1,256,703	18,004,027
Services	832,035	1,266,326	1,395,559	1,043,249	4,537,169
Professional	96,035	181,998	206,226	101,390	585,649
Utility	913	838	2,228	0	3,979
Manufacturing	103,151	327,422	440,617	66,981	938,171
Transportation & Warehousing	172,052	4,826,957	9,958,712	361,410	15,319,131
Wholesale	815,687	1,433,898	2,434,834	773,219	5,457,638
Government	1,243,546	1,391,654	1,614,203	1,584,694	5,834,097
TOTAL	10,090,985	25,367,609	41,123,476	11,427,213	88,009,283

Table 5.21

Seward Construction Permits

Seward 4th Quarter Permit VALUES by Type - 2001-2007 - in \$								
	2001	2002	2003	2004	2005	2006	2007	Annual Change
Residential New	300,000	0	0	0	1,500	0	0	0.0%
Residential Alter/Add	105,000	19,800	50,000	8,000	40,457	13,000	118,000	807.7%
Commercial New	0	2,100,000	5,000	0	60,000	1,896,300	18,000,000	849.22%
Commercial Alter/Add	587,000	113,000	517,500	251,350	4,900	35,000	21,500	-38.6%
Total	992,000	2,232,800	572,500	259,350	106,857	1,944,300	18,139,500	833.0%
Annual Change		125.1%	-74.4%	-54.7%	-58.8%	1719.5%	833.0%	

Table 5.22

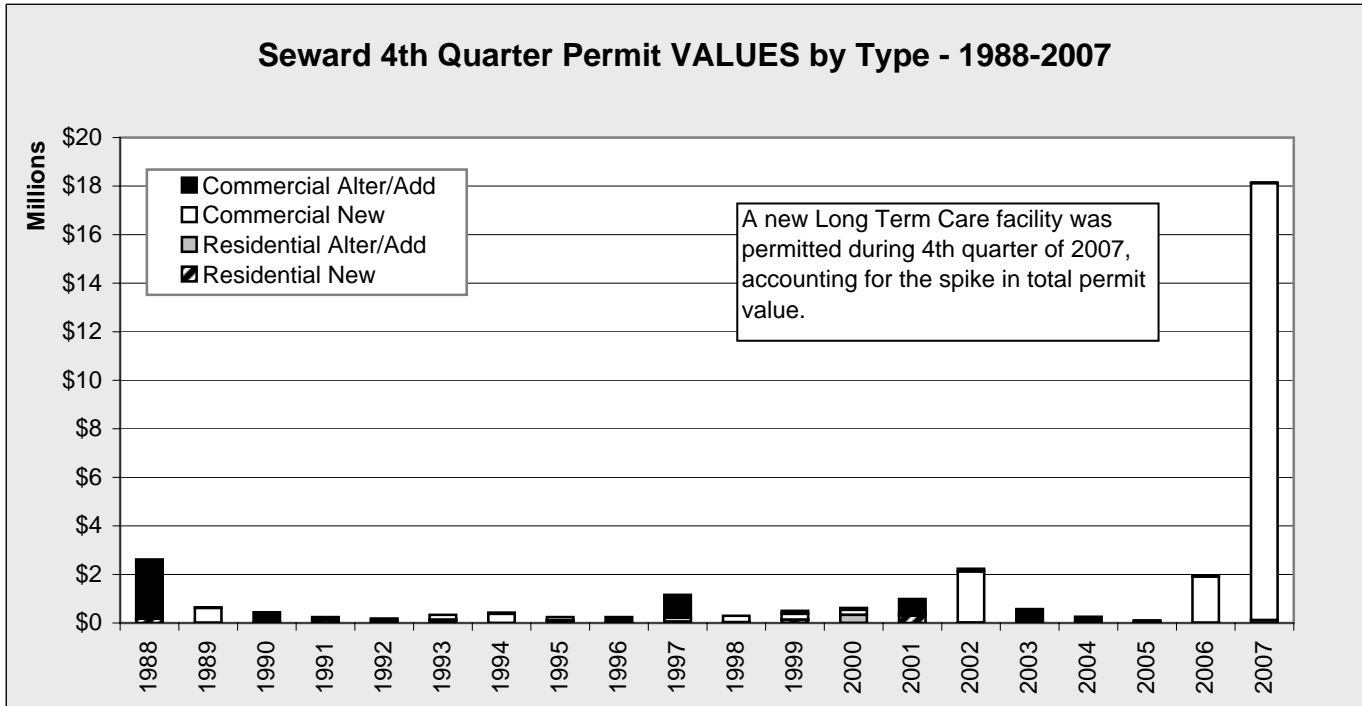

Chart 5.24

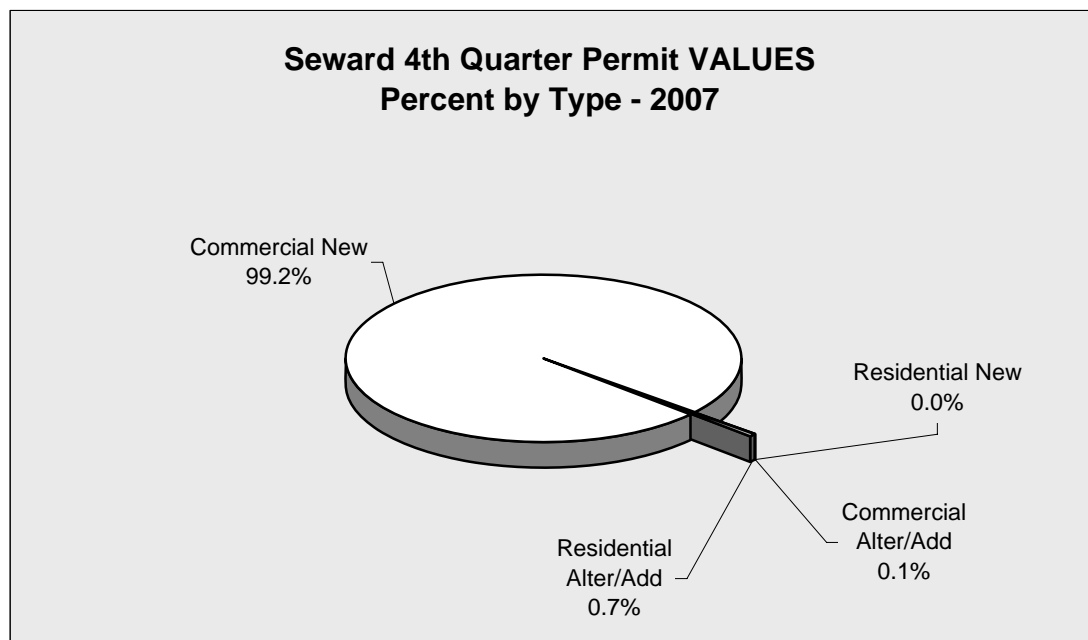

Chart 5.25

Seward Construction Permits

Seward 4th Quarter Permit VOLUME by Type - 2001-2007								
	2001	2002	2003	2004	2005	2006	2007	Annual Change
Residential New	2	0	0	0	1	0	0	0.0%
Residential Alter/Add	2	4	1	1	3	1	4	300.0%
Commercial New	0	3	1	0	1	4	1	-75.0%
Commercial Alter/Add	5	4	9	6	2	1	4	300.0%
Total	9	11	11	7	7	6	9	50.0%
Annual Change		22.2%	0.0%	-36.4%	0.0%	-14.3%	50.0%	

Table 5.23

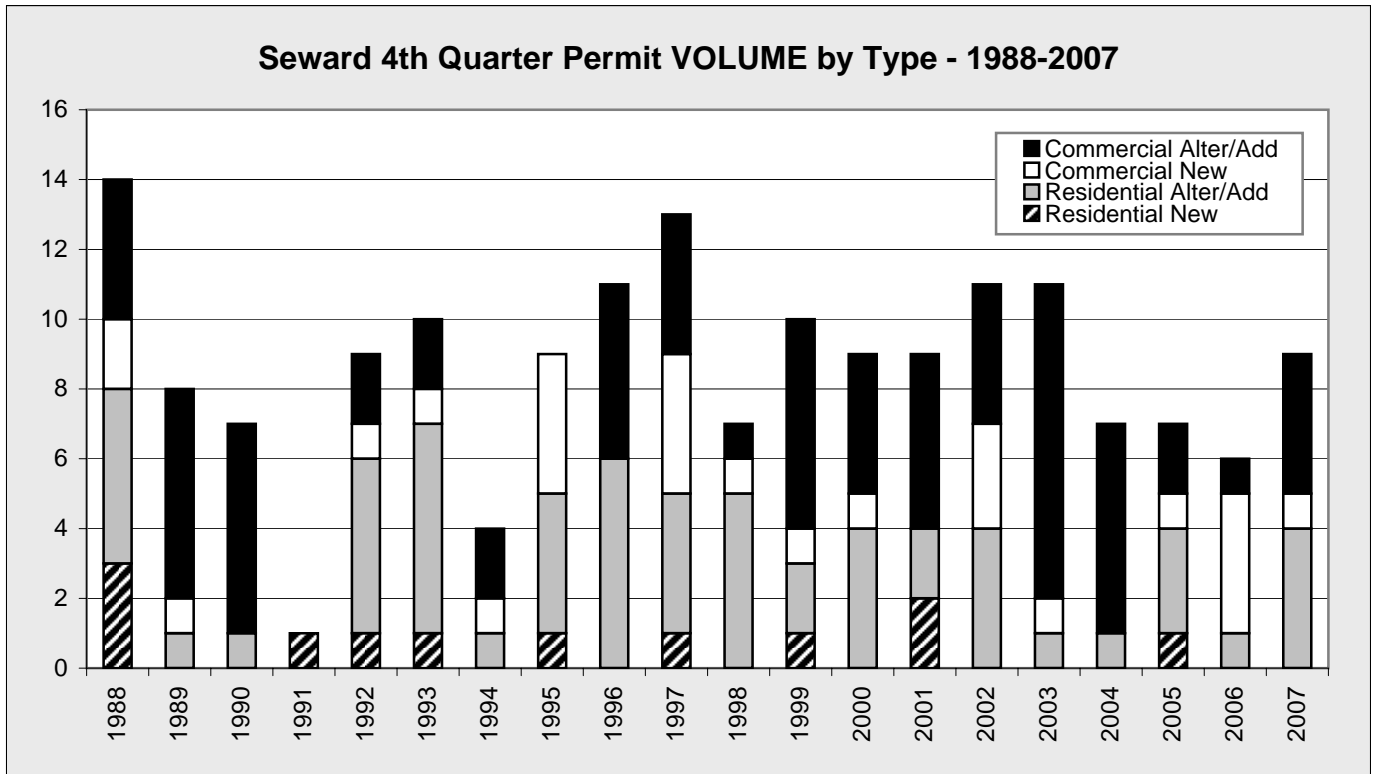

Chart 5.26

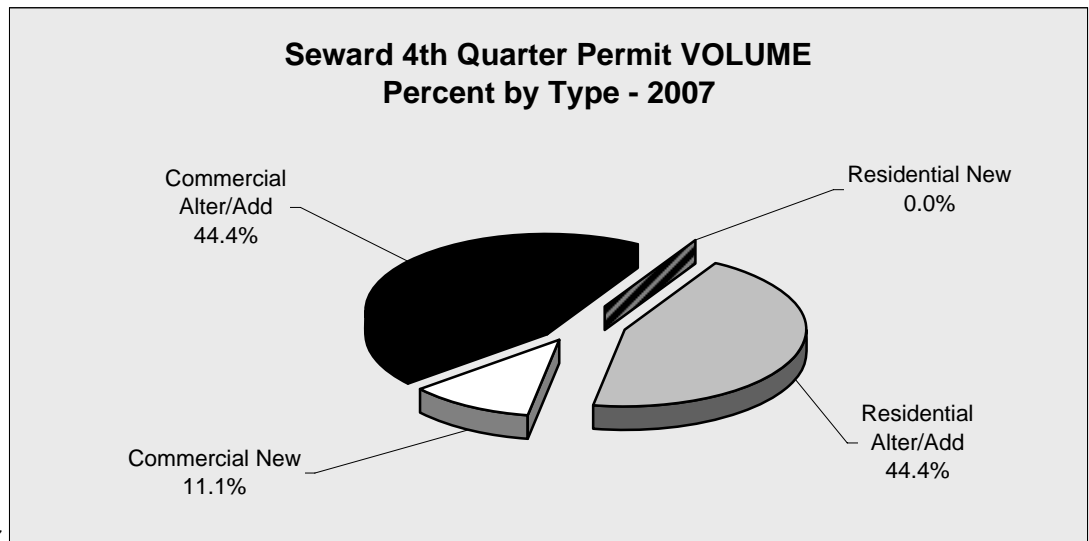

Chart 5.27

Seward Construction Permits

Seward Annual Permit VALUES by Type - 2001-2007 - in \$								
	2001	2002	2003	2004	2005	2006	2007	Annual Change
Residential New	450,000	725,000	1,077,500	2,130,000	1,767,500	1,118,000	252,354	-77.4%
Residential Alter/Add	344,214	242,008	294,500	500,400	134,738	86,392	177,400	105.3%
Commercial New	486,028	6,144,730	4,290,000	13,018,800	425,720	22,396,300	18,216,013	-18.67%
Commercial Alter/Add	1,436,739	798,965	2,320,765	2,061,950	535,185	1,936,557	2,450,158	26.5%
Total	2,716,981	7,910,703	7,982,765	17,711,150	2,863,143	25,537,249	21,095,925	-17.4%
Annual Change		191.2%	0.9%	121.9%	-83.8%	791.9%	-17.4%	

Table 5.24

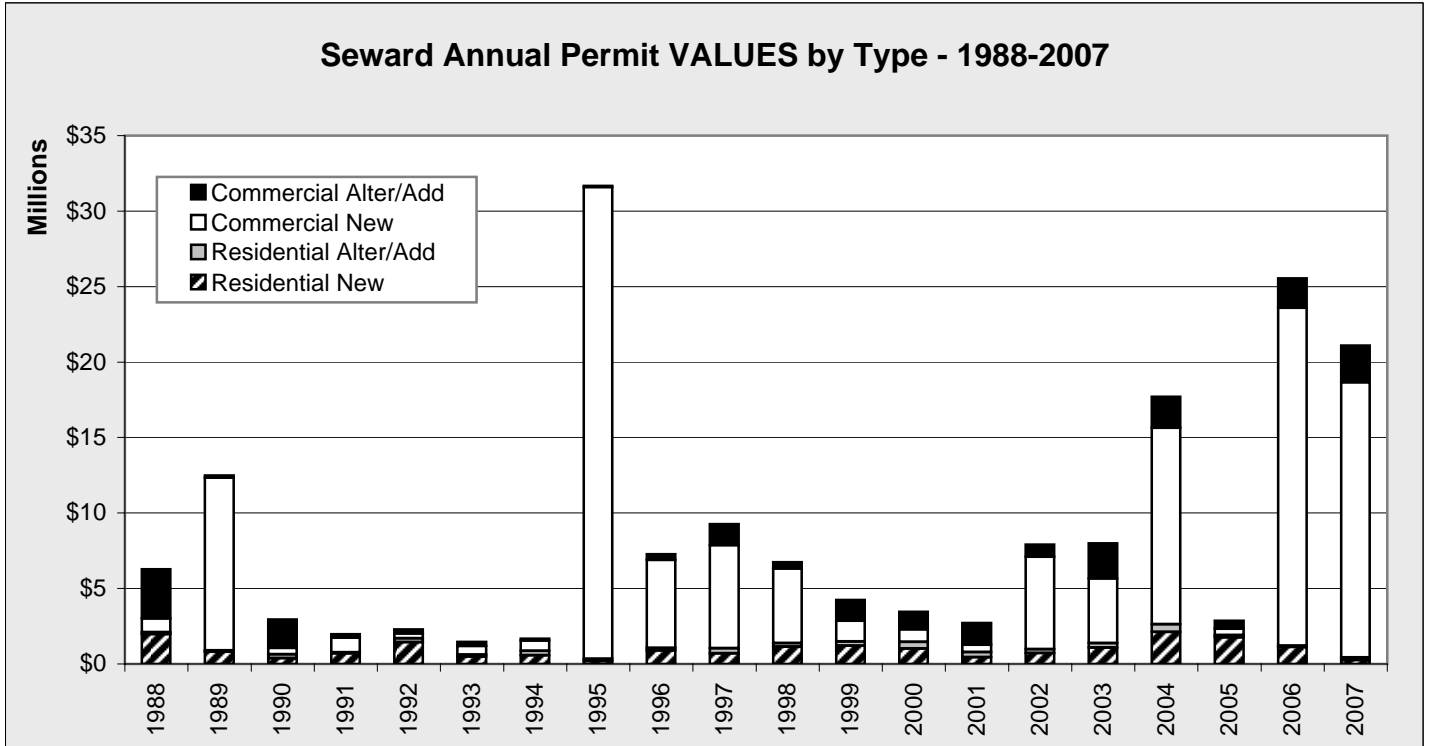

Chart 5.28

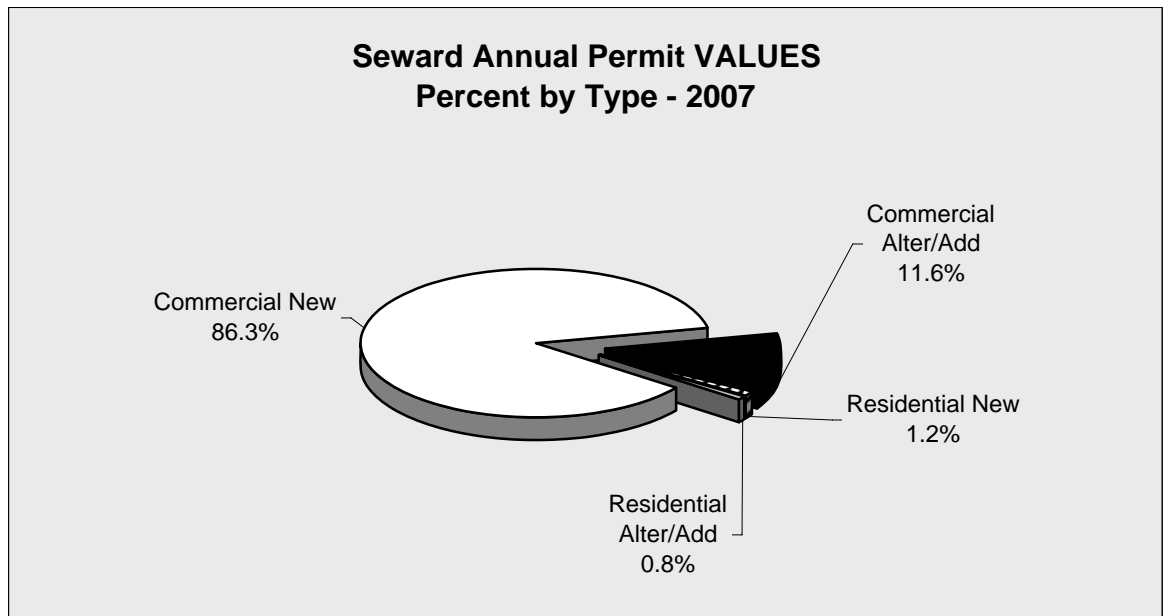

Chart 5.29

Seward Construction Permits

Seward Annual Permit VOLUME by Type - 2001-2007

	2001	2002	2003	2004	2005	2006	2007	Annual Change
Residential New	3	4	8	12	11	8	2	-75.0%
Residential Alter/Add	18	25	11	15	19	13	12	-7.7%
Commercial New	6	8	7	4	10	17	3	-82.4%
Commercial Alter/Add	21	27	24	23	14	17	20	17.6%
Total	48	64	50	54	54	55	37	-32.7%
Annual Change		33.3%	-21.9%	8.0%	0.0%	1.9%	-32.7%	

Table 5.25

Seward Annual Permit VOLUME by Type - 1988-2007

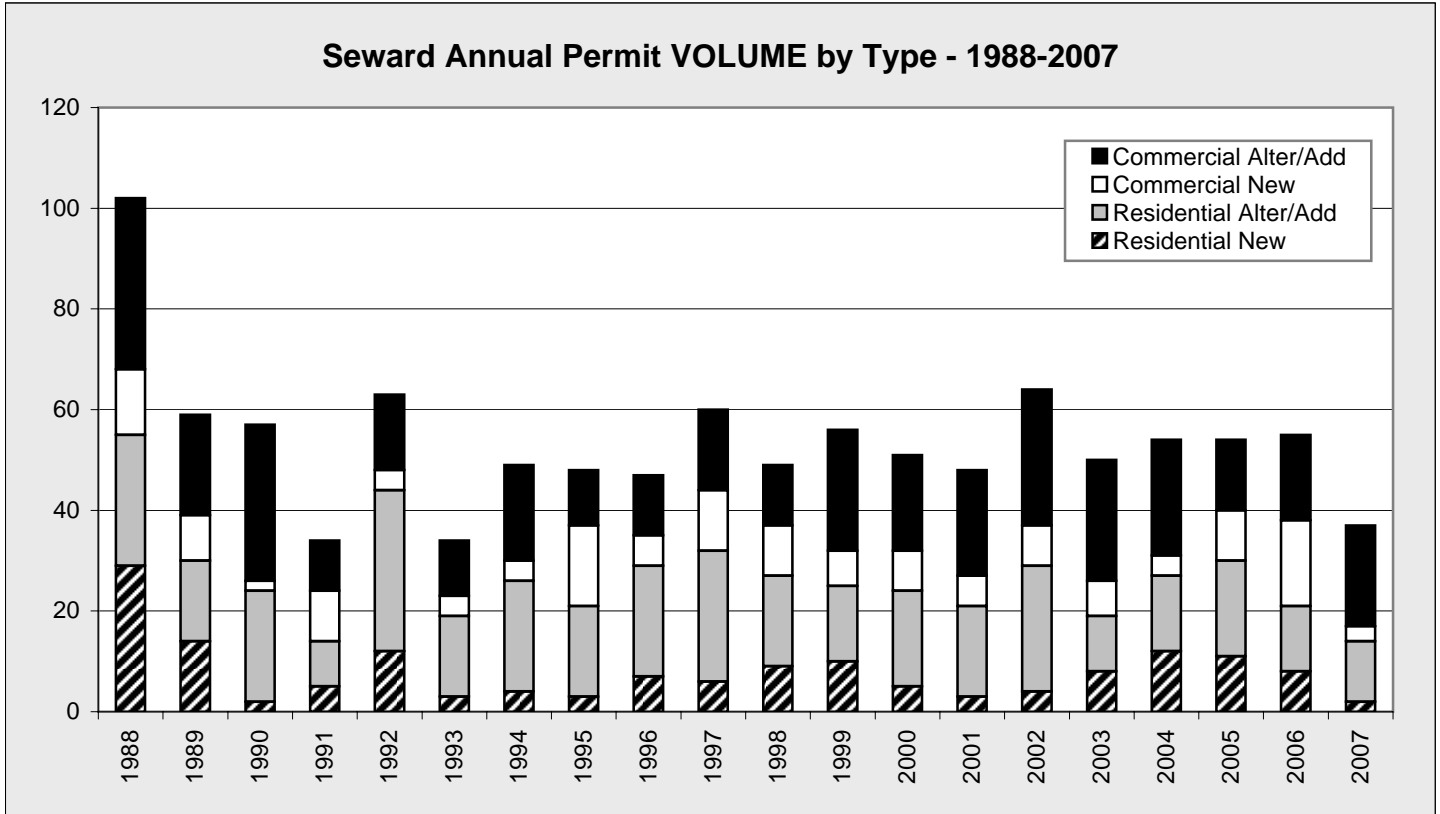

Chart 5.30

**Seward Annual Permit VOLUME
Percent by Type - 2007**

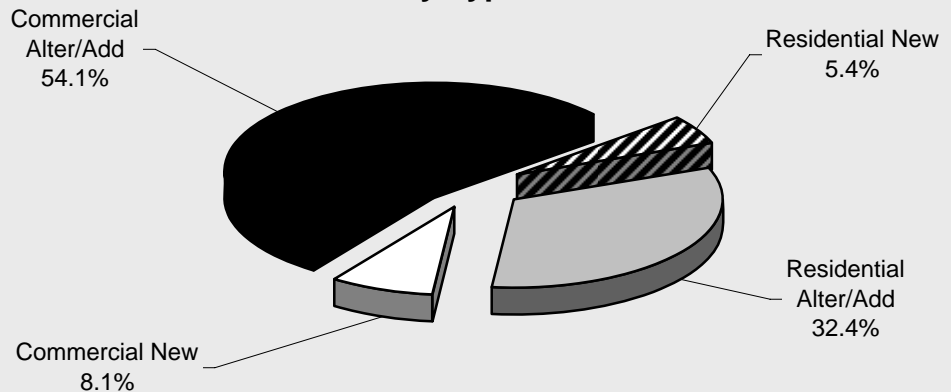

Chart 5.31

Seward Construction Permits

Seward Annual Permit VALUE by Type by Quarter - 2000-2007 - in \$					
	1st Quarter	2nd Quarter	3rd Quarter	4th Quarter	Total
2000					
Residential - New	230,000	530,000	263,000	0	1,023,000
Residential - Add/Alter	0	67,600	39,000	339,400	446,000
Commercial - New	85,000	210,000	330,000	200,000	825,000
Commercial - Add/Alter	40,300	957,800	79,465	80,000	1,157,565
TOTAL	355,300	1,765,400	711,465	619,400	3,451,565
2001					
Residential - New	0	0	150,000	300,000	450,000
Residential - Add/Alter	30,200	73,000	136,014	105,000	344,214
Commercial - New	0	155,000	331,028	0	486,028
Commercial - Add/Alter	386,500	438,239	25,000	587,000	1,436,739
TOTAL	416,700	666,239	642,042	992,000	2,716,981
2002					
Residential - New	120,000	400,000	205,000	0	725,000
Residential - Add/Alter	25,496	169,157	27,555	19,800	242,008
Commercial - New	0	3,294,730	750,000	2,100,000	6,144,730
Commercial - Add/Alter	335,944	25,000	325,021	113,000	798,965
TOTAL	481,440	3,888,887	1,307,576	2,232,800	7,910,703
2003					
Residential - New	118,000	215,000	744,500	0	1,077,500
Residential - Add/Alter	57,500	100,000	87,000	50,000	294,500
Commercial - New	72,000	3,313,000	900,000	5,000	4,290,000
Commercial - Add/Alter	1,657,855	44,010	101,400	517,500	2,320,765
TOTAL	1,905,355	3,672,010	1,832,900	572,500	7,982,765
2004					
Residential - New	0	873,000	1,257,000	0	2,130,000
Residential - Add/Alter	48,000	144,900	299,500	8,000	500,400
Commercial - New	7,500,000	5,000,000	518,800	0	13,018,800
Commercial - Add/Alter	193,600	1,426,000	191,000	251,350	2,061,950
TOTAL	7,741,600	7,443,900	2,266,300	259,350	17,711,150
2005					
Residential - New	923,000	388,000	455,000	1,500	1,767,500
Residential - Add/Alter	3,300	84,220	6,761	40,457	134,738
Commercial - New	6,000	271,320	88,400	60,000	425,720
Commercial - Add/Alter	240,000	15,000	275,285	4,900	535,185
TOTAL	1,172,300	758,540	825,446	106,857	2,863,143
2006					
Residential - New	0	415,000	703,000	0	1,118,000
Residential - Add/Alter	1,000	65,200	7,192	13,000	86,392
Commercial - New	0	800,000	19,700,000	1,896,300	22,396,300
Commercial - Add/Alter	621,217	904,472	375,868	35,000	1,936,557
TOTAL	622,217	2,184,672	20,786,060	1,944,300	25,537,249
2007					
Residential - New	0	82,354	170,000	0	252,354
Residential - Add/Alter	0	13,000	46,400	118,000	177,400
Commercial - New	208,513	0	7,500	18,000,000	18,216,013
Commercial - Add/Alter	594,725	1,792,933	41,000	21,500	2,450,158
TOTAL	803,238	1,888,287	264,900	18,139,500	21,095,925

Table 5.26

Seward Construction Permits

Seward Annual Permit VOLUME by Type by Quarter - 2000-2007					
	1st Quarter	2nd Quarter	3rd Quarter	4th Quarter	Total
2000					
Residential - New	1	2	2	0	5
Residential - Add/Alter	0	8	7	4	19
Commercial - New	1	3	3	1	8
Commercial - Add/Alter	3	7	5	4	19
TOTAL	5	20	17	9	51
2001					
Residential - New	0	0	1	2	3
Residential - Add/Alter	4	3	9	2	18
Commercial - New	0	3	3	0	6
Commercial - Add/Alter	7	8	1	5	21
TOTAL	11	14	14	9	48
2002					
Residential - New	1	1	2	0	4
Residential - Add/Alter	3	15	3	4	25
Commercial - New	0	4	1	3	8
Commercial - Add/Alter	6	9	8	4	27
TOTAL	10	29	14	11	64
2003					
Residential - New	1	2	5	0	8
Residential - Add/Alter	2	3	5	1	11
Commercial - New	1	4	1	1	7
Commercial - Add/Alter	7	4	4	9	24
TOTAL	11	13	15	11	50
2004					
Residential - New	0	4	8	0	12
Residential - Add/Alter	2	7	5	1	15
Commercial - New	1	1	2	0	4
Commercial - Add/Alter	4	9	4	6	23
TOTAL	7	21	19	7	54
2005					
Residential - New	4	3	3	1	11
Residential - Add/Alter	2	9	5	3	19
Commercial - New	2	5	2	1	10
Commercial - Add/Alter	4	2	6	2	14
TOTAL	12	19	16	7	54
2006					
Residential - New	0	3	5	0	8
Residential - Add/Alter	1	7	4	1	13
Commercial - New	0	11	2	4	17
Commercial - Add/Alter	6	2	8	1	17
TOTAL	7	23	19	6	55
2007					
Residential - New	0	1	1	0	2
Residential - Add/Alter	0	2	6	4	12
Commercial - New	1	0	1	1	3
Commercial - Add/Alter	6	8	2	4	20
TOTAL	7	11	10	9	37

Table 5.27

Soldotna Sales

Soldotna Annual Gross Sales by Quarter - in \$

	1st Quarter	2nd Quarter	3rd Quarter	4th Quarter	Total	Annual Change
1991	31,483,390	43,034,736	51,189,559	45,227,061	170,934,746	
1992	32,703,158	42,836,530	48,640,661	40,776,238	164,956,587	-3.5%
1993	30,712,947	42,532,997	49,778,913	42,515,059	165,539,916	0.4%
1994	34,749,855	49,616,019	58,879,212	51,364,458	194,609,544	17.6%
1995	40,627,047	53,363,505	64,724,383	54,078,654	212,793,589	9.3%
1996	44,155,649	54,086,799	66,745,597	53,262,403	218,250,448	2.6%
1997	43,136,587	56,048,000	71,982,003	61,417,298	232,583,888	6.6%
1998	46,245,330	61,860,448	76,091,735	66,596,151	250,793,664	7.8%
1999	51,429,980	67,874,942	87,704,206	70,579,609	277,588,737	10.7%
2000	55,201,896	72,515,215	89,530,301	72,007,899	289,255,311	4.2%
2001	60,802,277	75,042,511	95,670,432	77,603,011	309,118,231	6.9%
2002	62,331,750	79,762,672	103,625,416	80,180,782	325,900,620	5.4%
2003	64,254,952	85,227,616	106,268,314	82,155,118	337,906,000	3.7%
2004	69,929,668	89,310,129	107,194,955	94,820,763	361,255,515	6.9%
2005	65,956,145	87,639,989	113,946,286	128,499,671	396,042,091	9.6%
2006	72,457,043	99,023,371	121,179,864	139,953,787	432,614,065	9.2%
2007	78,834,705	102,626,562	130,113,093	106,496,374	418,070,734	-3.4%
Annual Change	8.8%	3.6%	7.4%	-23.9%	-3.4%	

Table 6.1

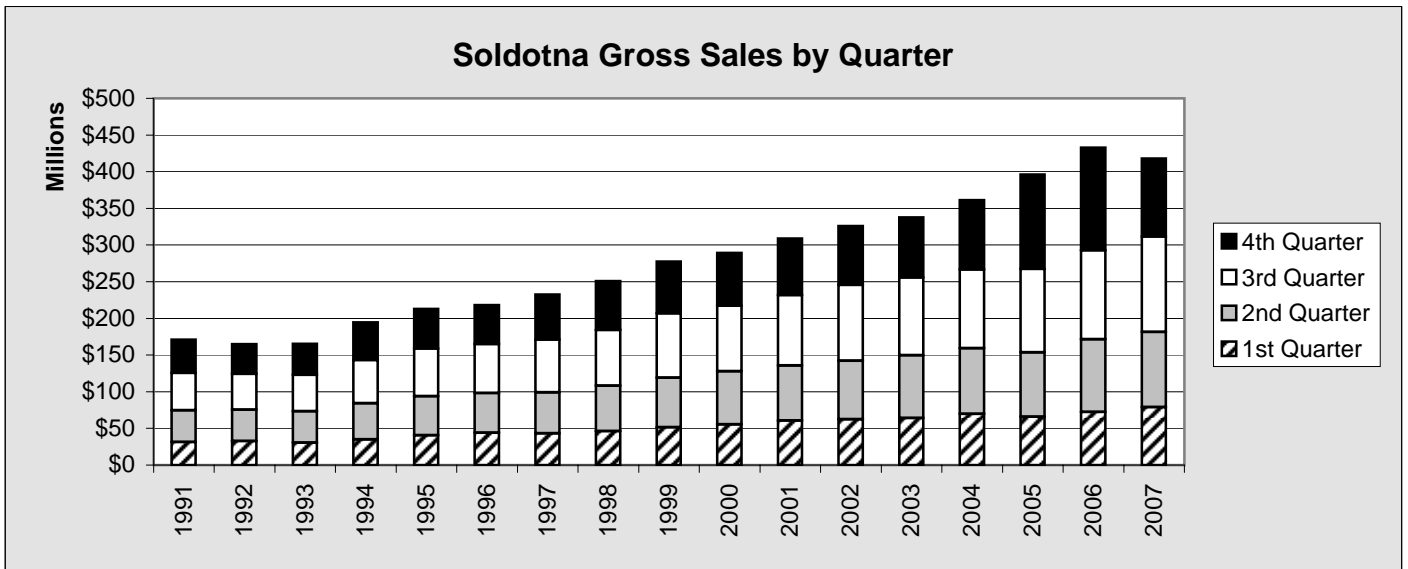

Chart 6.1

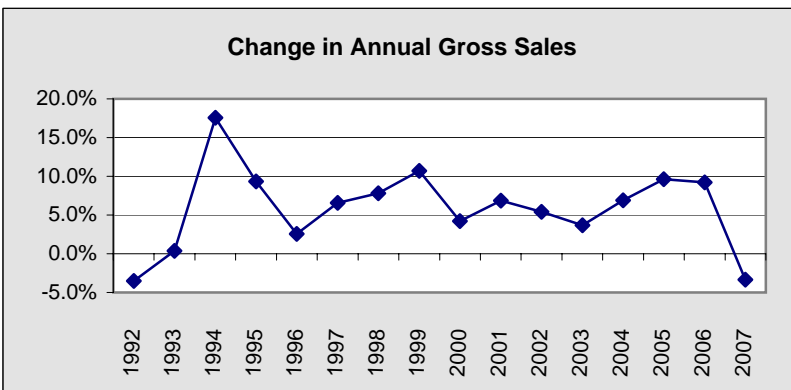

Chart 6.2

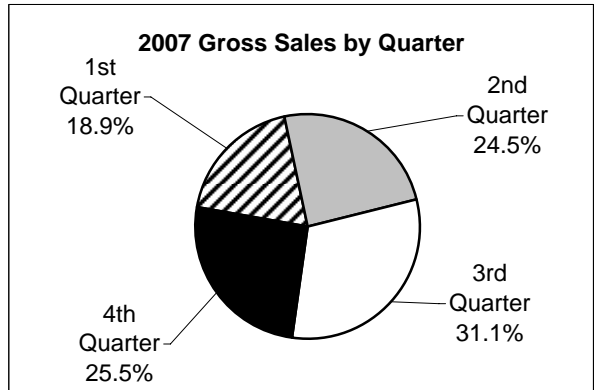

Chart 6.3

Soldotna Sales

Soldotna Annual Taxable Sales by Quarter - in \$

	1st Quarter	2nd Quarter	3rd Quarter	4th Quarter	Total	Annual Change
1991	18,135,279	24,291,040	28,478,502	24,327,043	95,231,864	
1992	19,187,594	24,421,393	30,751,951	24,733,449	99,094,387	4.1%
1993	19,138,120	25,917,384	29,216,512	24,082,915	98,354,931	-0.7%
1994	19,531,203	31,266,887	38,337,634	30,566,757	119,702,481	21.7%
1995	23,569,520	32,168,958	41,181,901	32,148,717	129,069,096	7.8%
1996	26,114,766	32,996,657	41,676,112	32,537,647	133,325,182	3.3%
1997	26,296,124	33,910,547	44,323,596	35,806,409	140,336,676	5.3%
1998	27,184,841	37,240,899	46,529,812	36,834,109	147,789,661	5.3%
1999	28,439,928	38,205,240	50,500,561	38,807,035	155,952,764	5.5%
2000	29,664,420	38,766,616	50,523,183	40,481,909	159,436,128	2.2%
2001	32,492,377	42,914,074	54,143,248	42,868,739	172,418,438	8.1%
2002	33,736,608	43,504,958	57,489,123	42,248,703	176,979,392	2.6%
2003	34,464,122	47,026,039	62,579,271	46,558,340	190,627,772	7.7%
2004	37,385,342	49,011,743	66,179,805	47,479,294	200,056,184	4.9%
2005	38,714,672	52,145,244	69,956,303	50,403,476	211,219,695	5.6%
2006	42,117,457	55,444,444	75,550,142	54,172,740	227,284,783	7.6%
2007	45,456,607	59,196,308	80,207,158	56,913,223	241,773,296	6.4%
Annual Change	7.9%	6.8%	6.2%	5.06%	6.4%	

Table 6.2

Soldotna Taxable Sales by Quarter

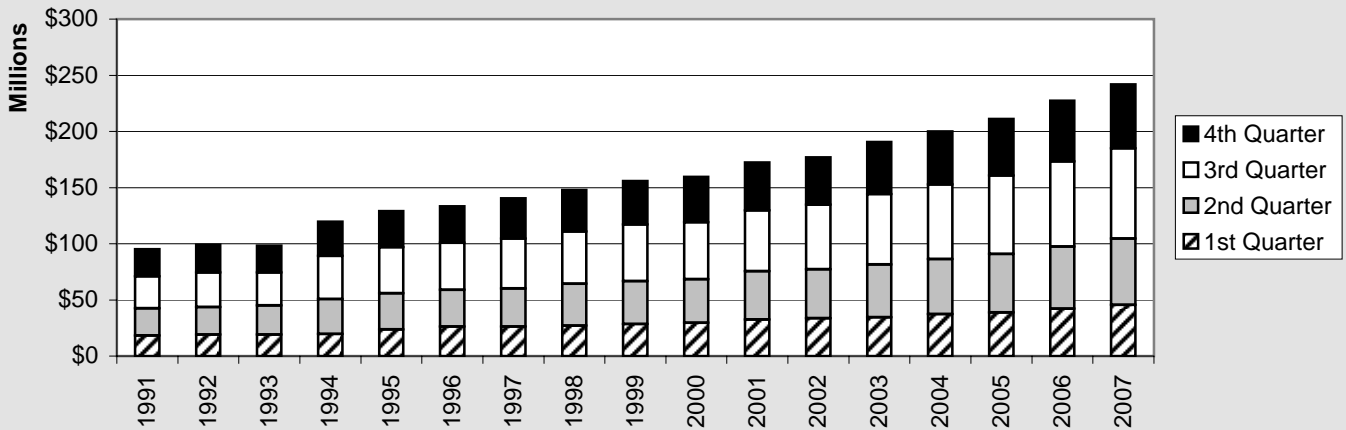

Chart 6.4

Change in Annual Taxable Sales

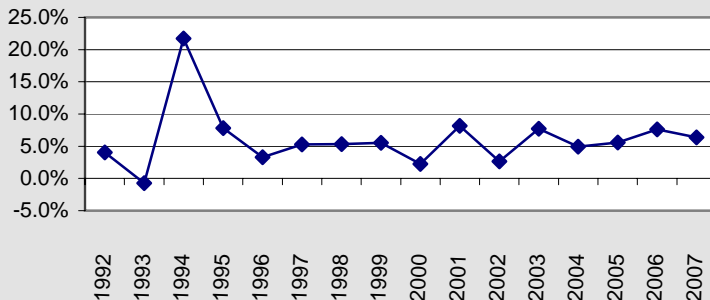

Chart 6.5

2007 Taxable Sales by Quarter

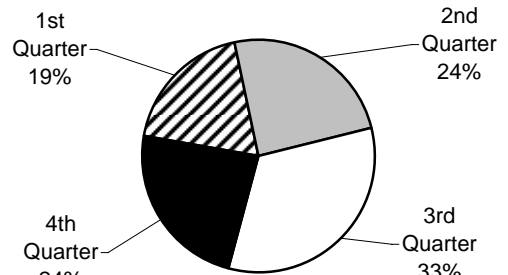

Chart 6.6

Soldotna Sales

Soldotna Annual Nontaxable Sales by Quarter - in \$						
	1st Quarter	2nd Quarter	3rd Quarter	4th Quarter	Total	Annual Change
1991	13,348,111	18,743,696	22,711,057	20,900,018	75,702,882	
1992	13,515,564	18,415,137	17,888,710	16,042,789	65,862,200	-13.0%
1993	11,574,827	16,615,613	20,562,401	18,432,144	67,184,985	2.0%
1994	15,218,652	18,349,132	20,541,578	20,797,701	74,907,063	11.5%
1995	17,057,527	21,194,547	23,542,482	21,929,937	83,724,493	11.8%
1996	18,040,883	21,090,142	25,069,485	20,724,756	84,925,266	1.4%
1997	16,840,463	22,137,453	27,658,407	25,610,889	92,247,212	8.6%
1998	19,060,489	24,619,549	29,561,923	29,762,042	103,004,003	11.7%
1999	22,990,052	29,669,702	37,203,645	31,772,574	121,635,973	18.1%
2000	25,537,476	33,748,599	39,007,118	31,525,990	129,819,183	6.7%
2001	28,309,900	32,128,437	41,527,184	34,734,272	136,699,793	5.3%
2002	28,595,142	36,257,714	46,136,293	37,932,079	148,921,228	8.9%
2003	29,790,830	38,201,577	43,689,043	35,596,778	147,278,228	-1.1%
2004	32,544,326	40,298,386	41,015,150	47,341,469	161,199,331	9.5%
2005	27,241,473	35,494,745	43,989,983	78,096,195	184,822,396	14.7%
2006	30,339,586	43,578,927	45,629,722	85,781,047	205,329,282	11.1%
2007	33,378,098	43,430,254	49,905,935	49,583,151	176,297,438	-14.1%
Annual Change	10.0%	-0.3%	9.4%	-42.2%	-14.1%	

Table 6.3

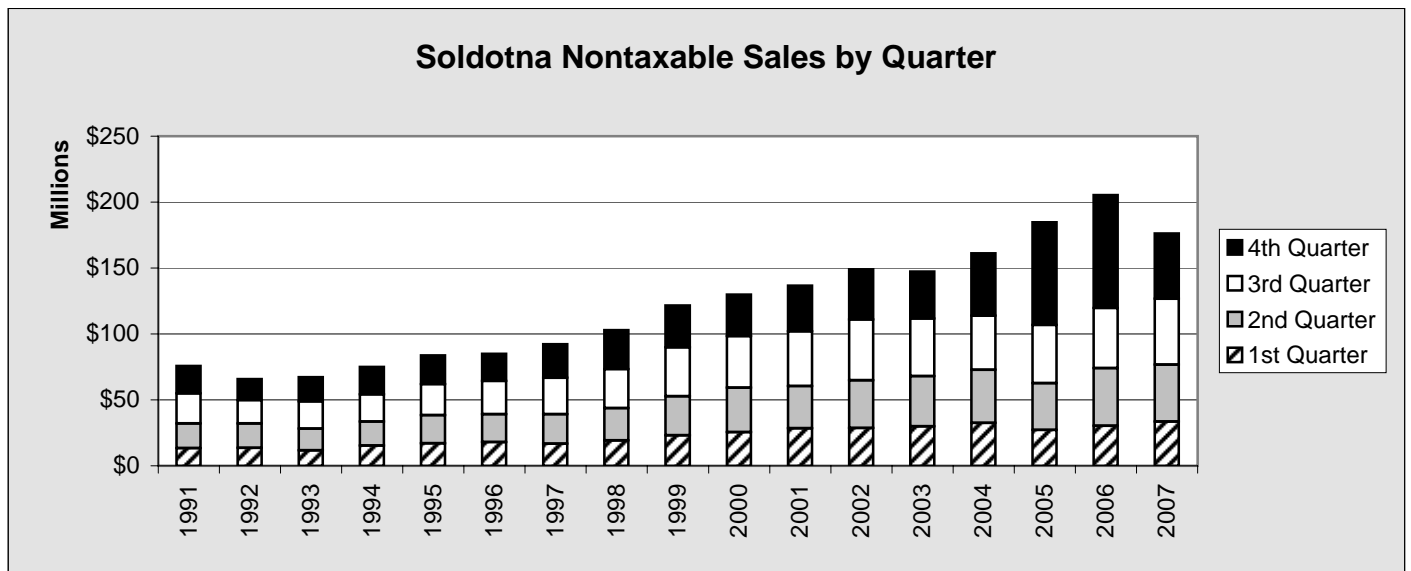

Chart 6.7

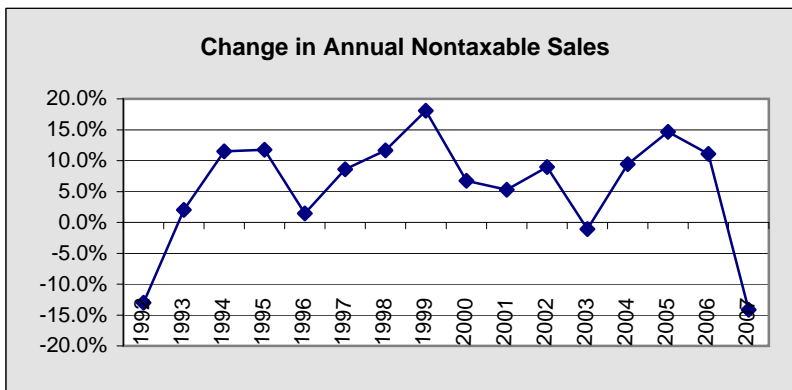

Chart 6.8

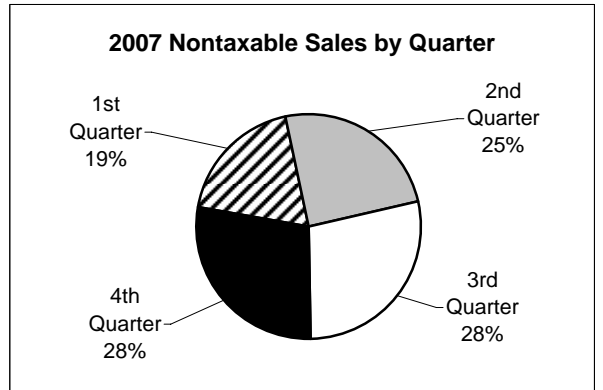

Chart 6.9

Soldotna Sales

Soldotna 4th Quarter GROSS Sales by Line of Business - 2002-2007 - in \$								
LOB	2002	2003	2004	2005	2006	2007	Annual Percent Change	Annual Amount Change
RSRC	215,587	99,893	160,292	16,081	147,104	45,081	-69.4%	-102,023
SALES	44,329,000	49,325,952	52,266,062	49,821,411	55,775,283	60,383,242	8.3%	4,607,959
CONST	5,466,801	5,414,084	9,177,664	43,423,707	46,179,935	12,218,031	-73.5%	-33,961,904
PROP	3,546,485	4,155,838	4,606,510	3,760,500	5,244,874	4,994,953	-4.8%	-249,921
TOUR	4,542,245	4,896,894	4,989,234	5,258,468	5,450,351	4,655,921	-14.6%	-794,430
SERV	4,029,678	4,423,141	4,870,006	4,913,564	5,945,278	8,065,376	35.7%	2,120,098
PROF	2,183,452	2,501,007	7,214,508	7,694,574	7,666,547	5,989,721	-21.9%	-1,676,826
UTIL	1,793,627	1,840,025	1,936,789	2,296,442	2,765,194	2,491,946	-9.9%	-273,248
MANU	1,538,255	2,114,133	1,827,915	2,996,668	2,750,085	2,569,265	-6.6%	-180,820
TRAN	216,092	123,393	891,172	1,414,152	1,271,545	1,593,173	25.3%	321,628
WHLS	12,125,210	7,054,128	6,661,231	6,667,238	6,494,786	3,223,828	-50.4%	-3,270,958
GOV	194,350	206,630	219,380	236,866	262,805	265,837	1.2%	3,032
TOTAL	80,180,782	82,155,118	94,820,763	128,499,671	139,953,787	106,496,374	-23.9%	-33,457,413

Table 6.4

For complete listing of Lines of Business, see page 13

Soldotna 4th Quarter GROSS Sales History	
2002	80,180,782
2003	82,155,118
2004	94,820,763
2005	128,499,671
2006	139,953,787
2007	106,496,374

Table 6.5

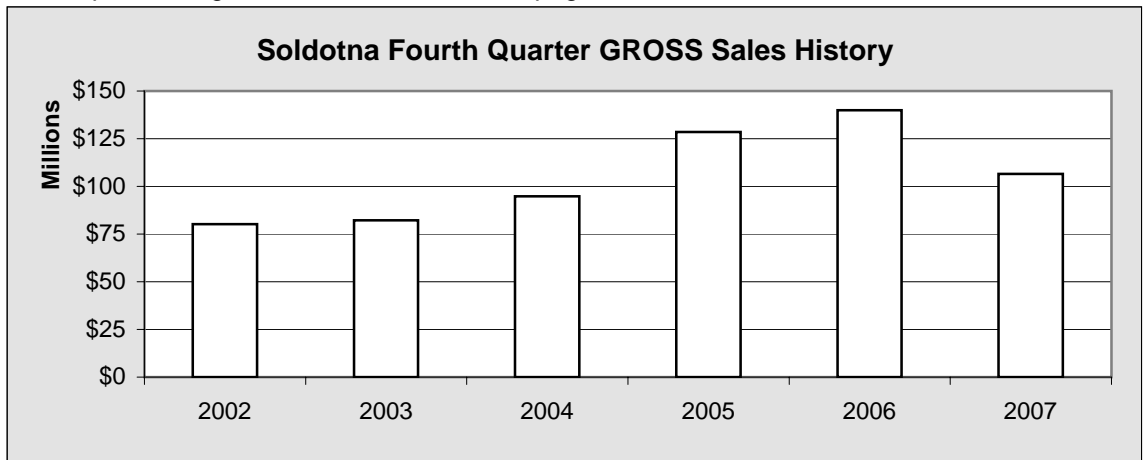

Chart 6.10

Soldotna Five Year Change 4th Quarter GROSS Sales		
LOB	2002	2007
RSRC	215,587	45,081
SALES	44,329,000	60,383,242
CONST	5,466,801	12,218,031
PROP	3,546,485	4,994,953
TOUR	4,542,245	4,655,921
SERV	4,029,678	8,065,376
PROF	2,183,452	5,989,721
UTIL	1,793,627	2,491,946
MANU	1,538,255	2,569,265
TRAN	216,092	1,593,173
WHLS	12,125,210	3,223,828
GOV	194,350	265,837

Table 6.6

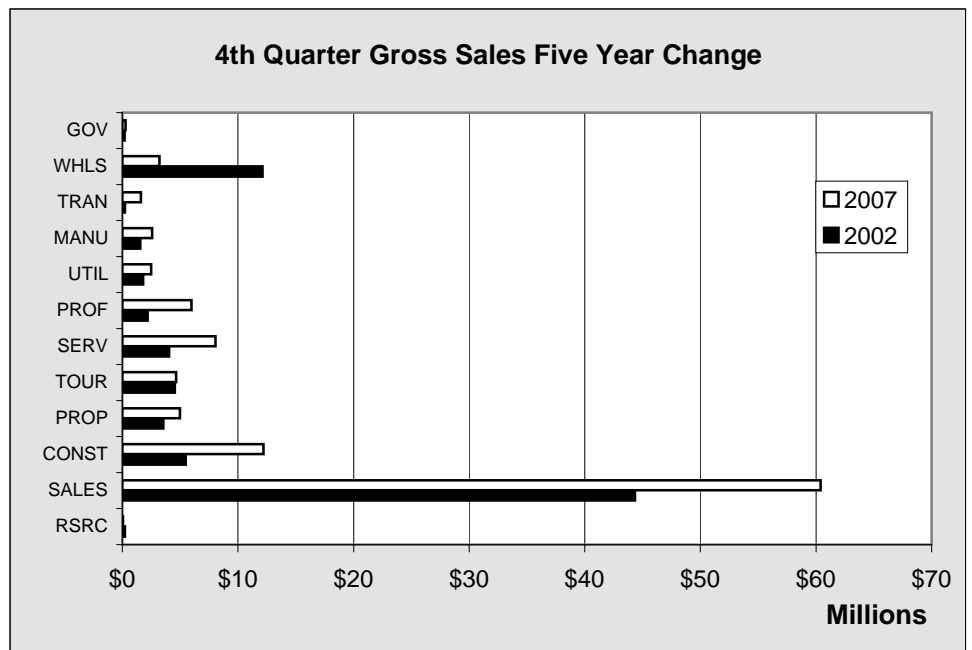

Chart 6.11

Soldotna Sales

Soldotna 4th Quarter TAXABLE Sales by Line of Business - 2002-2007 - in \$								
LOB	2002	2003	2004	2005	2006	2007	Annual Percent Change	Annual Amount Change
RSRC	17,609	9,590	9,957	5,653	6,847	5,716	-16.5%	-1,131
SALES	29,749,536	33,784,456	34,447,801	35,997,976	39,077,825	42,102,040	7.7%	3,024,215
CONST	262,867	273,964	253,803	243,720	247,023	342,701	38.7%	95,678
PROP	1,743,231	1,421,468	1,615,327	1,676,421	1,685,869	2,217,925	31.6%	532,056
TOUR	4,290,674	4,624,160	4,695,583	4,994,629	5,111,337	4,314,547	-15.6%	-796,790
SERV	3,392,300	3,549,999	3,593,590	3,690,082	4,351,570	4,624,481	6.3%	272,911
PROF	764,349	784,542	730,218	706,730	818,091	848,590	3.7%	30,499
UTIL	953,589	1,003,838	1,062,389	1,231,331	1,226,692	1,133,249	-7.6%	-93,443
MANU	138,611	126,482	112,023	823,816	642,127	231,868	-63.9%	-410,259
TRAN	103,858	48,414	56,680	91,229	87,541	51,873	-40.7%	-35,668
WHLS	659,214	750,193	710,241	734,824	692,442	820,302	18.5%	127,860
GOV	172,865	181,234	191,682	207,065	225,376	219,931	-2.4%	-5,445
TOTAL	42,248,703	46,558,340	47,479,294	50,403,476	54,172,740	56,913,223	5.1%	2,740,483

Table 6.7

For complete listing of Lines of Business, see page 13

Soldotna 4th Quarter TAXABLE Sales History	
2002	42,248,703
2003	46,558,340
2004	47,479,294
2005	50,403,476
2006	54,172,740
2007	56,913,223

Table 6.8

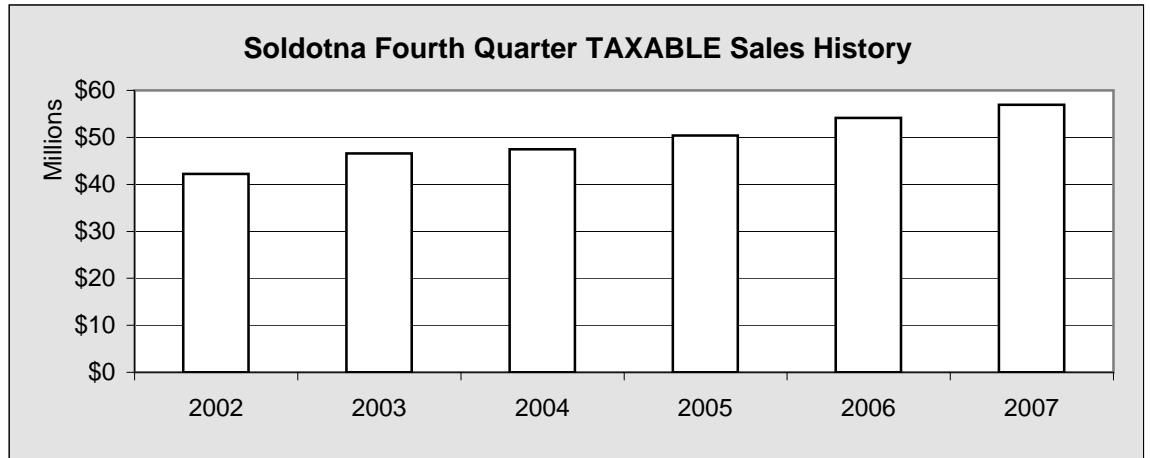

Chart 6.12

Soldotna Five Year Change 4th Quarter TAXABLE Sales		
LOB	2002	2007
RSRC	17,609	5,716
SALES	29,749,536	42,102,040
CONST	262,867	342,701
PROP	1,743,231	2,217,925
TOUR	4,290,674	4,314,547
SERV	3,392,300	4,624,481
PROF	764,349	848,590
UTIL	953,589	1,133,249
MANU	138,611	231,868
TRAN	103,858	51,873
WHLS	659,214	820,302
GOV	172,865	219,931

Table 6.9

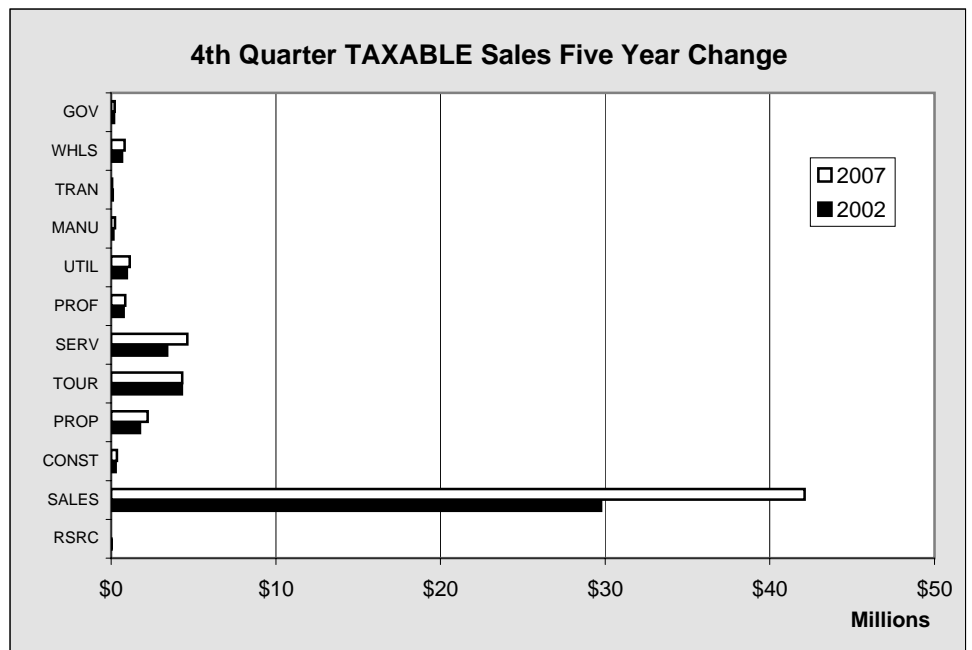

Chart 6.13

Soldotna Sales

Soldotna Annual GROSS Sales by Line of Business - 2002-2007 - in \$

LOB	2002	2003	2004	2005	2006	2007	Annual Percent Change	Annual Amount Change
RSRC	480,520	425,908	501,940	439,049	236,529	935,597	295.6%	699,068
SALES	185,272,417	199,946,811	210,983,917	217,734,439	228,060,610	244,642,968	7.3%	16,582,358
CONST	21,223,507	18,482,937	25,891,445	60,586,340	73,481,861	36,797,190	-49.9%	-36,684,671
PROP	14,063,839	15,015,437	15,976,516	15,617,820	18,418,400	18,632,160	1.2%	213,760
TOUR	22,103,126	23,229,127	24,993,202	26,555,014	28,234,311	27,262,370	-3.4%	-971,941
SERV	16,391,005	17,874,276	19,672,809	19,321,846	23,215,267	31,962,045	37.7%	8,746,778
PROF	8,912,354	10,359,952	13,652,017	14,717,603	16,098,356	14,869,541	-7.6%	-1,228,815
UTIL	7,794,137	6,868,788	7,753,204	8,447,844	9,749,393	9,955,710	2.1%	206,317
MANU	8,820,408	10,450,535	7,202,898	10,076,540	10,866,104	11,609,987	6.8%	743,883
TRAN	2,262,620	1,879,085	4,677,079	6,511,215	7,676,962	7,267,363	-5.3%	-409,599
WHLS	37,743,451	32,515,653	28,984,856	15,028,231	15,456,999	12,988,274	-16.0%	-2,468,725
GOV	833,236	857,491	965,632	1,006,150	1,119,273	1,147,529	2.5%	28,256
TOTAL	325,900,620	337,906,000	361,255,515	396,042,091	432,614,065	418,070,734	-3.4%	-14,543,331

Table 6.10

For complete listing of Lines of Business, see page 13

Soldotna Annual GROSS Sales History	
2002	325,900,620
2003	337,906,000
2004	361,255,515
2005	396,042,091
2006	432,614,065
2007	418,070,734

Table 6.11

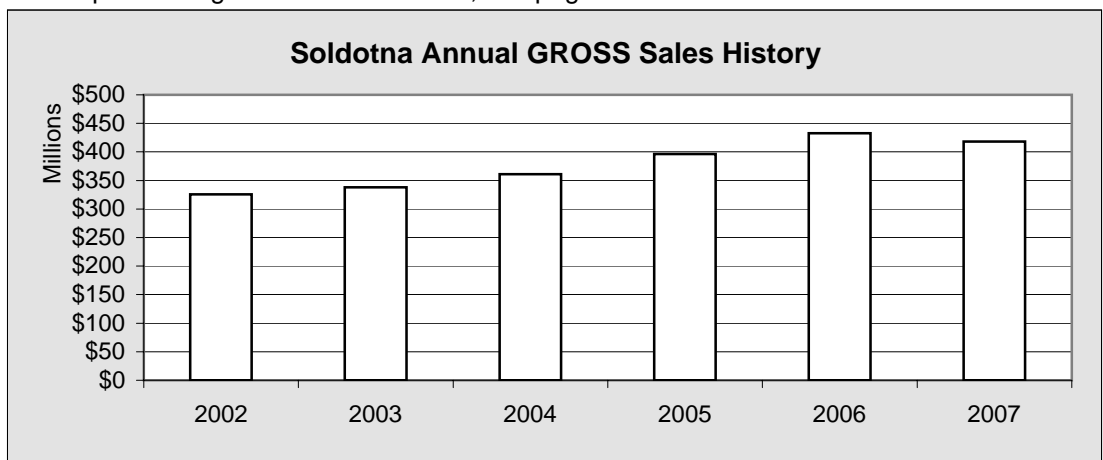

Chart 6.14

Five Year Change Annual GROSS Sales		
LOB	2002	2007
RSRC	480,520	935,597
SALES	185,272,417	244,642,968
CONST	21,223,507	36,797,190
PROP	14,063,839	18,632,160
TOUR	22,103,126	27,262,370
SERV	16,391,005	31,962,045
PROF	8,912,354	14,869,541
UTIL	7,794,137	9,955,710
MANU	8,820,408	11,609,987
TRAN	2,262,620	7,267,363
WHLS	37,743,451	12,988,274
GOV	833,236	1,147,529

Table 6.12

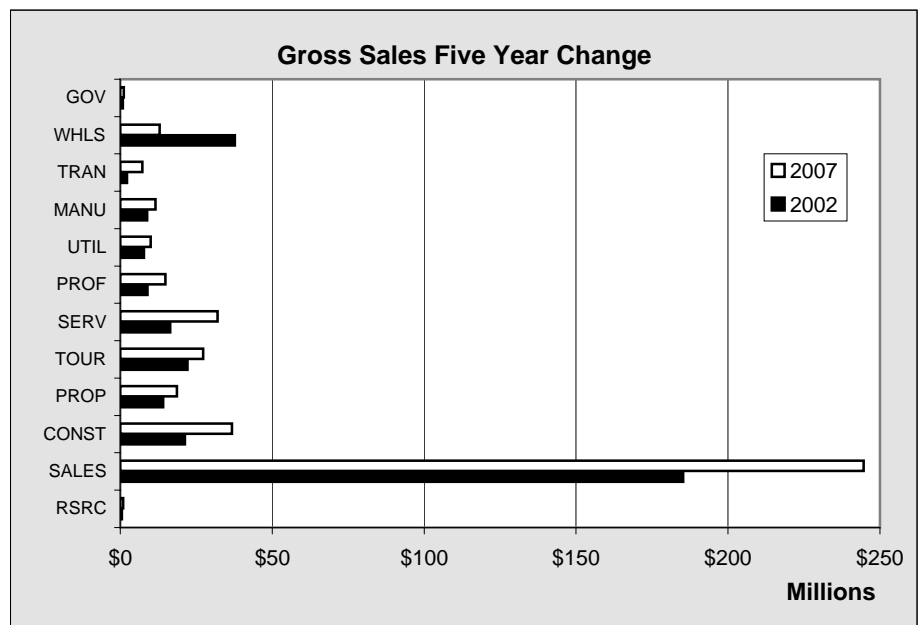

Chart 6.15

Soldotna Sales

Soldotna Annual TAXABLE Sales by Line of Business - 2002-2007 - in \$								
LOB	2002	2003	2004	2005	2006	2007	Annual Percent Change	Annual Amount Change
RSRC	47,017	53,520	24,943	29,575	40,630	47,330	16.5%	6,700
SALES	122,443,869	134,519,729	141,398,104	150,227,961	160,101,830	173,396,532	8.3%	13,294,702
CONST	1,035,905	1,110,826	1,041,384	999,058	938,647	1,051,570	12.0%	112,923
PROP	7,006,887	6,186,122	6,512,701	6,544,146	6,784,253	7,759,987	14.4%	975,734
TOUR	20,894,830	21,925,174	23,529,251	24,949,860	26,186,900	25,397,357	-3.0%	-789,543
SERV	13,615,149	14,696,554	15,179,126	14,783,576	16,929,004	18,515,544	9.4%	1,586,540
PROF	3,471,413	3,476,743	3,490,328	3,402,537	3,823,701	3,990,220	4.4%	166,519
UTIL	3,635,766	3,712,214	3,898,545	4,410,657	4,891,677	4,570,329	-6.6%	-321,348
MANU	1,407,679	1,421,516	1,518,346	2,165,467	3,404,227	3,058,016	-10.2%	-346,211
TRAN	782,392	558,386	441,635	571,958	1,047,145	741,481	-29.2%	-305,664
WHLS	1,923,639	2,235,271	2,209,742	2,263,975	2,178,318	2,276,794	4.5%	98,476
GOV	714,846	731,717	812,079	870,925	958,451	968,136	1.0%	9,685
TOTAL	176,979,392	190,627,772	200,056,184	211,219,695	227,284,783	241,773,296	6.4%	14,488,513

Table 6.13

For complete listing of Lines of Business, see page 13

Soldotna Annual TAXABLE Sales History	
2002	176,979,392
2003	190,627,772
2004	200,056,184
2005	211,219,695
2006	227,284,783
2007	241,773,296

Table 6.14

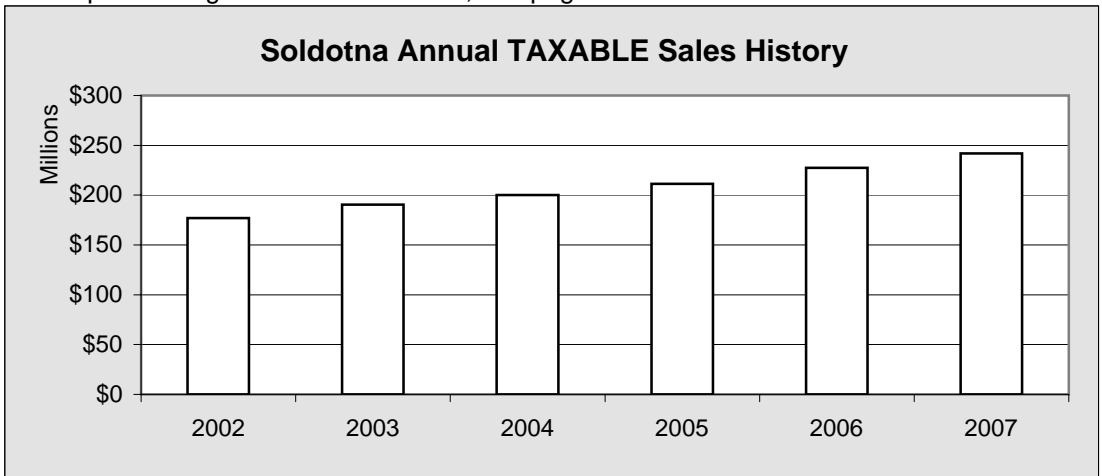

Chart 6.16

Five Year Change Annual TAXABLE Sales		
LOB	2002	2007
RSRC	47,017	47,330
SALES	122,443,869	173,396,532
CONST	1,035,905	1,051,570
PROP	7,006,887	7,759,987
TOUR	20,894,830	25,397,357
SERV	13,615,149	18,515,544
PROF	3,471,413	3,990,220
UTIL	3,635,766	4,570,329
MANU	1,407,679	3,058,016
TRAN	782,392	741,481
WHLS	1,923,639	2,276,794
GOV	714,846	968,136

Table 6.15

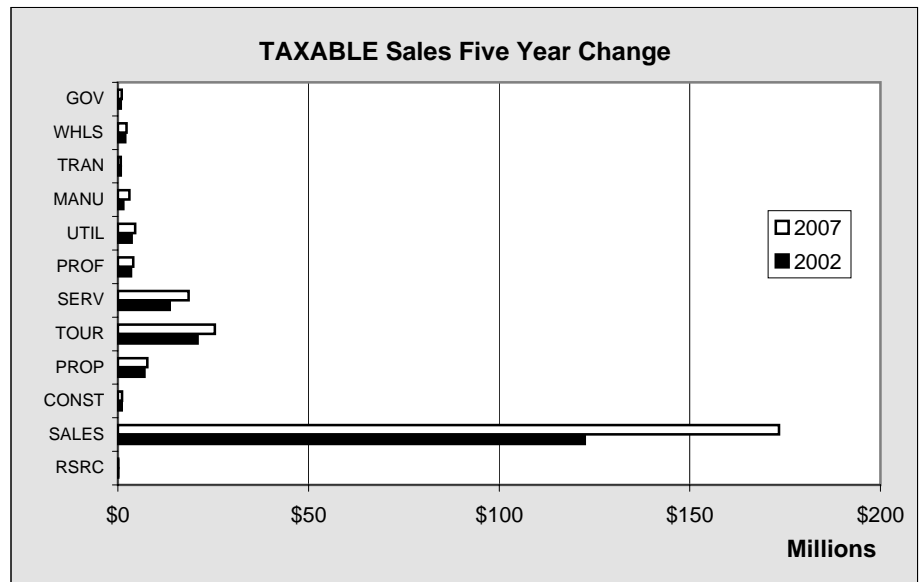

Chart 6.17

Soldotna Sales

Soldotna GROSS Sales by Line of Business by Quarter - 2007 - in \$

LOB	1st Quarter	2nd Quarter	3rd Quarter	4th Quarter	Total
Resource Production	216,327	503,137	171,052	45,081	935,597
Sales	45,529,056	59,333,738	79,396,932	60,383,242	244,642,968
Construction	7,265,067	8,748,496	8,565,596	12,218,031	36,797,190
Property	4,023,245	4,456,978	5,156,984	4,994,953	18,632,160
Tourism	4,985,288	7,321,117	10,300,044	4,655,921	27,262,370
Services	5,756,834	8,717,655	9,422,180	8,065,376	31,962,045
Professional	2,764,913	3,326,667	2,788,240	5,989,721	14,869,541
Utility	3,223,189	2,109,138	2,131,437	2,491,946	9,955,710
Manufacturing	1,813,100	2,893,476	4,334,146	2,569,265	11,609,987
Transportation & Warehousing	704,645	1,380,158	3,589,387	1,593,173	7,267,363
Wholesale	2,283,909	3,495,025	3,985,512	3,223,828	12,988,274
Government	269,132	340,977	271,583	265,837	1,147,529
TOTAL	78,834,705	102,626,562	130,113,093	106,496,374	418,070,734

Table 6.16

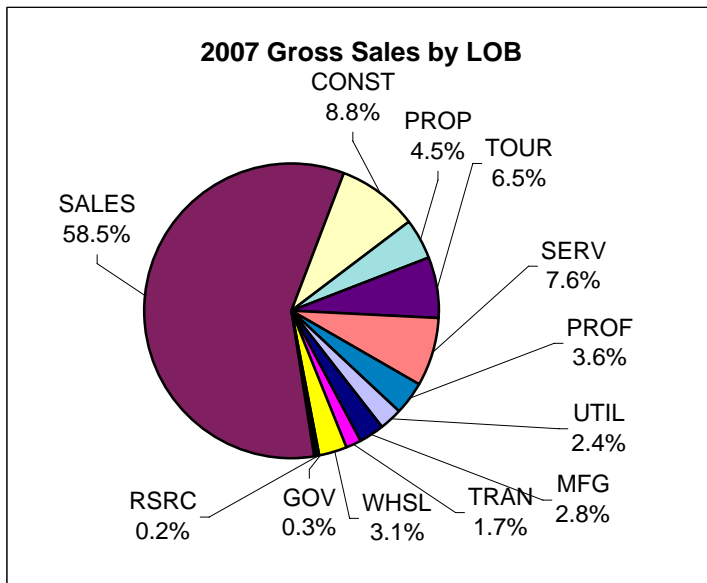

Chart 6.18

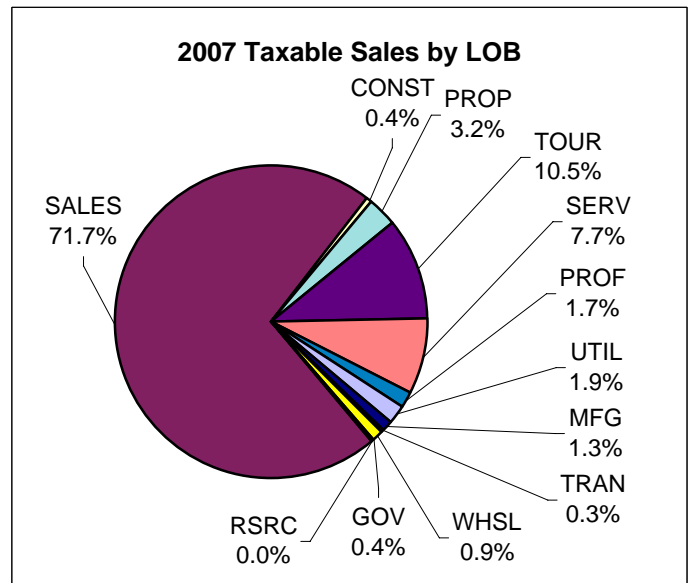

Chart 6.19

Soldotna TAXABLE Sales by Line of Business by Quarter - 2007 - in \$

LOB	1st Quarter	2nd Quarter	3rd Quarter	4th Quarter	Total
Resource Production	1,978	18,901	20,735	5,716	47,330
Sales	31,494,809	41,357,239	58,442,444	42,102,040	173,396,532
Construction	198,072	241,476	269,321	342,701	1,051,570
Property	1,545,677	1,878,682	2,117,703	2,217,925	7,759,987
Tourism	4,651,421	6,831,677	9,599,712	4,314,547	25,397,357
Services	3,892,766	5,008,239	4,990,058	4,624,481	18,515,544
Professional	1,011,042	1,145,425	985,163	848,590	3,990,220
Utility	1,483,163	1,022,444	931,473	1,133,249	4,570,329
Manufacturing	423,142	749,507	1,653,499	231,868	3,058,016
Transportation & Warehousing	49,678	187,974	451,956	51,873	741,481
Wholesale	478,776	459,955	517,761	820,302	2,276,794
Government	226,083	294,789	227,333	219,931	968,136
TOTAL	45,456,607	59,196,308	80,207,158	56,913,223	241,773,296

Table 6.17

Soldotna Sales

Soldotna GROSS Sales by Line of Business by Quarter - 2006 - in \$					
LOB	1st Quarter	2nd Quarter	3rd Quarter	4th Quarter	Total
Resource Production	9,508	33,737	46,180	147,104	236,529
Sales	42,044,629	55,804,681	74,436,017	55,775,283	228,060,610
Construction	6,085,004	12,052,501	9,164,421	46,179,935	73,481,861
Property	3,784,514	4,407,947	4,981,065	5,244,874	18,418,400
Tourism	4,924,092	7,489,297	10,370,571	5,450,351	28,234,311
Services	4,647,434	6,097,977	6,524,578	5,945,278	23,215,267
Professional	3,267,962	2,648,600	2,515,247	7,666,547	16,098,356
Utility	3,012,535	2,118,707	1,852,957	2,765,194	9,749,393
Manufacturing	1,452,464	2,477,219	4,186,336	2,750,085	10,866,104
Transportation & Warehousing	833,371	2,273,468	3,298,578	1,271,545	7,676,962
Wholesale	2,145,245	3,350,490	3,466,478	6,494,786	15,456,999
Government	250,285	268,747	337,436	262,805	1,119,273
TOTAL	72,457,043	99,023,371	121,179,864	139,953,787	432,614,065

Table 6.18

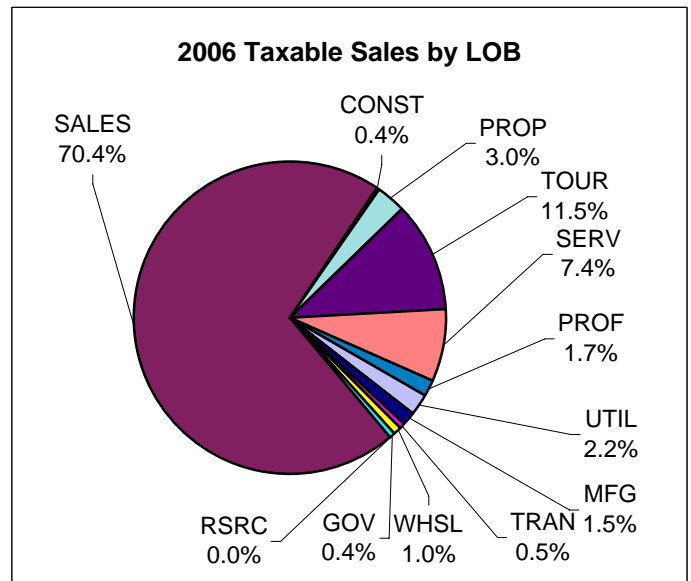
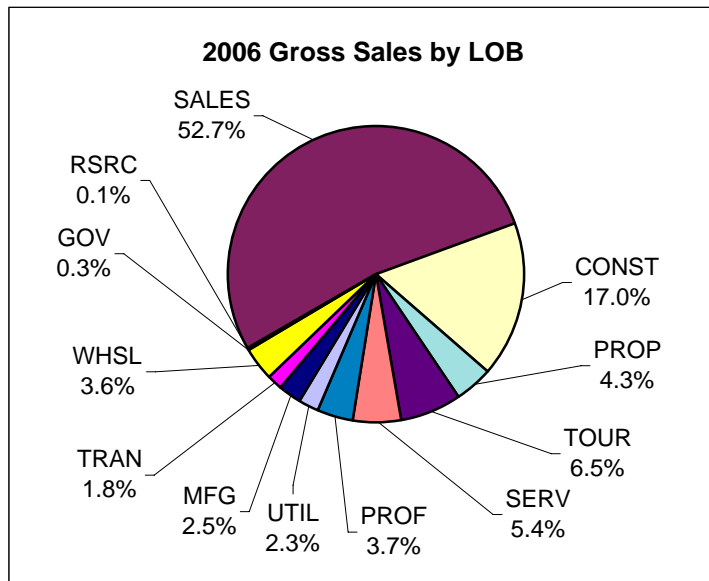

Chart 6.20

Chart 6.21

Soldotna TAXABLE Sales by Line of Business by Quarter - 2006 - in \$					
LOB	1st Quarter	2nd Quarter	3rd Quarter	4th Quarter	Total
Resource Production	1,990	14,023	17,770	6,847	40,630
Sales	28,164,098	38,268,488	54,591,419	39,077,825	160,101,830
Construction	209,651	253,076	228,897	247,023	938,647
Property	1,539,055	1,601,142	1,958,187	1,685,869	6,784,253
Tourism	4,624,082	7,029,007	9,422,474	5,111,337	26,186,900
Services	3,680,028	4,264,368	4,633,038	4,351,570	16,929,004
Professional	1,006,222	1,112,743	886,645	818,091	3,823,701
Utility	1,621,254	1,109,739	933,992	1,226,692	4,891,677
Manufacturing	527,827	714,499	1,519,774	642,127	3,404,227
Transportation & Warehousing	55,711	347,573	556,320	87,541	1,047,145
Wholesale	472,520	498,696	514,660	692,442	2,178,318
Government	215,019	231,090	286,966	225,376	958,451
TOTAL	42,117,457	55,444,444	75,550,142	54,172,740	227,284,783

Table 6.19

Soldotna Sales

Soldotna GROSS Sales by Line of Business by Quarter - 2005 - in \$					
LOB	1st Quarter	2nd Quarter	3rd Quarter	4th Quarter	Total
Resource Production	63,986	160,747	198,235	16,081	439,049
Sales	40,701,206	55,923,754	71,288,068	49,821,411	217,734,439
Construction	4,375,551	4,117,881	8,669,201	43,423,707	60,586,340
Property	3,412,007	4,109,952	4,335,361	3,760,500	15,617,820
Tourism	4,510,107	6,813,740	9,972,699	5,258,468	26,555,014
Services	4,195,661	5,120,763	5,091,858	4,913,564	19,321,846
Professional	2,228,478	2,290,228	2,504,323	7,694,574	14,717,603
Utility	2,549,610	1,861,397	1,740,395	2,296,442	8,447,844
Manufacturing	1,084,741	2,242,896	3,752,235	2,996,668	10,076,540
Transporation & Warehousing	736,885	1,768,221	2,591,957	1,414,152	6,511,215
Wholesale	1,878,246	2,993,234	3,489,513	6,667,238	15,028,231
Government	219,667	237,176	312,441	236,866	1,006,150
TOTAL	65,956,145	87,639,989	113,946,286	128,499,671	396,042,091

Table 6.20

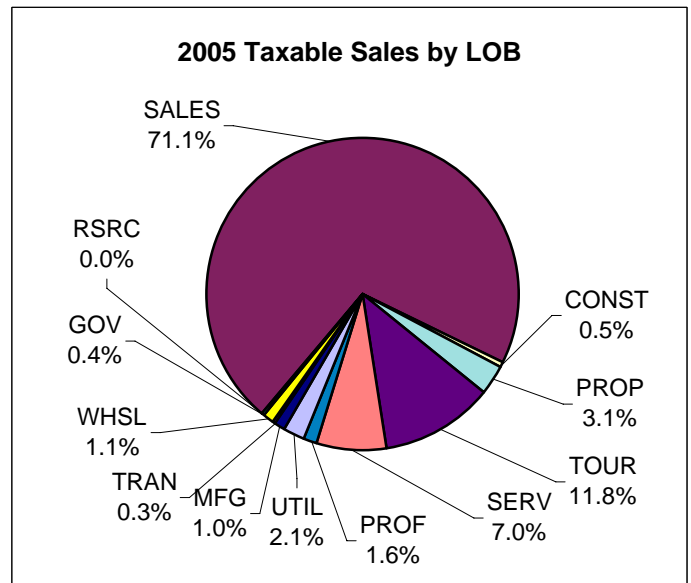
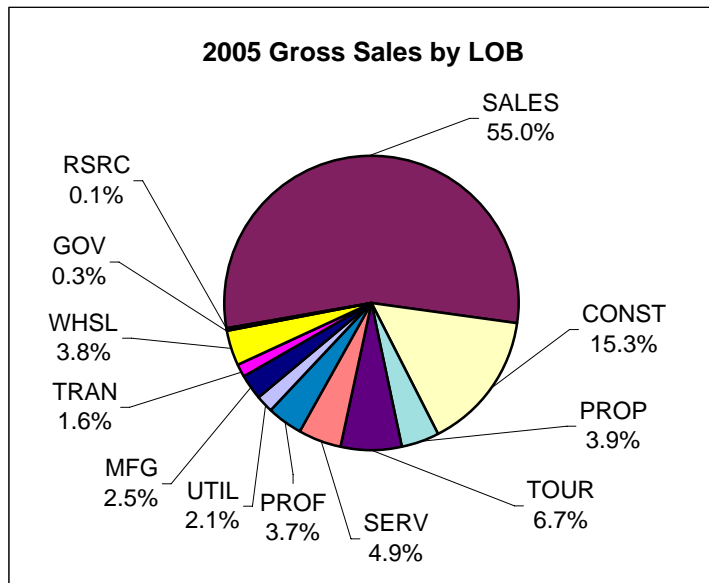

Chart 6.22

Chart 6.23

Soldotna TAXABLE Sales by Line of Business by Quarter - 2005 - in \$					
LOB	1st Quarter	2nd Quarter	3rd Quarter	4th Quarter	Total
Resource Production	1,445	7,109	15,368	5,653	29,575
Sales	26,529,757	36,912,626	50,787,602	35,997,976	150,227,961
Construction	250,780	249,699	254,859	243,720	999,058
Property	1,454,800	1,618,112	1,794,813	1,676,421	6,544,146
Tourism	4,203,922	6,410,759	9,340,550	4,994,629	24,949,860
Services	3,256,805	3,872,567	3,964,122	3,690,082	14,783,576
Professional	902,696	911,827	881,284	706,730	3,402,537
Utility	1,341,878	979,377	858,071	1,231,331	4,410,657
Manufacturing	56,295	282,123	1,003,233	823,816	2,165,467
Transporation & Warehousing	48,473	161,304	270,952	91,229	571,958
Wholesale	474,798	534,128	520,225	734,824	2,263,975
Government	193,023	205,613	265,224	207,065	870,925
TOTAL	38,714,672	52,145,244	69,956,303	50,403,476	211,219,695

Table 6.21

Soldotna Construction Permits

Soldotna 4th Quarter Permit VALUES by Type - 2001-2007 - in \$								
	2001	2002	2003	2004	2005	2006	2007	Annual Change
Residential New	0	176,000	526,191	294,860	165,123	172,833	88,000	-49.1%
Residential Alter/Add	51,148	11,500	5,000	57,454	2,000	262,659	248,665	-5.3%
Commercial New	0	0	281,491	501,601	0	0	1,654,112	NA
Commercial Alter/Add	111,500	70,000	60,363	3,850,000	2,717	197,390	301,268	52.6%
Total	162,648	257,500	873,045	4,703,915	169,840	632,882	2,292,045	262.2%
Annual Change		58.3%	239.0%	438.8%	-96.4%	272.6%	262.2%	

Table 6.22

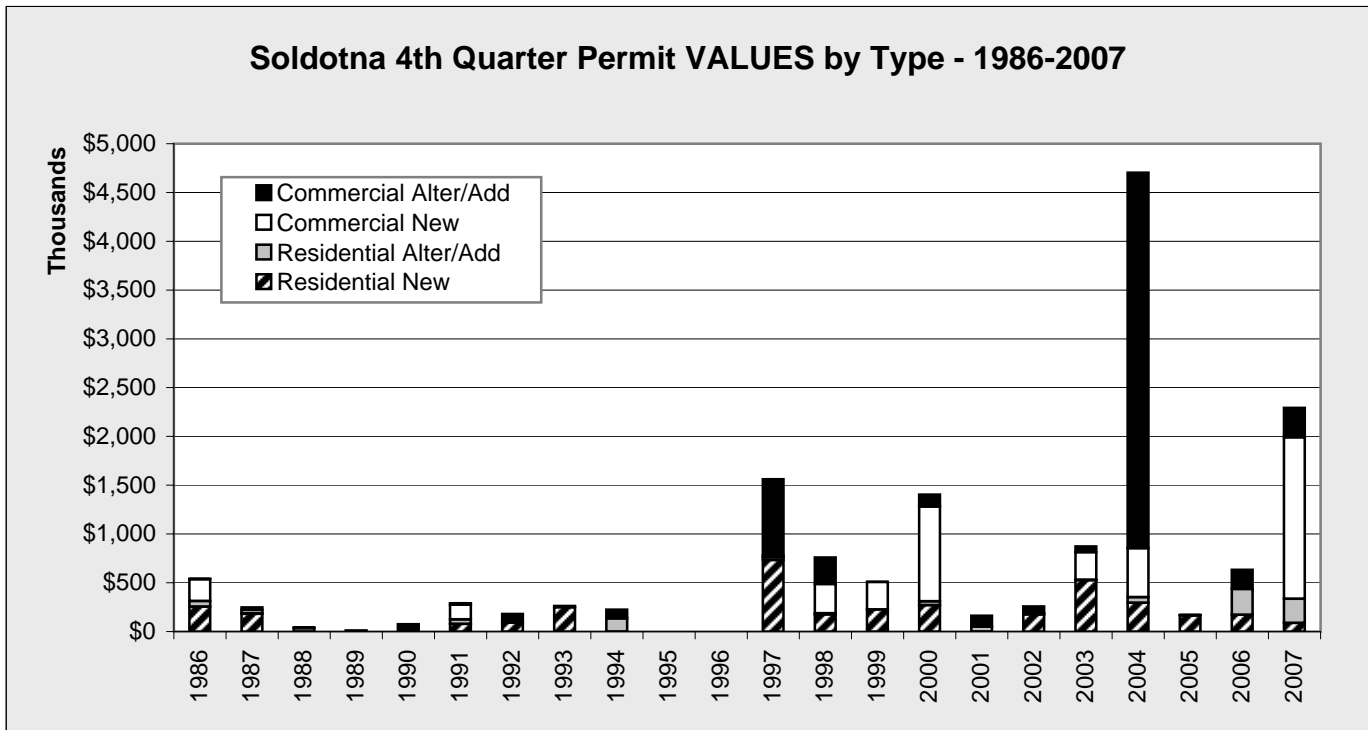

Chart 6.24

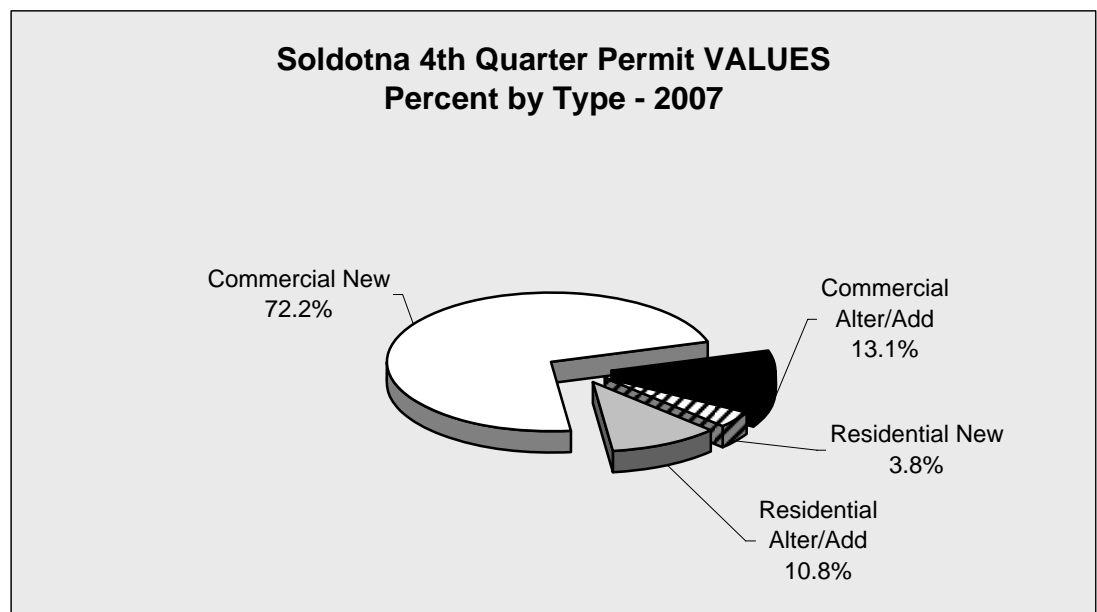

Chart 6.25

Soldotna Construction Permits

Soldotna 4th Quarter Permit VOLUME by Type - 2001-2007								
	2001	2002	2003	2004	2005	2006	2007	Annual Change
Residential New	0	1	5	1	1	1	2	100.0%
Residential Alter/Add	4	2	1	3	1	3	6	100.0%
Commercial New	0	0	2	2	0	0	4	NA
Commercial Alter/Add	7	1	5	2	3	3	4	33.3%
Total	11	4	13	8	5	7	16	128.6%
Annual Change		-63.6%	225.0%	-38.5%	-37.5%	40.0%	128.6%	

Table 6.23

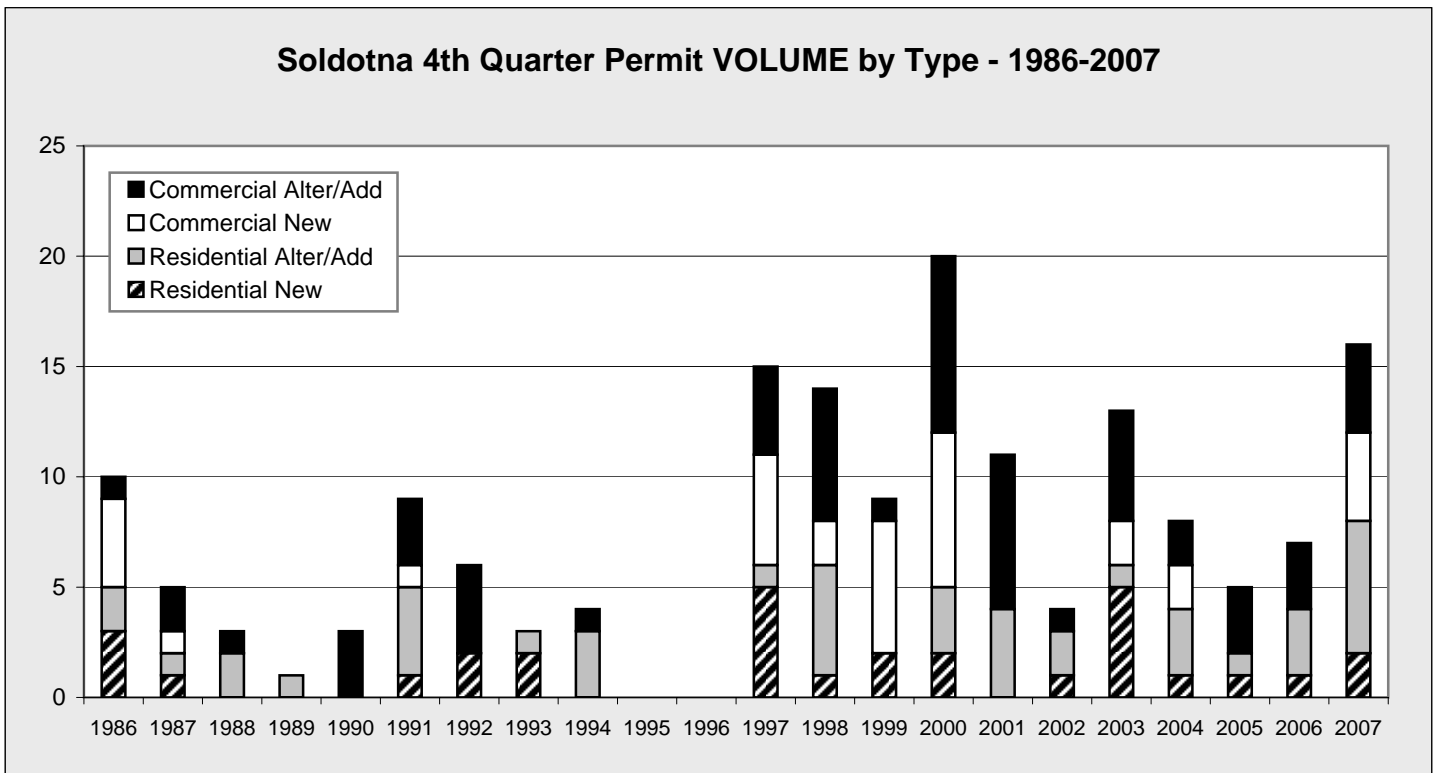

Chart 6.26

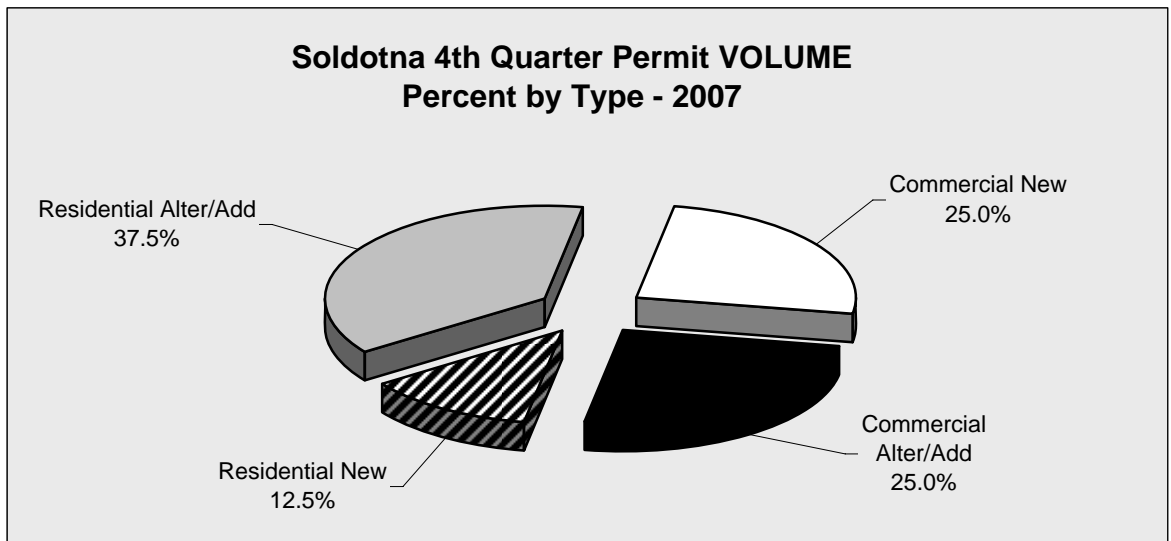

Chart 6.27

Soldotna Construction Permits

Soldotna Annual Permit VALUES by Type - 2001-2007 - in \$								
	2001	2002	2003	2004	2005	2006	2007	Annual Change
Residential New	3,873,853	3,181,344	3,073,933	3,881,344	4,098,748	7,599,440	8,749,413	15.1%
Residential Alter/Add	357,495	755,187	263,629	277,984	493,990	782,177	733,440	-6.2%
Commercial New	3,288,822	4,397,059	3,769,181	28,329,025	5,814,828	12,924,852	3,661,554	-71.7%
Commercial Alter/Add	1,434,802	2,830,304	845,554	4,808,573	1,101,794	1,887,931	618,516	-67.2%
Total	8,954,972	11,163,894	7,952,297	37,296,926	11,509,360	23,194,400	13,762,923	-40.7%
Annual Change		24.7%	-28.8%	369.0%	-69.1%	101.5%	-40.7%	

Table 6.24

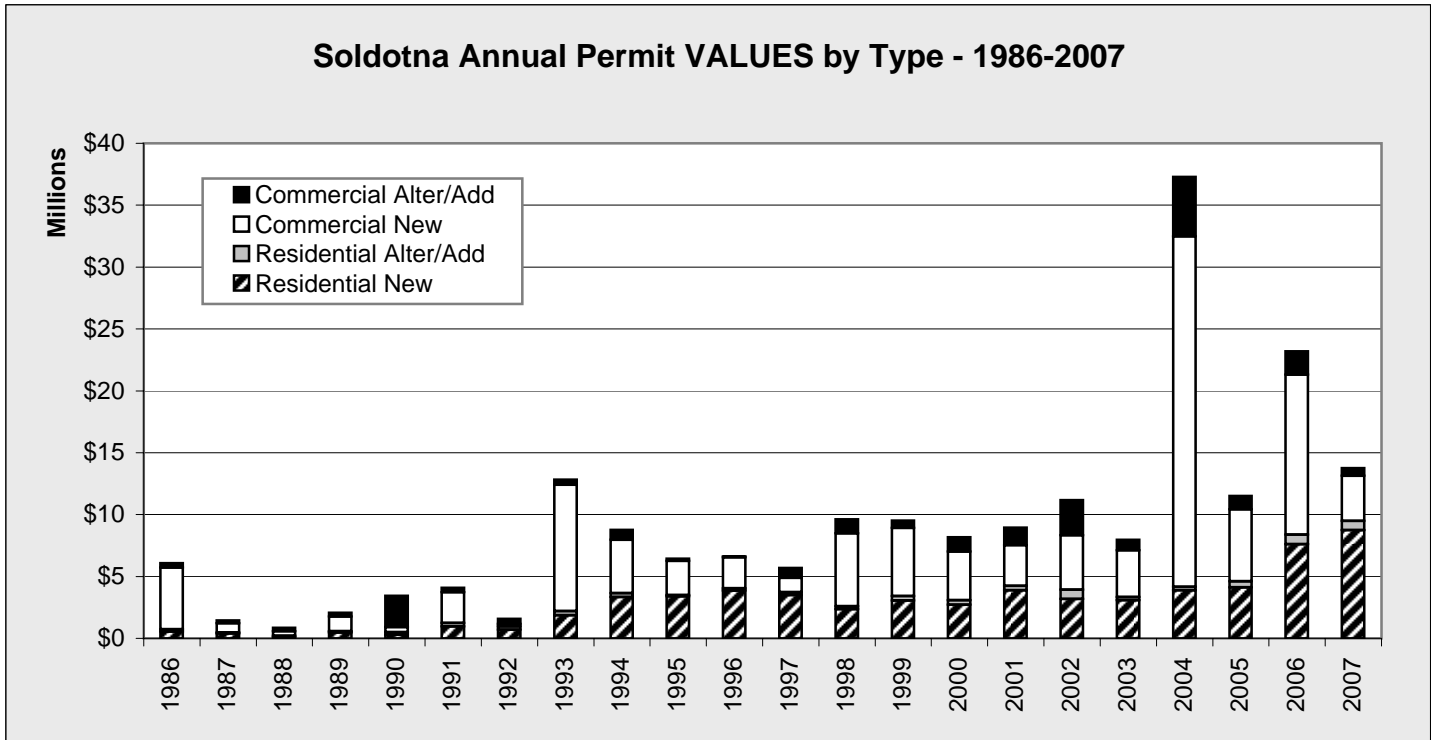

Chart 6.28

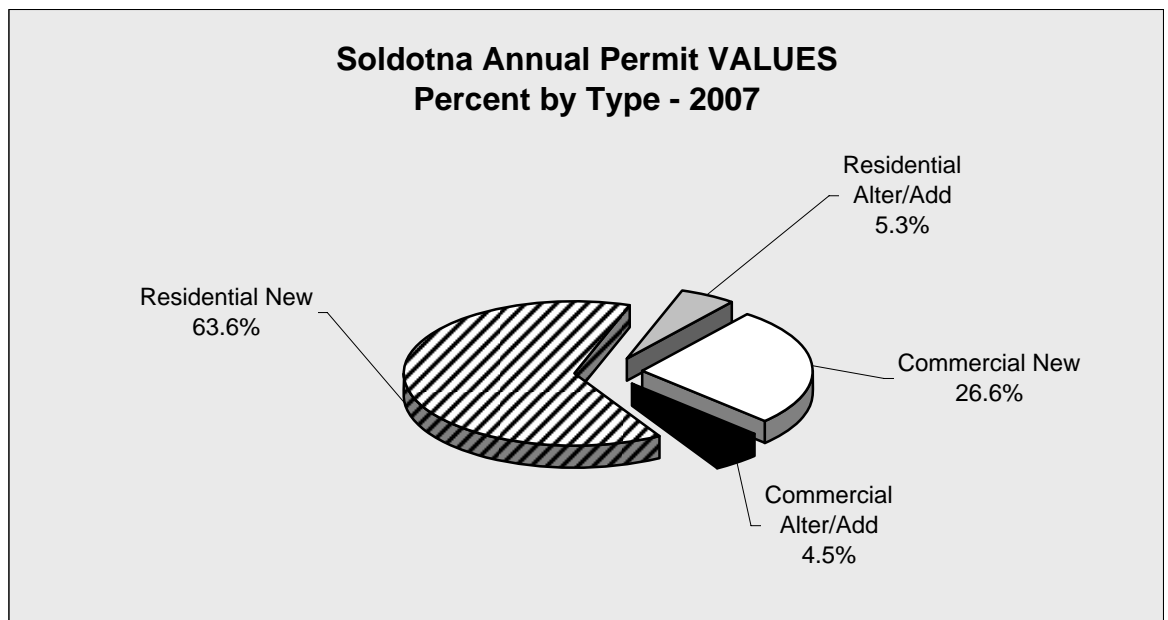

Chart 6.29

Soldotna Construction Permits

Soldotna Annual Permit VOLUME by Type - 2001-2007

	2001	2002	2003	2004	2005	2006	2007	Annual Change
Residential New	24	24	24	19	23	29	30	3.4%
Residential Alter/Add	23	20	16	17	23	15	18	20.0%
Commercial New	10	18	16	13	13	9	11	22.2%
Commercial Alter/Add	36	29	18	18	22	11	21	90.9%
Total	93	91	74	67	81	64	80	25.0%
Annual Change		-2.2%	-18.7%	-9.5%	20.9%	-21.0%	25.0%	

Table 6.25

Soldotna Annual Permit VOLUME by Type - 1986-2007

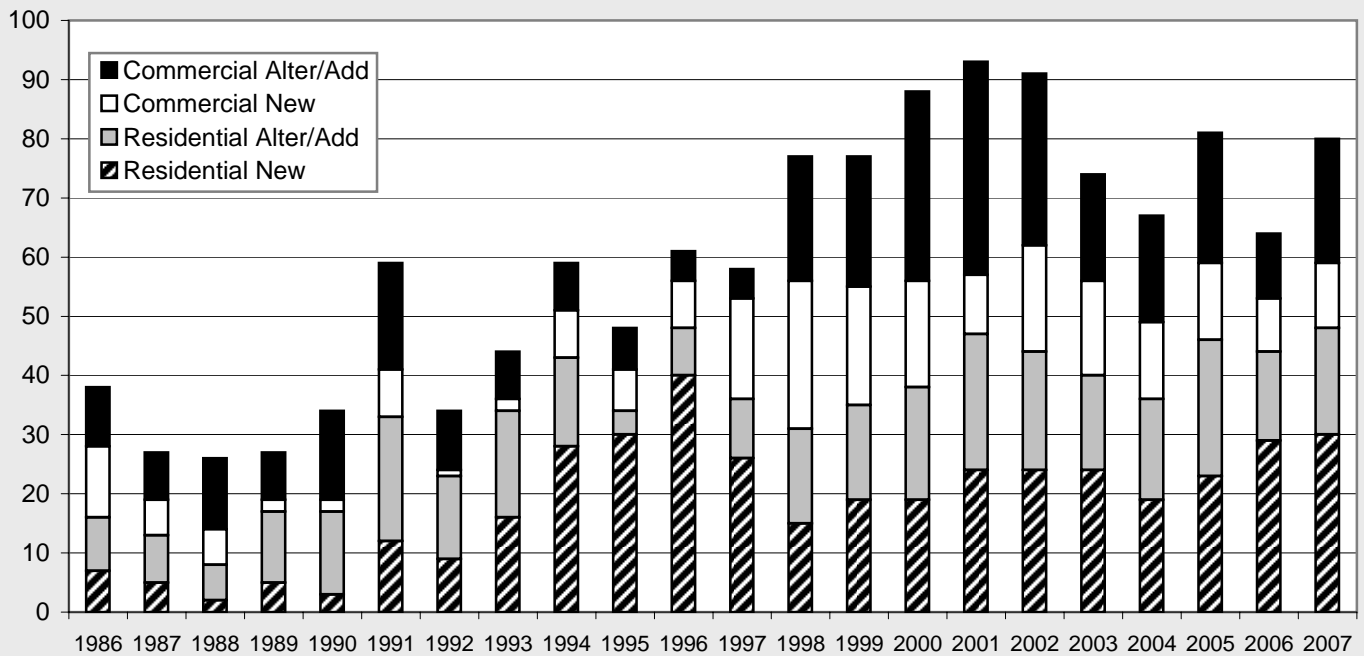

Chart 6.30

**Soldotna Annual Permit VOLUME
Percent by Type - 2007**

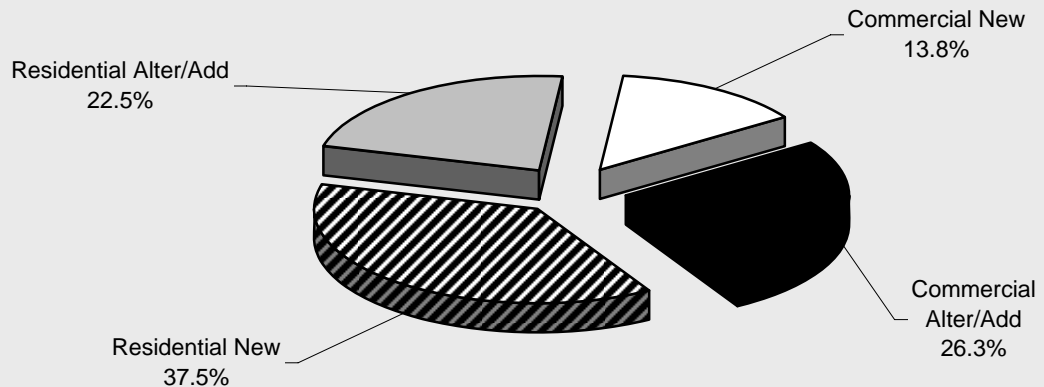

Chart 6.31

Soldotna Construction Permits

Soldotna Annual Permit VALUE by Type by Quarter - 2000-2007 - in \$					
	1st Quarter	2nd Quarter	3rd Quarter	4th Quarter	Total
2000					
Residential - New	373,929	1,520,491	543,930	270,668	2,709,018
Residential - Add/Alter	0	224,674	101,065	39,500	365,239
Commercial - New	434,273	1,583,642	935,665	970,484	3,924,064
Commercial - Add/Alter	270,000	680,549	96,250	122,300	1,169,099
TOTAL	1,078,202	4,009,356	1,676,910	1,402,952	8,167,420
2001					
Residential - New	0	2,363,001	1,510,852	0	3,873,853
Residential - Add/Alter	105,160	151,039	50,148	51,148	357,495
Commercial - New	2,658,578	0	630,244	0	3,288,822
Commercial - Add/Alter	287,480	717,150	318,672	111,500	1,434,802
TOTAL	3,051,218	3,231,190	2,509,916	162,648	8,954,972
2002					
Residential - New	240,849	2,075,293	689,202	176,000	3,181,344
Residential - Add/Alter	86,935	339,286	317,466	11,500	755,187
Commercial - New	714,806	2,601,575	1,080,678	0	4,397,059
Commercial - Add/Alter	163,000	1,987,304	610,000	70,000	2,830,304
TOTAL	1,205,590	7,003,458	2,697,346	257,500	11,163,894
2003					
Residential - New	0	1,899,354	648,388	526,191	3,073,933
Residential - Add/Alter	57,827	130,080	70,722	5,000	263,629
Commercial - New	0	2,116,490	1,371,200	281,491	3,769,181
Commercial - Add/Alter	369,191	88,000	328,000	60,363	845,554
TOTAL	427,018	4,233,924	2,418,310	873,045	7,952,297
2004					
Residential - New	539,297	1,777,087	1,270,100	294,860	3,881,344
Residential - Add/Alter	0	74,809	145,721	57,454	277,984
Commercial - New	4,465,026	1,366,297	21,996,101	501,601	28,329,025
Commercial - Add/Alter	60,000	530,380	368,193	3,850,000	4,808,573
TOTAL	5,064,323	3,748,573	23,780,115	4,703,915	37,296,926
2005					
Residential - New	720,956	1,916,999	1,295,670	165,123	4,098,748
Residential - Add/Alter	261,630	141,950	88,410	2,000	493,990
Commercial - New	195,000	4,099,828	1,520,000	0	5,814,828
Commercial - Add/Alter	243,969	673,458	181,650	2,717	1,101,794
TOTAL	1,421,555	6,832,235	3,085,730	169,840	11,509,360
2006					
Residential - New	204,031	2,116,499	5,106,077	172,833	7,599,440
Residential - Add/Alter	10,000	140,730	368,788	262,659	782,177
Commercial - New	312,410	4,965,648	7,646,794	0	12,924,852
Commercial - Add/Alter	1,590,000	8,451	92,090	197,390	1,887,931
TOTAL	2,116,441	7,231,328	13,213,749	632,882	23,194,400
2007					
Residential - New	535,722	6,083,538	2,042,153	88,000	8,749,413
Residential - Add/Alter	149,549	224,588	110,638	248,665	733,440
Commercial - New	0	1,461,142	546,300	1,654,112	3,661,554
Commercial - Add/Alter	142,500	107,937	66,811	301,268	618,516
TOTAL	827,771	7,877,205	2,765,902	2,292,045	13,762,923

Table 6.26

Soldotna Construction Permits

Soldotna Annual Permit VOLUME by Type by Quarter - 2000-2007					
	1st Quarter	2nd Quarter	3rd Quarter	4th Quarter	Total
2000					
Residential - New	2	10	5	2	19
Residential - Add/Alter	0	9	7	3	19
Commercial - New	1	3	7	7	18
Commercial - Add/Alter	5	12	7	8	32
TOTAL	8	34	26	20	88
2001					
Residential - New	0	14	10	0	24
Residential - Add/Alter	3	10	6	4	23
Commercial - New	3	0	7	0	10
Commercial - Add/Alter	4	13	12	7	36
TOTAL	10	37	35	11	93
2002					
Residential - New	1	17	5	1	24
Residential - Add/Alter	2	6	10	2	20
Commercial - New	4	9	5	0	18
Commercial - Add/Alter	4	19	5	1	29
TOTAL	11	51	25	4	91
2003					
Residential - New	0	15	4	5	24
Residential - Add/Alter	3	8	4	1	16
Commercial - New	0	6	8	2	16
Commercial - Add/Alter	3	7	3	5	18
TOTAL	6	36	19	13	74
2004					
Residential - New	2	9	7	1	19
Residential - Add/Alter	0	8	6	3	17
Commercial - New	4	3	4	2	13
Commercial - Add/Alter	3	6	7	2	18
TOTAL	9	26	24	8	67
2005					
Residential - New	4	11	7	1	23
Residential - Add/Alter	3	12	7	1	23
Commercial - New	2	9	2	0	13
Commercial - Add/Alter	7	8	4	3	22
TOTAL	16	40	20	5	81
2006					
Residential - New	1	13	14	1	29
Residential - Add/Alter	1	6	5	3	15
Commercial - New	1	5	3	0	9
Commercial - Add/Alter	2	1	5	3	11
TOTAL	5	25	27	7	64
2007					
Residential - New	2	16	10	2	30
Residential - Add/Alter	2	5	5	6	18
Commercial - New	0	5	2	4	11
Commercial - Add/Alter	5	7	5	4	21
TOTAL	9	33	22	16	80

Table 6.27

Other KPB Sales

Other KPB Annual Gross Sales by Quarter - in \$

	1st Quarter	2nd Quarter	3rd Quarter	4th Quarter	Total	Annual Change
1991	150,310,802	179,981,395	203,939,374	149,376,132	683,607,703	
1992	127,619,172	131,303,143	212,891,465	156,078,723	627,892,503	-8.2%
1993	121,510,145	154,604,317	196,780,937	151,589,385	624,484,784	-0.5%
1994	108,045,292	168,026,112	227,742,774	160,338,704	664,152,882	6.4%
1995	129,319,512	176,944,646	233,045,872	155,296,678	694,606,708	4.6%
1996	118,798,405	164,583,791	200,339,231	146,554,575	630,276,002	-9.3%
1997	121,205,814	175,801,297	252,318,601	180,020,471	729,346,183	15.7%
1998	153,607,622	211,191,964	235,128,992	193,091,815	793,020,393	8.7%
1999	137,446,972	180,709,546	232,722,008	182,269,903	733,148,429	-7.5%
2000	126,664,981	183,977,517	225,474,396	172,187,791	708,304,685	-3.4%
2001	170,550,210	217,647,967	286,402,452	290,090,088	964,690,717	36.2%
2002	159,548,666	216,025,032	262,921,008	224,634,715	863,129,421	-10.5%
2003	154,468,221	208,425,856	284,006,188	215,378,295	862,278,560	-0.1%
2004	159,172,351	187,501,467	326,705,298	425,427,000	1,098,806,116	27.4%
2005	183,044,920	241,586,220	326,172,877	445,506,147	1,196,310,164	8.9%
2006	172,546,475	261,512,403	336,081,843	479,884,456	1,250,025,177	4.5%
2007	199,832,419	254,923,124	339,265,190	487,471,117	1,281,491,850	2.5%
Change	15.8%	-2.5%	0.9%	1.6%	2.5%	

Table 7.1

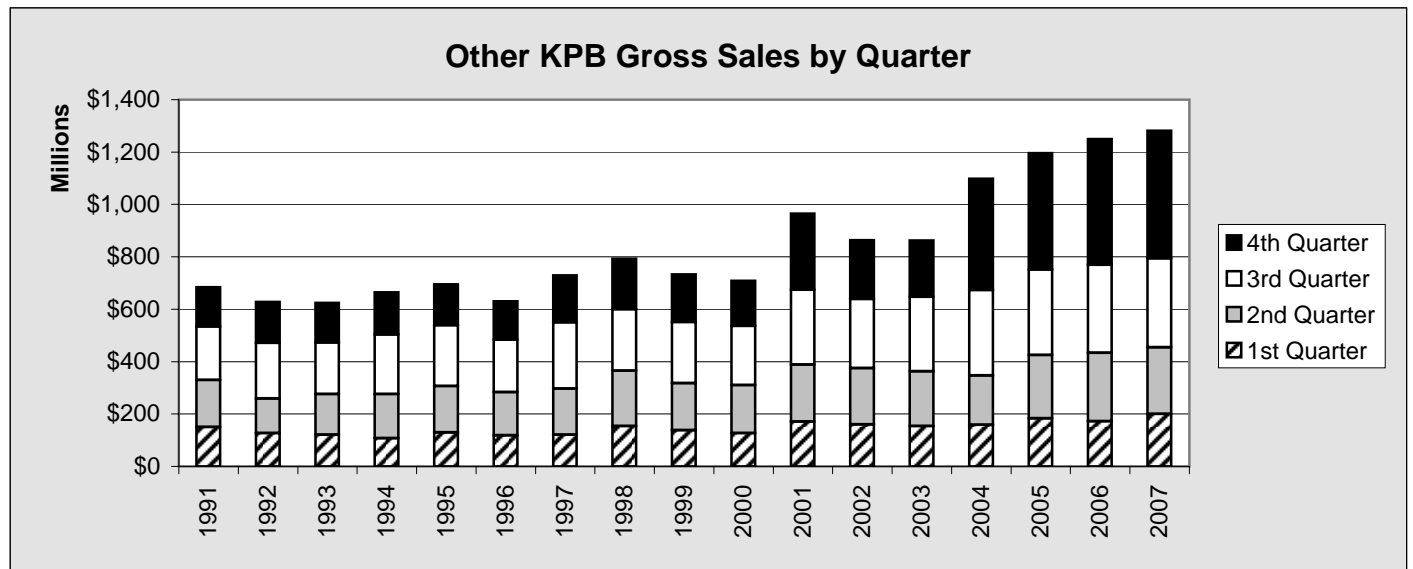

Chart 7.1

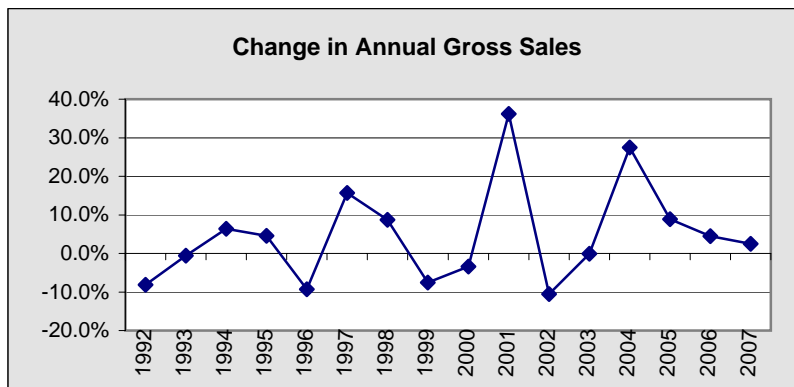

Chart 7.2

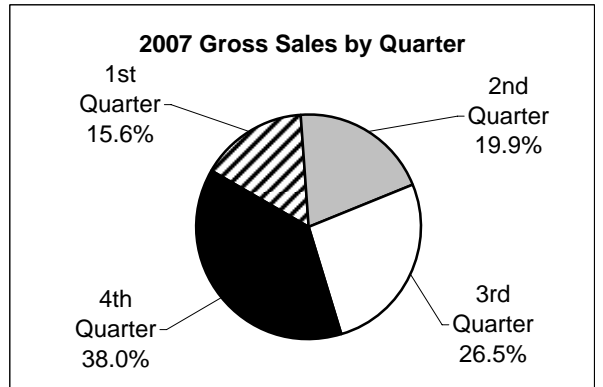

Chart 7.3

Other KPB Sales

Other KPB Annual Taxable Sales by Quarter - in \$

	1st Quarter	2nd Quarter	3rd Quarter	4th Quarter	Total	Annual Change
1991	27,141,907	37,090,247	41,764,755	29,785,624	135,782,533	
1992	26,681,025	37,431,014	45,075,097	31,035,390	140,222,526	3.3%
1993	27,948,955	39,890,147	45,991,097	32,780,220	146,610,419	4.6%
1994	28,736,078	41,443,906	48,711,068	33,683,616	152,574,668	4.1%
1995	29,644,424	44,648,194	52,795,407	35,781,690	162,869,715	6.7%
1996	30,783,420	44,988,294	53,390,165	35,276,802	164,438,681	1.0%
1997	31,351,194	47,363,481	56,193,073	37,525,660	172,433,408	4.9%
1998	33,492,756	49,242,778	58,040,464	38,773,336	179,549,334	4.1%
1999	34,348,468	50,746,526	61,313,334	40,985,751	187,394,079	4.4%
2000	35,696,361	55,205,057	66,472,925	41,967,937	199,342,280	6.4%
2001	38,055,259	57,871,082	68,871,018	46,773,634	211,570,993	6.1%
2002	41,860,984	57,515,479	69,125,012	42,247,807	210,749,282	-0.4%
2003	38,386,873	58,301,294	69,993,550	43,041,546	209,723,263	-0.5%
2004	39,077,453	58,428,144	75,635,945	45,404,681	218,546,223	4.2%
2005	41,133,862	63,261,747	79,539,712	48,701,794	232,637,115	6.4%
2006	45,961,614	68,338,881	87,254,996	54,964,648	256,520,139	10.3%
2007	52,815,187	77,017,758	101,687,281	56,704,945	288,225,171	12.4%
Change	14.9%	12.7%	16.5%	3.17%	12.4%	

Table 7.2

Other KPB Taxable Sales by Quarter

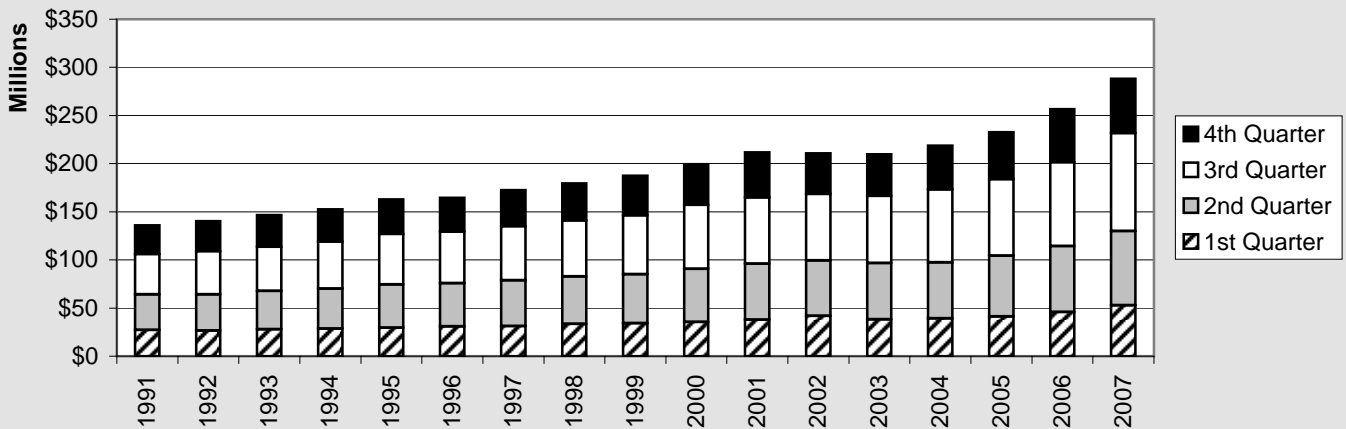

Chart 7.4

Change in Annual Taxable Sales

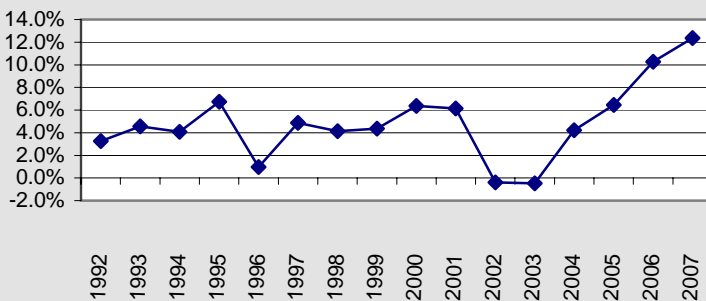

Chart 7.5

2007 Taxable Sales by Quarter

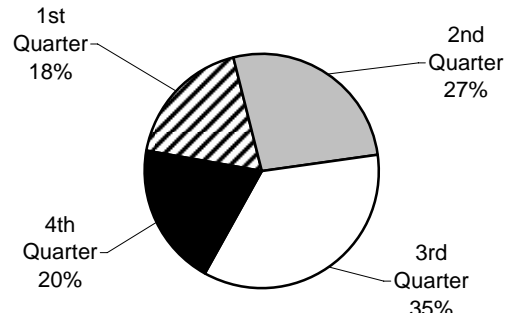

Chart 7.6

Other KPB Sales

Other KPB Annual Nontaxable Sales by Quarter - in \$						
	1st Quarter	2nd Quarter	3rd Quarter	4th Quarter	Total	Annual Change
1991	123,168,895	142,891,148	162,174,619	119,590,508	547,825,170	
1992	100,938,147	93,872,129	167,816,368	125,043,333	487,669,977	-11.0%
1993	93,561,190	114,714,170	150,789,840	118,809,165	477,874,365	-2.0%
1994	79,309,214	126,582,206	179,031,706	126,655,088	511,578,214	7.1%
1995	99,675,088	132,296,452	180,250,465	119,514,988	531,736,993	3.9%
1996	88,014,985	119,595,497	146,949,066	111,277,773	465,837,321	-12.4%
1997	89,854,620	128,437,816	196,125,528	142,494,811	556,912,775	19.6%
1998	120,114,866	161,949,186	177,088,528	154,318,479	613,471,059	10.2%
1999	103,098,504	129,963,020	171,408,674	141,284,152	545,754,350	-11.0%
2000	90,968,620	128,772,460	159,001,471	130,219,854	508,962,405	-6.7%
2001	132,494,951	159,776,885	217,531,434	243,316,454	753,119,724	48.0%
2002	117,687,682	158,509,553	193,795,996	182,386,908	652,380,139	-13.4%
2003	116,081,348	150,124,562	214,012,638	172,336,749	652,555,297	0.0%
2004	120,094,898	129,073,323	251,069,353	380,022,319	880,259,893	34.9%
2005	141,911,058	178,324,473	246,633,165	396,804,353	963,673,049	9.5%
2006	126,584,861	193,173,522	248,826,847	424,919,808	993,505,038	3.1%
2007	147,017,232	177,905,366	237,577,909	430,766,172	993,266,679	0.0%
Change	16.1%	-7.9%	-4.5%	1.4%	0.0%	

Table 7.3

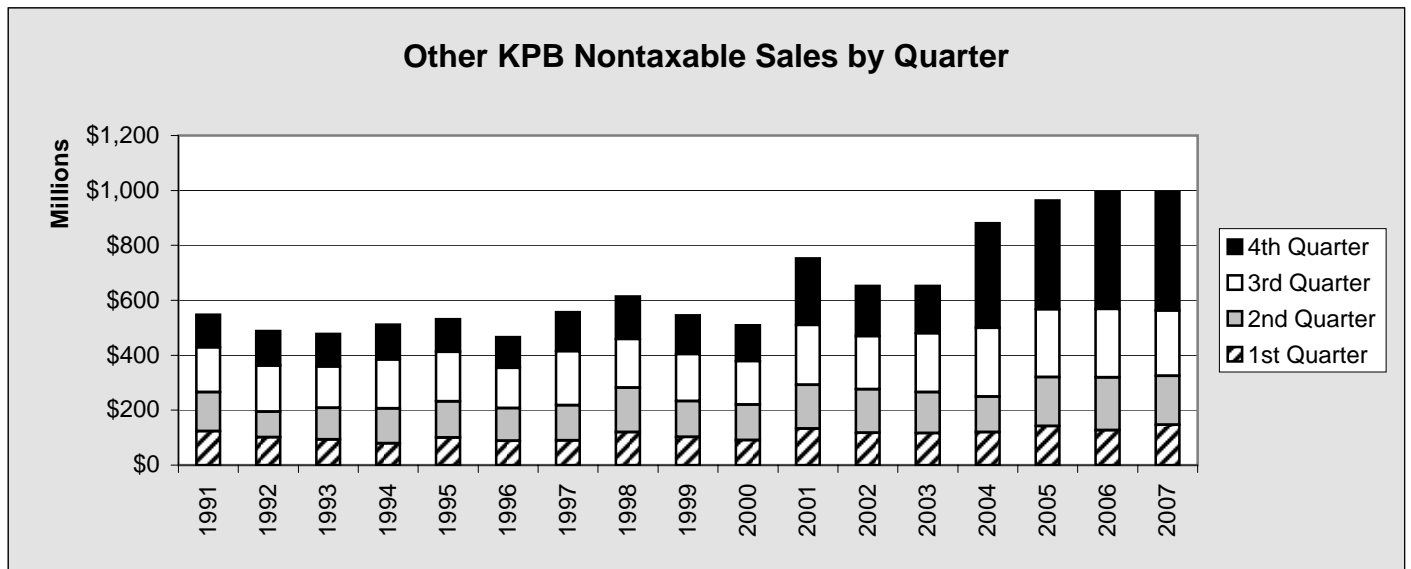

Chart 7.7

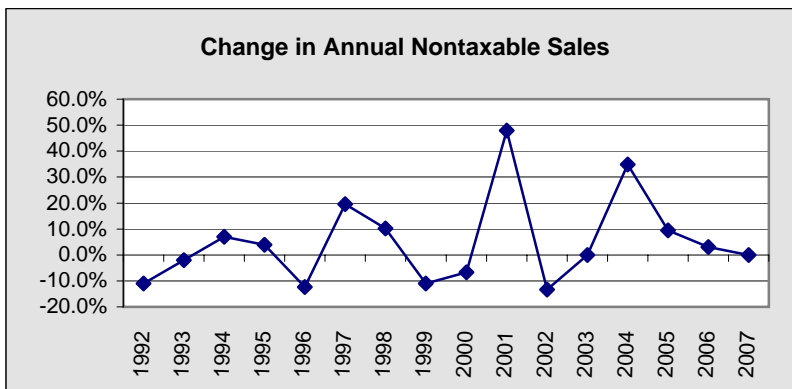

Chart 7.8

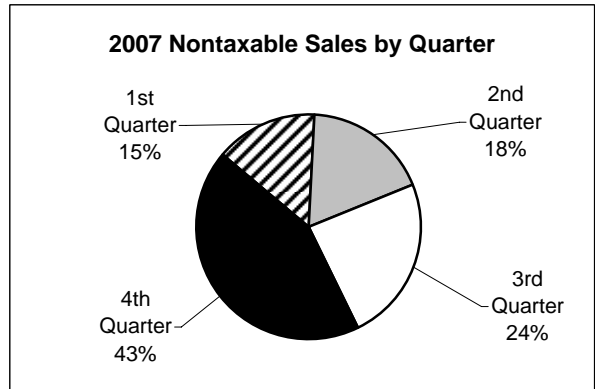

Chart 7.9

Other KPB Sales

Other KPB 4th Quarter GROSS Sales by Line of Business - 2002-2007 - in \$								
LOB	2002	2003	2004	2005	2006	2007	Annual Percent Change	Annual Amount Change
RSRC	82,450,791	55,326,593	51,616,198	47,921,326	33,402,560	39,794,157	19.1%	6,391,597
SALES	49,095,018	31,679,072	32,295,144	32,107,182	36,082,840	38,055,835	5.5%	1,972,995
CONST	31,729,639	28,472,536	52,412,101	44,547,265	62,016,420	30,532,633	-50.8%	-31,483,787
PROP	5,222,206	6,433,817	7,349,957	7,433,786	7,140,062	6,978,156	-2.3%	-161,906
TOUR	4,448,840	4,189,853	4,292,636	4,449,580	5,061,243	4,455,156	-12.0%	-606,087
SERV	9,994,023	10,709,535	24,253,060	17,630,767	18,748,174	20,423,028	8.9%	1,674,854
PROF	3,808,987	3,786,209	4,782,297	5,117,063	6,654,658	5,216,295	-21.6%	-1,438,363
UTIL	9,160,116	8,795,544	9,695,190	11,658,194	15,756,787	15,348,481	-2.6%	-408,306
MANU	9,840,660	25,070,722	25,709,847	31,199,145	21,991,975	26,400,834	20.0%	4,408,859
TRAN	3,255,578	4,898,372	8,973,762	10,037,666	9,795,698	7,091,439	-27.6%	-2,704,259
WHLS	15,268,030	35,184,438	202,996,265	232,922,691	262,901,536	293,081,852	11.5%	30,180,316
GOV	360,827	831,604	1,050,543	481,482	332,503	93,251	-72.0%	-239,252
TOTAL	224,634,715	215,378,295	425,427,000	445,506,147	479,884,456	487,471,117	1.6%	7,586,661

Table 7.4

For complete listing of Lines of Business, see page 13

Other KPB 4th Quarter GROSS Sales History	
2002	224,634,715
2003	215,378,295
2004	425,427,000
2005	445,506,147
2006	479,884,456
2007	487,471,117

Table 7.5

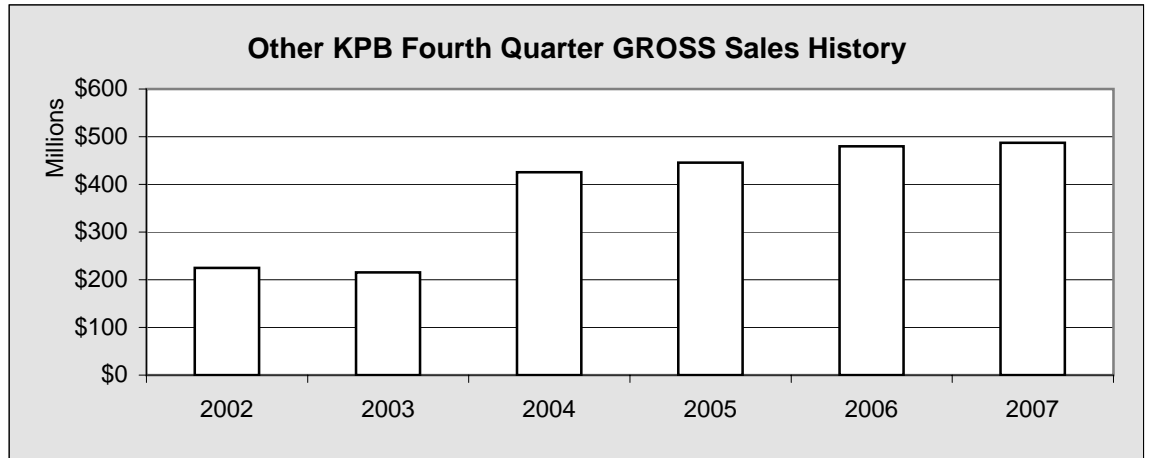

Chart 7.10

Other KPB Five Year Change 4th Quarter GROSS Sales		
LOB	2002	2007
RSRC	82,450,791	39,794,157
SALES	49,095,018	38,055,835
CONST	31,729,639	30,532,633
PROP	5,222,206	6,978,156
TOUR	4,448,840	4,455,156
SERV	9,994,023	20,423,028
PROF	3,808,987	5,216,295
UTIL	9,160,116	15,348,481
MANU	9,840,660	26,400,834
TRAN	3,255,578	7,091,439
WHLS	15,268,030	293,081,852
GOV	360,827	93,251

Table 7.6

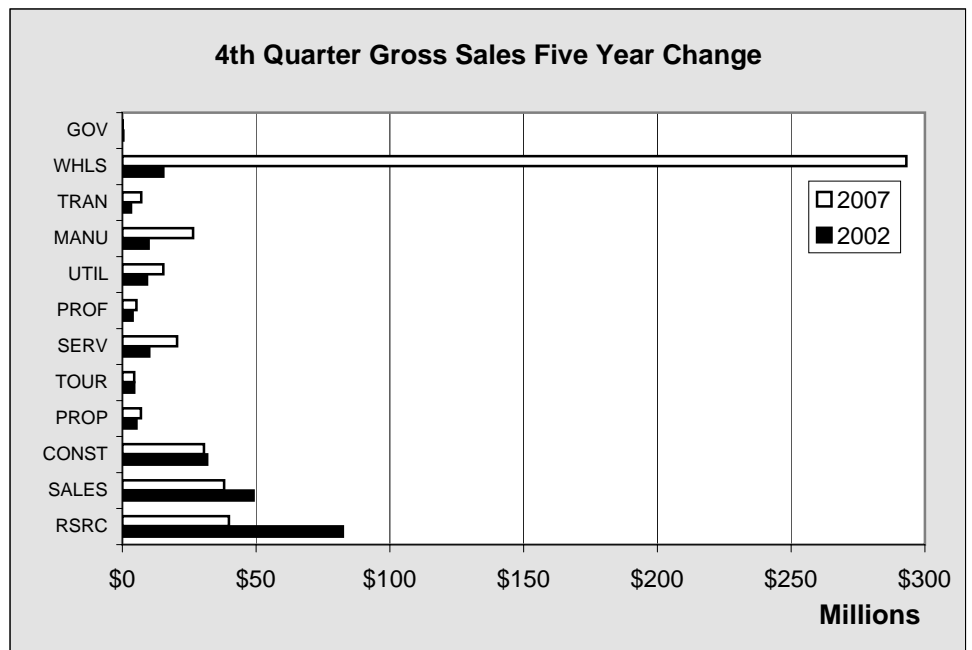

Chart 7.11

Other KPB Sales

Other KPB 4th Quarter TAXABLE Sales by Line of Business - 2002-2007 - in \$								
LOB	2002	2003	2004	2005	2006	2007	Annual Percent Change	Annual Amount Change
RSRC	1,280,417	1,013,444	1,211,698	1,030,021	1,088,403	1,213,315	11.5%	124,912
SALES	16,066,197	16,116,634	15,007,745	15,738,341	16,211,836	17,387,845	7.3%	1,176,009
CONST	1,848,405	1,784,696	1,737,800	1,708,053	1,931,622	1,713,987	-11.3%	-217,635
PROP	1,942,821	2,120,851	2,165,851	2,330,440	2,620,613	2,530,640	-3.4%	-89,973
TOUR	4,119,921	3,864,807	3,870,460	4,100,792	4,438,396	4,029,358	-9.2%	-409,038
SERV	6,086,537	6,181,099	7,666,826	7,996,623	8,278,021	8,786,293	6.1%	508,272
PROF	1,011,226	919,807	956,798	1,056,782	1,114,031	1,171,430	5.2%	57,399
UTIL	5,546,791	5,770,580	6,249,975	7,137,578	10,767,958	10,445,007	-3.0%	-322,951
MANU	516,798	467,472	552,106	589,261	586,935	563,466	-4.0%	-23,469
TRAN	425,107	463,049	530,115	613,473	632,842	830,903	31.3%	198,061
WHLS	3,387,037	4,299,606	5,437,244	6,390,100	7,286,491	8,026,911	10.2%	740,420
GOV	16,550	39,501	18,063	10,330	7,500	5,790	-22.8%	-1,710
TOTAL	42,247,807	43,041,546	45,404,681	48,701,794	54,964,648	56,704,945	3.2%	1,740,297

Table 7.7

For complete listing of Lines of Business, see page 13

Other KPB 4th Quarter TAXABLE Sales History	
2002	42,247,807
2003	43,041,546
2004	45,404,681
2005	48,701,794
2006	54,964,648
2007	56,704,945

Table 7.8

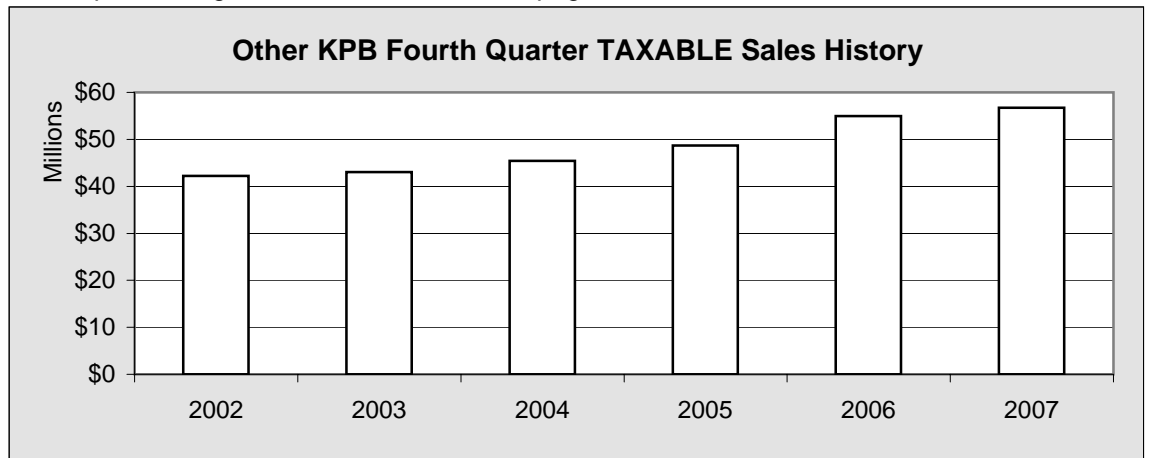

Chart 7.12

Other KPB Five Year Change 4th Quarter TAXABLE Sales		
LOB	2002	2007
RSRC	1,280,417	1,213,315
SALES	16,066,197	17,387,845
CONST	1,848,405	1,713,987
PROP	1,942,821	2,530,640
TOUR	4,119,921	4,029,358
SERV	6,086,537	8,786,293
PROF	1,011,226	1,171,430
UTIL	5,546,791	10,445,007
MANU	516,798	563,466
TRAN	425,107	830,903
WHLS	3,387,037	8,026,911
GOV	16,550	5,790

Table 7.9

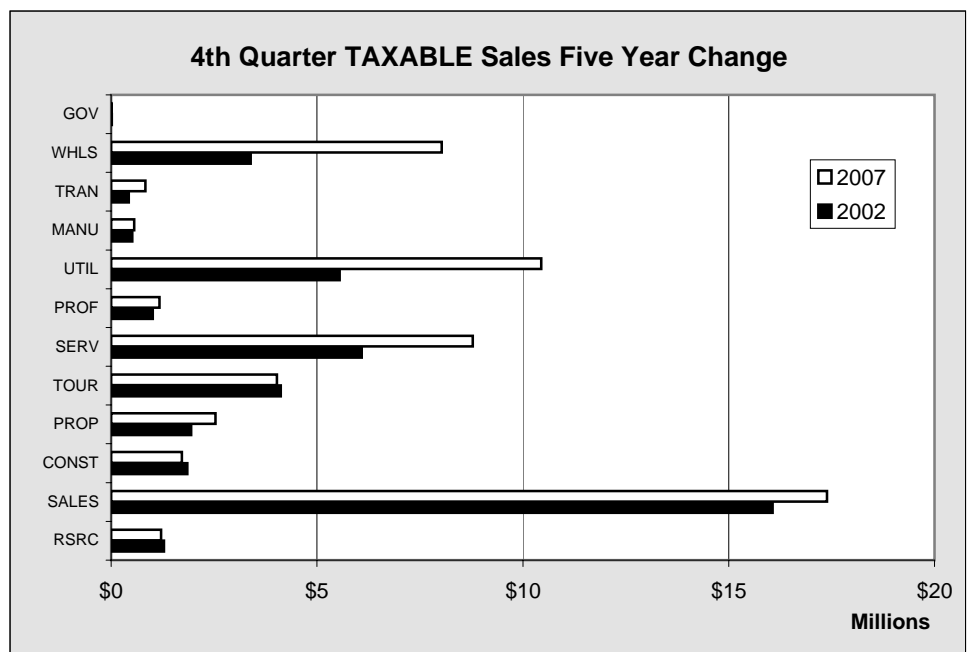

Chart 7.13

Other KPB Sales

Other KPB Annual GROSS Sales by Line of Business - 2002-2007 - in \$

LOB	2002	2003	2004	2005	2006	2007	Annual Percent Change	Annual Amount Change
RSRC	168,795,897	174,817,405	148,481,619	156,122,308	176,799,247	137,374,039	-22.3%	-39,425,208
SALES	203,347,056	182,477,759	139,491,426	141,468,713	155,334,890	166,562,679	7.2%	11,227,789
CONST	118,265,414	121,698,038	120,069,245	125,808,036	153,294,723	146,629,305	-4.3%	-6,665,418
PROP	21,455,183	24,193,998	24,437,091	25,833,025	28,596,694	30,378,374	6.2%	1,781,680
TOUR	41,663,946	41,034,764	45,718,492	47,300,114	52,395,087	53,346,951	1.8%	951,864
SERV	49,860,839	42,711,156	61,599,085	61,992,877	68,345,011	81,992,977	20.0%	13,647,966
PROF	14,684,211	15,800,255	17,160,184	16,948,033	21,110,001	22,053,575	4.5%	943,574
UTIL	38,753,031	33,607,375	36,341,683	43,002,998	50,882,374	62,564,430	23.0%	11,682,056
MANU	95,630,984	85,913,707	131,516,163	187,502,018	121,569,070	144,381,158	18.8%	22,812,088
TRAN	42,819,566	37,266,683	58,773,824	61,150,909	62,557,452	52,575,988	-16.0%	-9,981,464
WHLS	67,490,967	101,925,816	314,154,092	328,361,091	358,627,999	383,493,292	6.9%	24,865,293
GOV	362,327	831,604	1,063,212	820,042	512,629	139,082	-72.9%	-373,547
TOTAL	863,129,421	862,278,560	1,098,806,116	1,196,310,164	1,250,025,177	1,281,491,850	2.5%	31,466,673

Table 7.10 For complete listing of Lines of Business, see page 13

Other KPB Annual GROSS Sales History	
2002	863,129,421
2003	862,278,560
2004	1,098,806,116
2005	1,196,310,164
2006	1,250,025,177
2007	1,281,491,850

Table 7.11

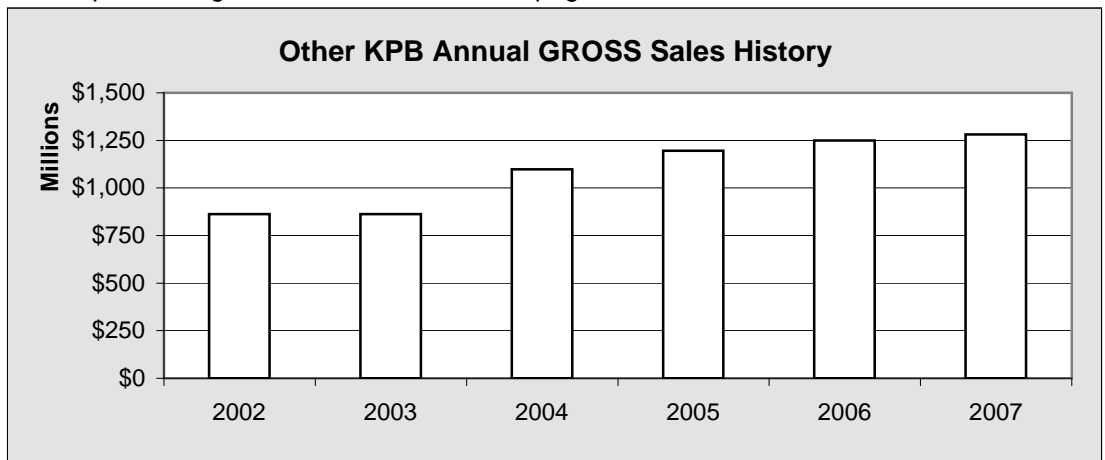

Chart 7.14

Five Year Change Annual GROSS Sales		
LOB	2002	2007
RSRC	168,795,897	137,374,039
SALES	203,347,056	166,562,679
CONST	118,265,414	146,629,305
PROP	21,455,183	30,378,374
TOUR	41,663,946	53,346,951
SERV	49,860,839	81,992,977
PROF	14,684,211	22,053,575
UTIL	38,753,031	62,564,430
MANU	95,630,984	144,381,158
TRAN	42,819,566	52,575,988
WHLS	67,490,967	383,493,292
GOV	362,327	139,082

Table 7.12

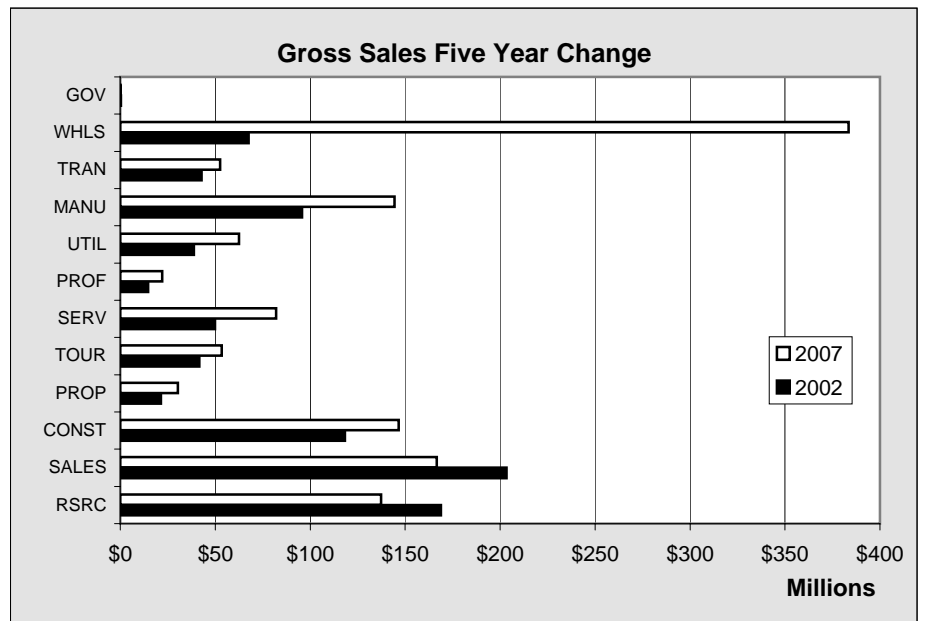

Chart 7.15

Other KPB Sales

Other KPB Annual TAXABLE Sales by Line of Business - 2002-2007 - in \$								
LOB	2002	2003	2004	2005	2006	2007	Annual Percent Change	Annual Amount Change
RSRC	5,902,091	5,190,480	5,440,162	4,671,321	4,859,599	5,526,932	13.7%	667,333
SALES	70,082,144	72,262,016	68,428,498	68,938,432	74,266,350	79,934,763	7.6%	5,668,413
CONST	7,360,920	7,351,364	7,079,159	6,823,512	7,374,261	7,697,997	4.4%	323,736
PROP	8,326,759	8,944,984	8,838,849	9,289,805	10,652,455	11,724,128	10.1%	1,071,673
TOUR	35,122,685	35,508,401	38,541,650	39,979,008	43,767,058	46,510,228	6.3%	2,743,170
SERV	29,017,145	24,765,291	28,118,433	32,245,224	34,167,446	36,894,228	8.0%	2,726,782
PROF	4,226,537	4,040,814	4,117,450	4,291,437	4,660,089	5,230,385	12.2%	570,296
UTIL	22,103,843	22,028,897	22,820,720	26,157,508	32,958,620	41,516,224	26.0%	8,557,604
MANU	2,861,063	2,571,709	2,618,074	3,236,915	3,162,719	3,341,402	5.6%	178,683
TRAN	11,454,019	11,545,972	12,725,505	14,177,577	13,888,946	21,531,827	55.0%	7,642,881
WHLS	14,274,026	15,473,834	19,787,056	22,775,440	26,747,293	28,290,249	5.8%	1,542,956
GOV	18,050	39,501	30,667	50,936	15,303	26,808	75.2%	11,505
TOTAL	210,749,282	209,723,263	218,546,223	232,637,115	256,520,139	288,225,171	12.4%	31,705,032

Table 7.13

For complete listing of Lines of Business, see page 13

Other KPB Annual TAXABLE Sales History	
2002	210,749,282
2003	209,723,263
2004	218,546,223
2005	232,637,115
2006	256,520,139
2007	288,225,171

Table 7.14

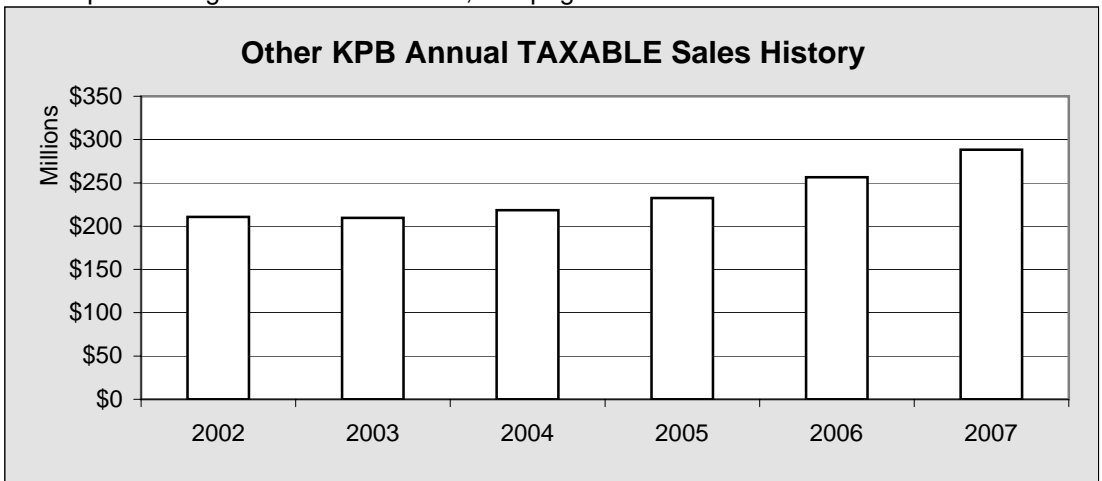

Chart 7.16

Five Year Change Annual TAXABLE Sales		
LOB	2002	2007
RSRC	5,902,091	5,526,932
SALES	70,082,144	79,934,763
CONST	7,360,920	7,697,997
PROP	8,326,759	11,724,128
TOUR	35,122,685	46,510,228
SERV	29,017,145	36,894,228
PROF	4,226,537	5,230,385
UTIL	22,103,843	41,516,224
MANU	2,861,063	3,341,402
TRAN	11,454,019	21,531,827
WHLS	14,274,026	28,290,249
GOV	18,050	26,808

Table 7.15

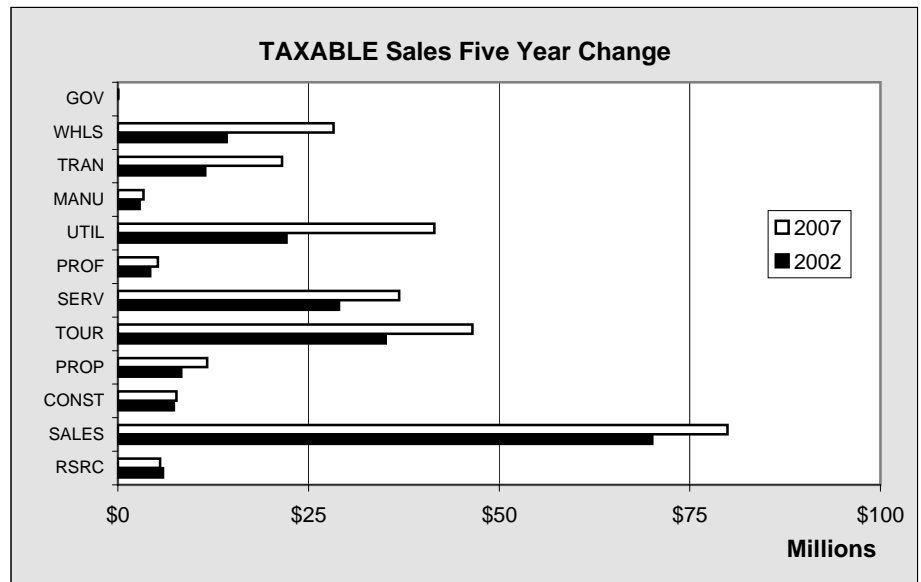

Chart 7.17

Other KPB Sales

Other KPB GROSS Sales by Line of Business by Quarter - 2007 - in \$					
LOB	1st Quarter	2nd Quarter	3rd Quarter	4th Quarter	Total
Resource Production	24,173,429	33,892,210	39,514,243	39,794,157	137,374,039
Sales	31,036,619	46,938,560	50,531,665	38,055,835	166,562,679
Construction	24,674,537	37,290,807	54,131,328	30,532,633	146,629,305
Property	6,000,498	8,027,234	9,372,486	6,978,156	30,378,374
Tourism	5,333,381	14,708,237	28,850,177	4,455,156	53,346,951
Services	16,819,887	21,203,810	23,546,252	20,423,028	81,992,977
Professional	4,900,707	5,367,286	6,569,287	5,216,295	22,053,575
Utility	19,670,793	13,920,583	13,624,573	15,348,481	62,564,430
Manufacturing	36,581,475	29,655,389	51,743,460	26,400,834	144,381,158
Transporation & Warehousing	5,270,755	14,708,038	25,505,756	7,091,439	52,575,988
Wholesale	25,345,211	29,203,206	35,863,023	293,081,852	383,493,292
Government	25,127	7,764	12,940	93,251	139,082
TOTAL	199,832,419	254,923,124	339,265,190	487,471,117	1,281,491,850

Table 7.16

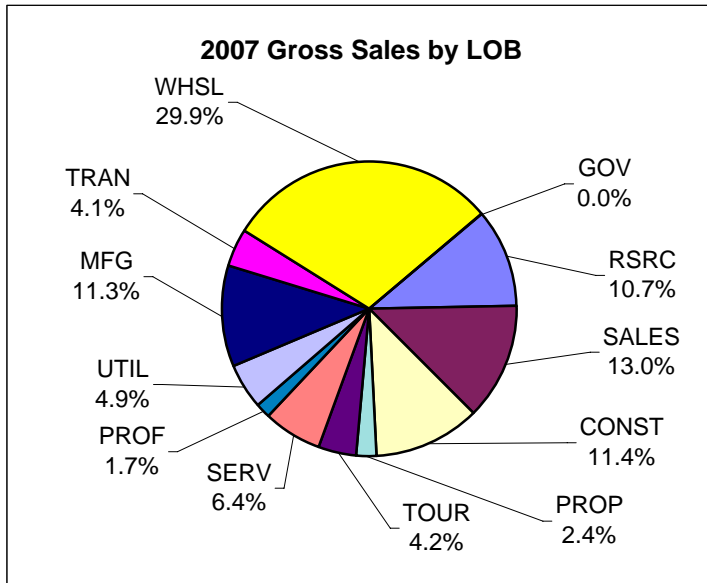

Chart 7.18

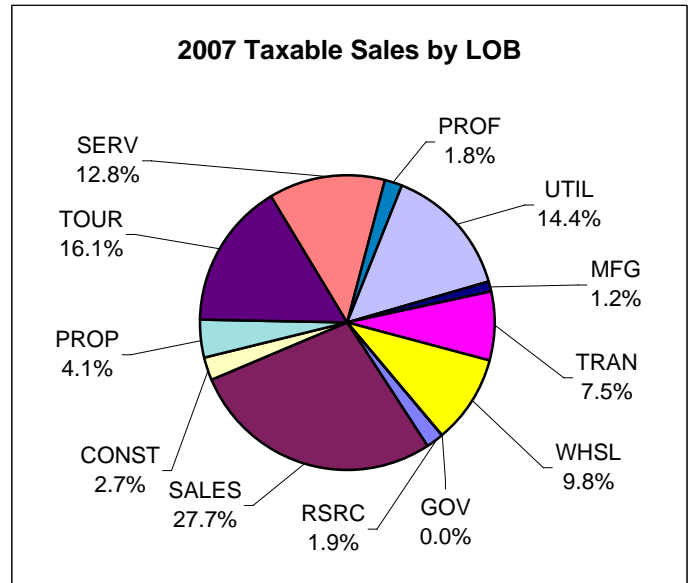

Chart 7.19

Other KPB TAXABLE Sales by Line of Business by Quarter - 2007 - in \$					
LOB	1st Quarter	2nd Quarter	3rd Quarter	4th Quarter	Total
Resource Production	848,803	1,831,597	1,633,217	1,213,315	5,526,932
Sales	13,656,197	22,226,759	26,663,962	17,387,845	79,934,763
Construction	1,377,850	2,027,991	2,578,169	1,713,987	7,697,997
Property	2,252,920	3,052,854	3,887,714	2,530,640	11,724,128
Tourism	3,877,592	13,552,450	25,050,828	4,029,358	46,510,228
Services	7,573,446	9,752,950	10,781,539	8,786,293	36,894,228
Professional	1,162,672	1,361,068	1,535,215	1,171,430	5,230,385
Utility	14,066,725	9,309,759	7,694,733	10,445,007	41,516,224
Manufacturing	404,818	1,021,490	1,351,628	563,466	3,341,402
Transporation & Warehousing	526,097	6,545,941	13,628,886	830,903	21,531,827
Wholesale	7,055,149	6,331,399	6,876,790	8,026,911	28,290,249
Government	12,918	3,500	4,600	5,790	26,808
TOTAL	52,815,187	77,017,758	101,687,281	56,704,945	288,225,171

Table 7.17

Other KPB Sales

Other KPB GROSS Sales by Line of Business by Quarter - 2006 - in \$					
LOB	1st Quarter	2nd Quarter	3rd Quarter	4th Quarter	Total
Resource Production	40,220,280	42,117,493	61,058,914	33,402,560	176,799,247
Sales	26,393,759	44,969,521	47,888,770	36,082,840	155,334,890
Construction	17,664,680	27,155,527	46,458,096	62,016,420	153,294,723
Property	5,276,018	7,511,584	8,669,030	7,140,062	28,596,694
Tourism	4,084,983	15,124,072	28,124,789	5,061,243	52,395,087
Services	13,973,046	16,852,701	18,771,090	18,748,174	68,345,011
Professional	4,310,305	4,645,860	5,499,178	6,654,658	21,110,001
Utility	14,204,879	10,777,719	10,142,989	15,756,787	50,882,374
Manufacturing	14,118,527	41,652,493	43,806,075	21,991,975	121,569,070
Transporation & Warehousing	6,820,560	18,361,853	27,579,341	9,795,698	62,557,452
Wholesale	25,362,523	32,313,057	38,050,883	262,901,536	358,627,999
Government	116,915	30,523	32,688	332,503	512,629
TOTAL	172,546,475	261,512,403	336,081,843	479,884,456	1,250,025,177

Table 7.18

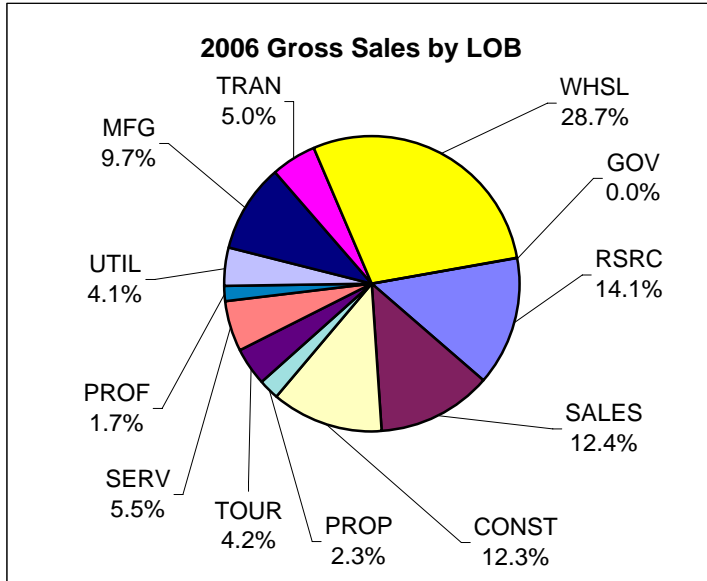

Chart 7.20

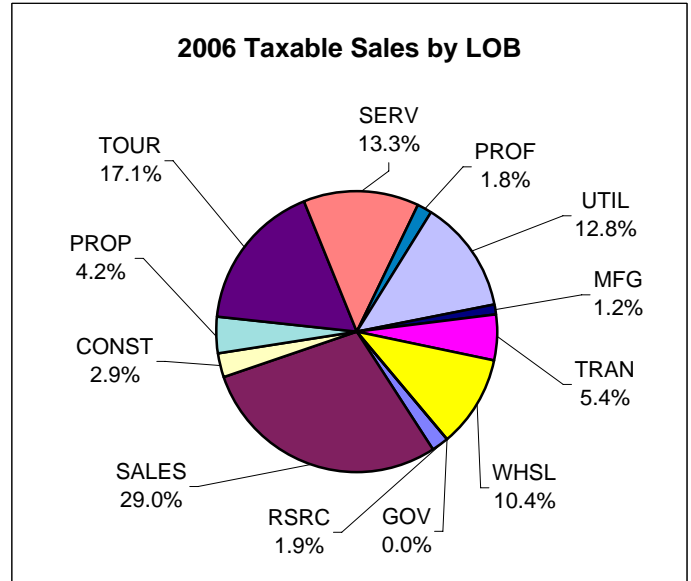

Chart 7.21

Other KPB TAXABLE Sales by Line of Business by Quarter - 2006 - in \$					
LOB	1st Quarter	2nd Quarter	3rd Quarter	4th Quarter	Total
Resource Production	817,940	1,618,533	1,334,723	1,088,403	4,859,599
Sales	13,151,600	20,835,726	24,067,188	16,211,836	74,266,350
Construction	1,194,972	1,983,665	2,264,002	1,931,622	7,374,261
Property	2,094,938	2,624,473	3,312,431	2,620,613	10,652,455
Tourism	3,832,809	12,836,632	22,659,221	4,438,396	43,767,058
Services	7,092,645	8,874,122	9,922,658	8,278,021	34,167,446
Professional	1,105,820	1,242,207	1,198,031	1,114,031	4,660,089
Utility	9,589,952	6,739,938	5,860,772	10,767,958	32,958,620
Manufacturing	385,935	861,820	1,328,029	586,935	3,162,719
Transporation & Warehousing	473,725	4,553,351	8,229,028	632,842	13,888,946
Wholesale	6,219,778	6,165,135	7,075,889	7,286,491	26,747,293
Government	1,500	3,279	3,024	7,500	15,303
TOTAL	45,961,614	68,338,881	87,254,996	54,964,648	256,520,139

Table 7.19

Other KPB Sales

Other KPB GROSS Sales by Line of Business by Quarter - 2005 - in \$					
LOB	1st Quarter	2nd Quarter	3rd Quarter	4th Quarter	Total
Resource Production	36,538,406	32,984,277	38,678,299	47,921,326	156,122,308
Sales	23,916,370	41,797,052	43,648,109	32,107,182	141,468,713
Construction	18,506,019	26,551,092	36,203,660	44,547,265	125,808,036
Property	4,281,988	6,518,043	7,599,208	7,433,786	25,833,025
Tourism	3,709,869	14,032,029	25,108,636	4,449,580	47,300,114
Services	12,371,018	15,118,937	16,872,155	17,630,767	61,992,877
Professional	3,641,426	3,829,282	4,360,262	5,117,063	16,948,033
Utility	11,994,977	9,588,169	9,761,658	11,658,194	43,002,998
Manufacturing	26,699,106	46,385,401	83,218,366	31,199,145	187,502,018
Transporation & Warehousing	8,011,943	16,387,525	26,713,775	10,037,666	61,150,909
Wholesale	33,200,844	28,340,752	33,896,804	232,922,691	328,361,091
Government	172,954	53,661	111,945	481,482	820,042
TOTAL	183,044,920	241,586,220	326,172,877	445,506,147	1,196,310,164

Table 7.20

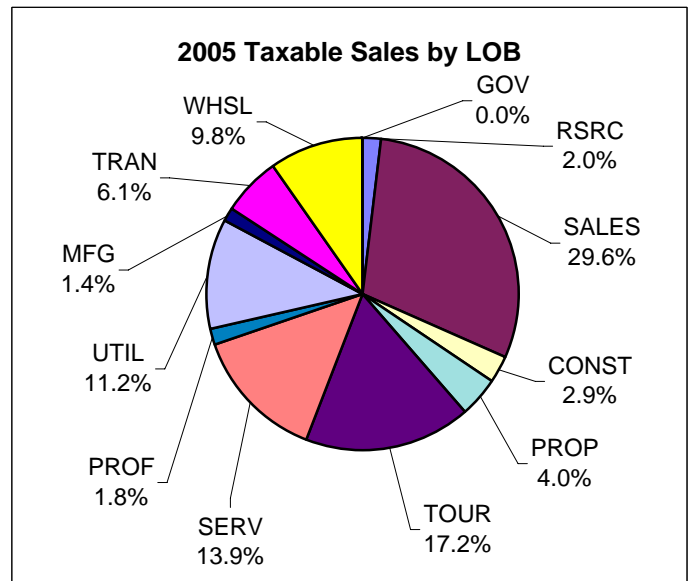
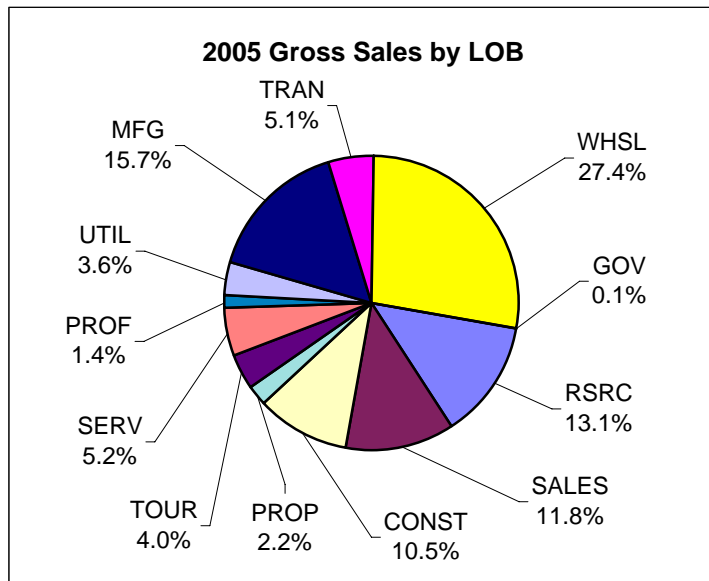

Chart 7.22

Chart 7.23

Other KPB TAXABLE Sales by Line of Business by Quarter - 2005 - in \$					
LOB	1st Quarter	2nd Quarter	3rd Quarter	4th Quarter	Total
Resource Production	894,075	1,603,774	1,143,451	1,030,021	4,671,321
Sales	11,867,506	19,210,896	22,121,689	15,738,341	68,938,432
Construction	1,156,435	1,877,577	2,081,447	1,708,053	6,823,512
Property	1,813,926	2,377,591	2,767,848	2,330,440	9,289,805
Tourism	3,487,011	12,094,385	20,296,820	4,100,792	39,979,008
Services	6,990,386	8,316,241	8,941,974	7,996,623	32,245,224
Professional	991,452	1,140,272	1,102,931	1,056,782	4,291,437
Utility	7,721,399	5,915,426	5,383,105	7,137,578	26,157,508
Manufacturing	371,358	885,842	1,390,454	589,261	3,236,915
Transporation & Warehousing	446,209	4,814,809	8,303,086	613,473	14,177,577
Wholesale	5,372,788	5,020,486	5,992,066	6,390,100	22,775,440
Government	21,317	4,448	14,841	10,330	50,936
TOTAL	41,133,862	63,261,747	79,539,712	48,701,794	232,637,115

Table 7.21

Local Officials Directory

Kenai Peninsula Borough officials of the various governing bodies are listed on the following pages.

Officials listed are those who held office at the time of printing the report. Annual elections for public officials are held each October. For information regarding current public officials, check the appropriate website.

Kenai Peninsula Borough – <http://www.borough.kenai.ak.us/>

Kenai Peninsula Borough School District – <http://www.kpbsd.k12.ak.us/>

City of Homer – <http://www.ci.homer.ak.us/>

City of Kenai – <http://www.ci.kenai.ak.us/>

City of Seldovia – <http://www.cityofseldovia.com/>

City of Seward – <http://www.cityofseward.net/>

City of Soldotna – <http://www.ci.soldotna.ak.us/>

Local Officials Directory

Kenai Peninsula Borough Mayors

Kenai Peninsula Borough

Mayor John J. Williams 144 North Binkley
Soldotna, AK 99669
907-262-4441

City of Homer

Mayor Jim Hornady 491 East Pioneer Ave.
Homer, AK 99603
907-235-8121

City of Kachemak

Mayor Philemon Morris PO Box 958
Homer, AK 99603
907-235-8897

City of Kenai

Mayor Pat Porter 210 Fidalgo Street, Suite 200
Kenai, AK 99611
907-283-7535

City of Seldovia

Mayor Dick Wyland Drawer B
Seldovia, AK 99663
907-234-7643

City of Seward

Mayor Clark Corbridge PO Box 167
Seward, AK 99664
907-224-4046

City of Soldotna

Mayor Dave Carey 177 North Birch
Soldotna, AK 99669
907-262-9107

Table 8.1

Local Officials Directory

Kenai Peninsula Borough Mayor & Assembly				
144 N. Binkley Soldotna, Alaska 99669 Phone 907-714-2160 Assembly/Clerk Fax: 907-714-2388 Assembly e-mail: assemblyclerk@borough.kenai.ak.us				
Office / District	Name / Address	Phone / Fax / E-Mail	Term Expires	Previously Elected
Borough Mayor	John Williams 144 N. Binkley St. Soldotna, AK 99669	714-2150 W 283-4960 H 262-8616 F jwilliams@borough.kenai.ak.us	2008	2005
Assembly 1 Kalifornsky	Gary Knopp 50465 Patrick Drive Kenai, AK 99611	283-9494 H 283-9800 F pa12gary@hotmail.com	2009	2006
Assembly 2 Kenai	Margaret Gilman - Vice President 216 Susieana Lane Kenai, AK 99611	283-0860 H mbgilman@gci.net	2008	2005
Assembly 3 Nikiski	Gary Superman P.O. Box 8425 Nikiski, AK 99635	776-8448 H 776-8098 F 252-5264 W gsuperman@gci.net	2010	1989, 2001, 2004
Assembly 4 Soldotna	Pete Sprague 188 Farnsworth Blvd. Soldotna, AK 99669	262-4073 H 262-8615 F psprague@acsalaska.net	2010	1998, 2001, 2002, 2004
Assembly 5 - Sterling / Funny River	Grace Merkes P.O. Box 8 Sterling, AK 99672	262-9811 H merkes2@yahoo.com	2008	1991, 1992, 1993, 1996, 1999, 2002, 2005
Assembly 6 East Peninsula	Ron Long - President P.O. Box 2464 Seward, AK 99664	224-7068 H 224-5707 F rlms@ptialaska.net	2009	2000, 2003, 2006
Assembly 7 Central	Paul Fischer P.O. Box 889 Kasilof, AK 99610	262-9269 H 262-4902 F akifischer@hotmail.com	2010	1998, 2001, 2002, 2004
Assembly 8 Homer	Bill Smith P.O. Box 150 Homer, AK 99603	235-8932 H bsmith@xyz.net	2008	
Assembly 9 South Peninsula	Milli Martin P.O. Box 2652 Homer, AK 99603	235-6652 H 235-6652 F millimom@xyz.net	2009	2000, 2002, 2003, 2006
Borough Clerk	Sherry Biggs 144 N. Binkley St. Soldotna, AK 99669	714-2160 262-8615 Fax assemblyclerk@borough.kenai.ak.us		

Table 8.2

Local Officials Directory

KENAI PENINSULA BOROUGH		
PLANNING COMMISSION MEMBERS		
2006		
Member	Contact Information	Term Expires
CHAIRMAN Philip Bryson P.O. Box 1041 Kenai, Alaska 99611-1041	283-4672 work 283-4428 home	Kenai City Term Expires July 31, 2010
VICE CHAIRMAN Blair Martin P.O. Box 1776 Soldotna, Alaska 99669-1776	283-5227 - home	Kalifornsky Beach Term Expires July 31, 2009
JoAnne Collins P.O. Box 341 Anchor Point, Alaska 99556-0962	235-8071 home	Anchor Point/Ninilchik Term Expires July 31, 2010
Linda Murphy P.O. Box 4124 Soldotna, Alaska 99669	262-1686 - home	Soldotna City Term Expires July 31, 2008
Dr. Rick Foster P.O. Box 3328 Homer, AK 99603-3328	235-9100 - home	Homer City Term Expires July 31, 2010
Mari Anne Gross 57485 Clover Avenue Homer, Alaska 99603	235-7330 - home	Southwest Borough Term Expires July 31, 2008
Vacant		Seward City
Harry Lockwood 37085 Rafie Court Soldotna, Alaska 99669		Ridgeway Term Expires July 31, 2010
James Isham P.O. Box 51 Soldotna, Alaska 99669-0051	262-9200 - home	Sterling Term Expires July 31, 2009
Brent Johnson 20773 Porcupine Lane Clam Gulch, Alaska 99568-9713	262-4763 - home	Kasilof/Clam Gulch Term Expires July 31, 2009
Paulette Bokenko-Carluccio P.O. Box 116 Seldovia, Alaska 99663-0278	37227575 - home	Seldovia City Term Expires July 31, 2009
Todd Petersen P.O. Box 651 Seward, Alaska 99664-0651	288-5050 - home 224-3350 - work 224-2388 - work fax	East Peninsula Term Expires July 31, 2010
Ray Tauriainen P.O. Box 8678 Nikiski, Alaska 99635-8678	776-8885 - home	Northwest Borough Term Expires July 31, 2008

Email address for the Planning Commission: planning@borough.kenai.ak.us

Fax Number for the Planning Commission: 907-262-8618

Table 8.3

Local Officials Directory

Kenai Peninsula Borough School District			
148 North Binkley Street Soldotna, AK 99669 907-262-5846			
<u>Board of Education</u>			
Sammie Crawford President	36615 Chinulna Drive Kenai, AK 99611	904-283-9271	Term Expires 2010
Elizabeth Downing Vice President	1247 Bay Avenue Homer, AK 99603	907-235-8555	Term Expires 2009
Lynn Hohl	P.O. Box 333 Seward, AK 99664	907-224-7300	Term Expires 2010
Bill Hatch	P.O. Box 2305 Kenai, AK 99611	907-283-5122	Term Expires 2009
Marty Anderson	P.O. Box 1388 Sterling, AK 99672	907-260-7500	Term Expires 2009
Nels Anderson, MD	303 Diane Lane Soldotna, AK 99669	907-262-3280	Term Expires 2008
Debbie Brown	P.O. Box 592 Kasilof, AK 99610	907-262-4551	Term Expires 2008
Debra Mullins	53630 Redoubt Dr. Kenai, AK 99611	907-776-5250	Term Expires 2008
Sunni Hilts	P.O. Box 144 Seldovia, AK 99663	907-234-7692	Term Expires 2010
Student Representative Brittany Meyer	Skyview High School 46188 Sterling Highway Soldotna, AK 99669		Term Expires 9/2008

Table 8.4

<u>Administration</u>
Dr. Donna Peterson, Superintendent of Schools Glen Szymoniak, Assistant Superintendent Dave Jones, Assistant Superintendent of Instruction Melody Douglas, Chief Financial Officer

Table 8.5

Local Officials Directory

Kenai Peninsula Borough Department Directors	
Switchboard	(907) 262-4441 or (800) 478-4441
Assessing	Shane Horan
Capital Projects	Kevin Lyon
Clerk	Sherry Biggs
Finance	Craig Chapman
Legal	Colette Thompson
Maintenance	Bill Kopecky
Resource Planning	Max Best
Road Maintenance	Gary Davis
Solid Waste	Bob Garlock

Table 8.6

Kenai Peninsula Borough Economic Development Agencies
<p>Kenai Peninsula Economic Development District - EDD 14790 Kenai Spur Highway, Ste. 106A Kenai, AK 99611 907-283-3335</p>
<p>Kenai Peninsula Tourism Marketing Council - KPTMC 35477 Kenai Spur Highway, Ste. 205 Soldotna AK 99669 907-262-5229</p>
<p>Kenai Peninsula Resource Conservation and Development, Inc. Trading Bay Plaza, Suite 150 PO Box 800, Kenai, AK 99611 907-283-7493</p>

Table 8.7

RECYCLE * RECYCLE * RECYCLE

Please recycle this document by removing the binding edge and depositing the mixed paper at a recycling collection station. The document can also be returned to the Borough Print Shop for edge removal and recycling.

**KENAI
PENINSULA
BOROUGH**

HOMER

KENAI

SELDOVIA

SEWARD

SOLDOTNA

OTHER KBP

**DIRECTORY
OF LOCAL
OFFICIALS**